

Environmental Protection Plan
Sheboygan River and Harbor Superfund Site
Sheboygan County, Wisconsin

March 2011

Revised February 2012

Prepared By

Pollution Risk Services, LLC



TABLE OF CONTENTS

1.0	INTRODUCTION	1
2.0	RESPONSIBILITIES	2
3.0	ENVIRONMENTAL MONITORING	3
4.0	METHOD OF PROTECTION	4
5.0	SOLID WASTE DISPOSAL	6
6.0	CHEMICAL WASTE DISPOSAL	7
7.0	WORK AREAS	8

APPENDICES

- Appendix A: Spill Prevention Plan
- Appendix B: Fish and Wildlife Resources Documentation
- Appendix C: Cultural, Historical, and Archeological Resources Documentation
- Appendix D: Sign-off Acknowledgement Form

1.0 INTRODUCTION

The Environmental Protection Plan (EPP) has been prepared to document environmental management activities to be implemented as part of Sediment Removal remedial actions required at the Sheboygan River and Harbor Superfund Site, Sheboygan County, Wisconsin. Remedial activities are required to be implemented as set forth in the Record of Decision (ROD), Consent Decree (CD), and Lower River Statement of Work (LRSOW).

It is the intent of this program to prevent environmental pollution or damage during and as a result of construction operations. It is the policy to develop the Environment Protection Plan in conjunction with all federal, state, and local laws, and regulations, as well as the Specifications. This plan includes the elimination or limitation of chemicals, physical or biological elements or agents that adversely affect human health or welfare; unfavorably alter ecological balances of importance to human life, affect other species of importance to man; or degrade the utilities of the environment for aesthetic and recreational purposes. Preservation of land, water, and fish/wildlife resources within the project boundaries and outside the limits of permanent work performed will be a priority.

The following laws and regulations in whole or part are pertinent to this project:

1. Fish and Wildlife Act of 1956
2. Fish and Wildlife Coordination Act of 1958
3. National Historic Preservation Act of 1966
4. National Environmental Policy Act of 1969
5. Endangered Species Act of 1973
6. Clean Water Act of 1977
7. Clean Air Act
8. Comprehensive Environmental Response, Compensation, and Liability Act
9. Wisconsin Pollution Discharge Elimination System
10. Toxic Substance Control Act

The Project Team will establish and maintain environmental protection of all items set for in the Specifications. They will record and maintain field reports of any problems in complying with laws, regulations, and ordinances. Immediate corrective actions will be taken to correct pollution of or damage to the environment due to accident, natural causes, or failure to follow the procedures set out in our environmental protection plan.

2.0 RESPONSIBILITIES

The Project Manager (or designee) will be responsible for the execution of the EPP and will include the following:

1. Ensuring adherence to the Environmental Protection Plan;
2. Manifesting TSCA and non-TSCA waste to be removed from the site, and
3. Training personnel in accordance with the requirements of this plan.

3.0 ENVIRONMENTAL MONITORING

All team members have been trained through practical experience and instructions received on methods of detecting and avoiding pollution, familiarization with pollution standards, installation and care of facilities to insure adequate and continuous environmental pollution control and methods of protecting environmental resources from damage. Each individual is responsible for his/her sphere of operations.

4.0 METHOD OF PROTECTION

A. Water Resources

The Project Team will keep dredge and dredge slurry operation activities under surveillance, management, and control to prevent pollution from entering ground, drainage, or local bodies of water.

The dredge and dredge slurry operation will be conducted in a manner to minimize turbidity and conform to all applicable water quality standards. Constant radio contact will allow for quick notification should the dredge and dredge slurry operations exceed water quality standards.

The Project Team will take measures to prevent spills from:

- Fuel leaks
- Oil leaks
- Dredge and dredge slurry piping

Immediate actions will be taken to contain and clean up any spill of oily substance, contaminated water, and petroleum products. Booms, absorbent pads, and absorbent dry will be used to contain and clean-up any spills. They will be made available on the dredge, booster pumps, fuel boat, and dewatering area outside the flood zone. Any spills or exceeded water quality standard will be immediately reported to the Project Manager. Reportable quantities will be reported to the National Response Center (NRC), United States Environmental Protection Agency (USEPA), and Wisconsin Department of Natural Resources (WDNR). A Spill Prevent Plan is included as Appendix A.

B. Fish & Wildlife Resources

The Project Team will keep remediation activities under surveillance, management, and control to minimize interference with, disturbance to, and damage to fish and wildlife. Notification to the WDNR has been made and is documented in Appendix B.

C. Cultural, Historical, and Archaeological Resources

An archeological investigation of the Graham Brothers Schooner shipwreck in the Sheboygan River has been conducted. Documentation is provided in Appendix C. To preserve this historic property, the following procedures will be implemented:

- Inform all dredging personnel that there is a Historical location within the river and that a 10' work offset boundary is in place, as recommended in the Archaeological Investigation No. 778.
- Dredge sediment near the Historical area with GPS guided machinery with a computer monitor identifying the offset locations for the dredge operator.

- Place physical markers in the river at the offset boundaries before any sediment removal work is performed within 500 feet of the Historical location.
- Monitor all sediment removal activity within 40 feet of the Historical areas with a Quality technician. The technician will have sight lines of the dredge operator and the physical offset markers.

D. Air Resources

The Project Team will keep remediation activities under surveillance, management, and control to minimize pollution of air resources. All activities, equipment, process and work operated or performed in accomplishing this project will be in strict accordance with the applicable air pollution standards. All diesel engines used on this project are maintained at the highest acceptable industrial standards for operating to prevent air pollution. If any engine runs poorly, it will be repaired to meet proper pollution standards. In addition, air monitoring will be performed to evaluate fugitive dust emissions during each sediment load-out phase or anytime there is visible dust in accordance with the Verification Sampling Plan. Any exceeded air quality standard will be immediately reported to the Project Manager or designee, who will then notify the USEPA and WDNR. Additional detail is provided in the Sediment Management Plan found in Appendix E.

E. Sound Resources

The Project Team will keep construction activities under surveillance and control to minimize damage to the environment by noise. The dredge, booster pumps, and Wastewater Treatment Plant (WWTP) pumps will be equipped with noise reducing mufflers.

5.0 SOLID WASTE DISPOSAL

Solid waste (i.e. general trash) will be collected daily, as part of housekeeping, into plastic lined containers. The solid waste will be transported and deposited in accordance with all laws regarding the disposal of solid waste.

6.0 CHEMICAL WASTE DISPOSAL

Chemical waste (i.e. used oil and fluids) will be stored in corrosion resistant containers and disposed in accordance with federal, state, and local regulations.

7.0 WORK AREAS

Personnel will be instructed not to work outside the designated dredge and dredge slurry operation areas so as not to disturb surrounding vegetation and wildlife.

All personnel will be made aware of and understand the contents of this entire Environmental Protection Plan. The team will conduct worker-training sessions to acquaint all personnel with all phases of the Environmental Protection Plan. A sign-off sheet as provide in Appendix D will document the worker-training sessions.

GENERAL INFORMATION

VESSELS AND EQUIPMENT ON PROJECT: (1) 10" Diesel Swing and Ladder Dredge; (2) 10" Diesel Skid Mounted Booster Pump; (1) Clamshell Bucket Dredge – Cover Placement; (3) 550 gallon double-wall diesel fuel tanks; (1) 150 gallon double-wall fuel boat; (1) Diesel Telehandler; (1) Diesel Excavator; (1) Diesel Front-end Loader; (2) Maintenance boat with gas powered outboard engine; (1) Personnel Jon boat with gas powered outboard engine; (1) Pontoon sampling boat with gas powered outboard engine; (3) Diesel Wastewater Treatment Plant Pumps; (1) Polymer Injection System; (4) Multi-media/Sand Vessels; (4) Granulated Activated Carbon Vessels; (1) 22,000 Effluent Storage Tank.

The equipment on this project powered with diesel engines are fueled by #2 diesel fuel. The equipment on this project powered with gas engines are fueled with unleaded gasoline. Diesel fuel, unleaded gasoline, and oil/lubricants will be stored in a secured location outside the flood zone.

A polymer system will be used to inject polymer into the dredge slurry to aid in the dewatering process. Only 1,500 gallons of polymer will be on-site at any given time. Polymer will be staged outside the flood zone.

EMERGENCY COORDINATORS

The Emergency Coordinator (EC) is responsible for coordinating all activities with regard to an implementation of the Spill Plan. All emergency activities are under the direct control of the EC or an employee designated by the EC. The emergency coordinator or alternate will be available to respond to an emergency on a 24-hour basis.

The primary EC is the Project Manager who is normally on site from 7:00 am to 5:00 pm Monday through Saturday. The EC or designated alternate will be available to respond to an incident at the project site during any period of operation.

The EC and alternate are very familiar with all operations, locations or records, the layout and fuels/lubricants onboard the vessels. All team members have been instructed to call 911 and then notify the EC immediately in the event of a major spill. The team members have been instructed to notify the EC immediately in the event of a minor spill. A concise description of the appropriate response in case of a spill including the contact information for the EC and alternate is provided below. This information will be displayed on the dredge and at the job trailer.

The EC will assess the severity of the incident and determine the appropriate action necessary to mitigate the release. The EC will immediately notify the National Response Center, USEPA Project Manager, and WDNR Project Manager, if necessary. The agencies and groups that will be notified in the event of an emergency are listed in Table 1 of the emergency contacts section.

The following incidents will warrant a major spill.

- An uncontrolled untreated water spill from the dredge and/or dredge slurry operation
- An uncontrolled discharge of fuel or lubricant

- An uncontrolled off-site release of contaminated sediment

Whenever there is a major spill, call 911. The EC or designee will then immediately:

- Activate communication system to notify personnel;
- Notify appropriate local, state, and federal agencies as listed in Table 1; and
- Identify the material, exact source, amount and the real extent of any released materials and assess possible hazards to human health and the environment that may result from the situation.

Immediately following the emergency situation, the EC will:

- Provide the treatment, storage or disposal of any material recovered or contaminated from the discharge or cleanup;
- See that any material, which is potentially incompatible with the discharge material from the incident area, is removed or protected until cleanup procedures are completed;
- See that emergency equipment is cleaned and fit for its intended use before operations are resumed;
- Notify the appropriate local, state and federal authorities that the above steps have been completed, following the emergency situation;
- Record the time, date and details of incident and file a report as shown in Table 1.

EMERGENCY RESPONSE PROCEDURES

Emergency response procedures have been developed to effectively mitigate any spill that may arise at the project site.

- A. Spill Response Procedures
 1. Stop All Operations;
 2. Call 911, if major spill;
 3. Appraise EC of situation;
 4. Block all possible routes to stop material from spreading; surround spill area; and
 5. Contact the appropriate agencies, if reportable quantity.
- B. Decontamination Procedures
 1. Absorb spilled material with absorbent pads, booms, or absorbent dry.
 2. All disposable clean up equipment (oil dry, booms, and non reusable pads) will be placed in drums as contaminated waste. Label containers as contaminated waste.
 3. Dispose of all recovered wastes and contaminated equipment only at a permitted facility.

EMERGENCY EQUIPMENT

Materials for containing and cleaning up spilled materials from dredging will be located on the fuel boat, dredge, and booster pumps. These materials include absorbent booms, dry, and pads.

Materials for containing and cleaning up spill material at the dewatering area will be located in a secured area outside the flood zone. This includes absorbent pads, booms, and absorbent dry.

Polymer material will be swept clean.

Radios will be available on the dredge, booster pumps, dewatering area and office trailer for summoning assistance in the event of an emergency or spill.

REQUIRED REPORTS

Any emergency requiring activation will be reported to the appropriate local, state, and federal agencies on the spill incident log sheet shown in Table 1.

TABLE 1
SHEBOYGAN RIVER SITE SPILL INCIDENT LOG SHEET

I. Initial Information Required

1.	Name of Informant:	_____
2.	Phone Number:	_____
3.	Location of Spill:	_____
4.	Name of Injured and Type of Injuries (if applicable):	_____
5.	Substance Spilled:	_____
6.	Amount Spilled (estimated):	_____
7.	Extent of Spill:	_____
8.	Rate Material Currently Spilling (if applicable):	_____
9.	Time Spill Occurred (estimated):	_____
10.	Time of Notification(s):	_____
11.	Other information:	_____

II. Spill Notification Sequence and Numbers:

1.	EC Ken A Radio or cell phone: (513) 518-2762	Time: _____
	Alternate Scott McGee Radio or cell phone: (270) 589-9041	
2.	Sheboygan Memorial Medical Center (if workers injured) (920) 451-5553 Hospital Poison Center: 1-800-815-8855	Time: _____
3.	Fire Department and Police Department 911 or (920)929-3700 for State Police	Time: _____
4.	National Response Center (NRC) (if RQ is exceeded) 1-800-424-8802	Time: _____
5.	USEPA Project Manager 1-312-353-2886	Time: _____
6.	WDNR Project Manager 1-920-892-8756 ext. 3028	Time: _____

APPENDIX B
FISH AND WILDLIFE RESOURCES DOCUMENTATION

Reply Reply to all Forward X Close Help

From: Wentland, Thomas A - DNR [Thomas.Wentland@Wisconsin.gov]
To: Ken Aukerman
Cc: Pappas, Victor C - DNR; Zhang, Xiaochun - DNR; valentin.pablo@epa.gov
Subject: Sheboygan River, Endangered Resource Data Base Evaluation
Attachments:

Sent: Mon 2/14/2011 4:37 PM

[View As Web Page](#)

I have reviewed the Department of Natural Resources' data base for the presence of endangered resources in the area of the Sheboygan River that is to be dredged as part of the Lower River segment of the Superfund project. The final design for this phase of the project was approved by EPA on December 9, 2010. More specifically my evaluation included an evaluation of the Sections 22, 23, 26, 27, and 28 of T15N, R23E of Sheboygan County. Based on the evaluation I have concluded that there are no aquatic endangered resources in the project area.

Thomas A. Wentland
Dept. of Natural Resources
Plymouth Service Center
1155 Pilgrim Road
Plymouth, WI 53073
920-892-8756 Ex. 3018

APPENDIX C
CULTURAL, HISTORICAL, AND ARCHEOLOGICAL RESOURCES
DOCUMENTATION

**An Archaeological Investigation of the
Graham Brothers Schooner Shipwreck
(47SB0333) in the Sheboygan River, City of
Sheboygan, Wisconsin**

**Sheboygan River Legacy Act Dredging Project, Sheboygan County,
Wisconsin**

Prepared By: Richard Kubicek, Principal Investigator
Kevin Cullen, Underwater Archaeological Consultant
Great Lakes Archaeological Research Center, Inc.
1408 North 5th Street
Milwaukee, WI 53212

GLARC ROI 778
GLARC Project No. 11.126
EPA ID# WID980996367

Prepared For:

Mr. Mark Mather
Assured LLC/Pollution Risk Services
7870 E. Kemper Road, Suite 240
Cincinnati, OH 45249

United States Environmental Protection Agency Region 5
77 W. Jackson Blvd.
Chicago, IL 60604

Management Summary

In November 2011, Great Lakes Archaeological Research Center (GLARC) conducted an archaeological investigations of site 47SB0333 (Graham Brothers) for the Sheboygan River Legacy Act Dredging Project in the City of Sheboygan, Sheboygan County, Wisconsin. The investigation identified the location of the *Graham Brothers* shipwreck within the project's area of potential effect.

Archaeological investigations were conducted to partially fulfill requirements obtained from the execution of Section 106 of the National Historic Preservation Act of 1966 (P.L. 89-665) as amended and 36 CFR, Part 800, which serves to implement the Act. Investigations of the project areas were conducted in two stages. The first stage consisted of a comprehensive archival and literature review to identify the location of site 47SB0333, and to assess the possibility of the site remaining intact. The second stage of investigations consisted of the location and mapping of the shipwreck site.

Archaeological survey of site 47SB0333 identified the precise location of the shipwreck and determined that the shipwreck site remains largely intact. The hull of the ship is partially buried under sediment on the east bank of the Sheboygan River, while parts of the ship's futtocks, outer hull planking, rudder, and associated hardware extend out of the shore. The historic context of the *Graham Brothers* shipwreck as well as the site's overall integrity would likely justify the site's inclusion as eligible for listing on the National Register of Historic Places. In order to eliminate potential damage to the site it is recommended that proposed dredging activities avoid the shipwreck site. To facilitate this resolution a map of the site was created with a 10 foot buffer zone around the ship's remains. If the shipwreck cannot be avoided through project design, then it is recommended that a formal evaluation of 47SB0333 be conducted to determine if the site meets the criteria for listing on the National Register of Historic Places.

Table of Contents

Management Summary	2
Part I: Project Background	1
Introduction	1
Project Description and Area of Potential Effect	1
Part II: Results of Investigation	4
Archives and Literature Research	4
<i>Graham Brothers</i>	4
Field Survey	5
Site Description	5
Port Side Frame Description	5
Stern Section	9
Submerged Starboard Side	9
Discussion	9
Conclusions and Recommendations	11
Part III: Summary and Recommendations	12
References Cited	15
Bibliography of Report	16

List of Figures

Figure 1.1 Project location in Wisconsin	1
Figure 1.2 The project area and 47SB0333 shipwreck site	2
Figure 2.1 The authors measuring the beam of the <i>Graham Brothers</i> Schooner	4
Figure 2.2 K. Cullen measuring a rib from the <i>Graham Brothers</i> Schooner	4
Figure 2.3 GPS Boundary of Site 47SB033 with 10 foot buffer zone	6
Figure 2.4 <i>Graham Brothers</i> Shipwreck Site Plan.	7
Figure 2.5 Ship's futtocks.	9
Figure 2.6 Submerged timber and futtocks from the <i>Graham Brothers</i>	9
Figure 2.7 Remains of the <i>Graham Brothers</i> ' rudder.	10

Part I: Project Background

Introduction

In November 2011, Great Lakes Archaeological Research Center, Inc. (GLARC) conducted archaeological investigations of site 47SB0333 (Graham Brothers) for the Sheboygan River Legacy Act Dredging Project, located in Sheboygan County, Wisconsin (Figure 1.1). The study was designed to determine whether the *Graham Brothers* schooner shipwreck site was intact, and if so, to identify its location and assess its overall integrity. Methods included archival research and archaeological survey of the shipwreck site within the area of potential effect for the dredging project. The investigation resulted in the location of the *Graham Brothers*. The shipwreck was mapped with a GPS and a site plan was created. The site may be eligible for listing on the National Register of Historic Places, though additional evaluation is necessary to make a formal determination. As such it is suggested that dredging activities avoid the site area. Toward that end a ten foot buffer zone was established and mapped around the shipwreck site. If the shipwreck cannot be avoided through project design, then it is recommended that a formal evaluation of 47SB0333 be conducted to determine if the site meets the criteria for listing on the National Register of Historic Places. The project was conducted on behalf of the United States Environmental Protection Agency (EPA ID# WID980996367) and for Mark Mather of Assured LLC/Pollution Risk Services.

The study was conducted to partially fulfill responsibilities for identifying, recording, and managing cultural resources under the specifications of Section 106 of the National Historic Preservation Act of 1966 (P.L. 89-665) as amended and 36 CFR, Part 800, which serves to implement the Act. The methods and techniques used during the course of these investigations conform to the standards and guidelines set forth by the United States Secretary of Interior in *The Secretary of Interior's Standards and Guidelines for Archaeology and Historic Preservation* (48 FR 44716) and the *Guidelines for Public Archeology in Wisconsin, as Revised* (Wisconsin Archaeological Survey Guidelines Committee 1997). Supporting documentation, field notes, and other materials generated during the design and execution of this project are currently on file at Great Lakes Archaeological Research Center, located at 1408 North 5th Street in Milwaukee, Wisconsin.

Project Description and Area of Potential Effect

The Sheboygan River Legacy Act Dredging Project will dredge sediments from the Sheboygan River, beginning at the foot of New York Street and Kiwanis Park to the 8th Street Bridge (Figure 1.2). The area of potential effect for the project includes the entire riverine corridor between these termini. Archaeological field investigation for the project was limited to the immediate site boundaries of 47SB0333.

The *Graham Brothers* shipwreck is located in Township 15N Range 23E in the SW 1/4 of the SW 1/4 of Section 23, on the eastern bank of the Sheboygan River, directly west and downslope of Sheboygan Central High School (Figure 1.2).

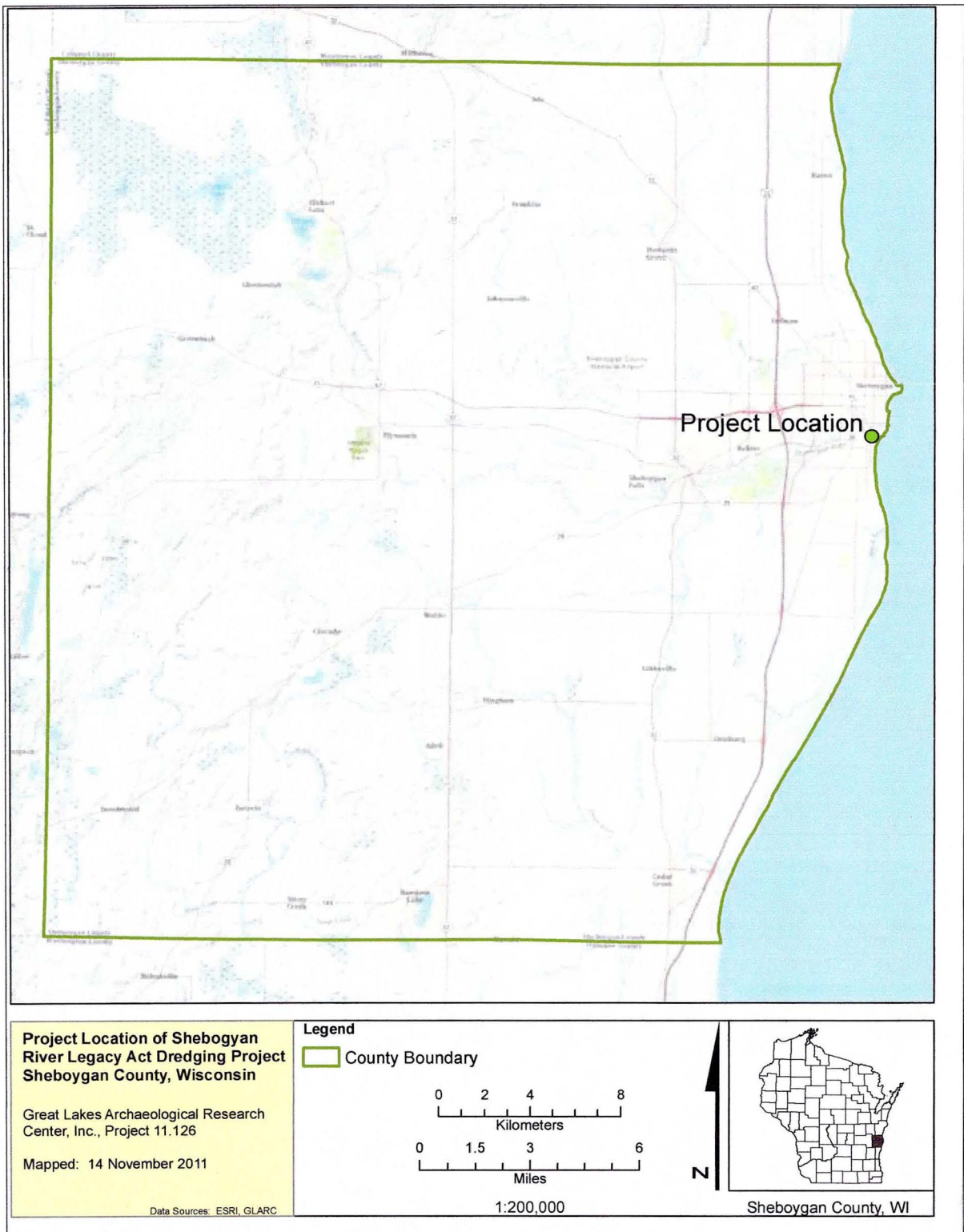

Figure 1.1 Project location in Wisconsin.



Figure 1.2 The project area and 47SB0333 shipwreck site.

Part II: Results of Investigation

Archives and Literature Research

Archival and literature research was conducted to determine the location and condition of the *Graham Brothers* shipwreck (47SB0333). Consulted sources include the Wisconsin Archaeological Site Inventory, maintained by the Wisconsin Historical Society, the Great Lakes Maritime Database, newspaper accounts, historic maps, and scholarly texts.

Graham Brothers

The *Graham Brothers* site (47SB0333) consists of the wreckage of a wooden two masted schooner abandoned in 1905 (DCA 1905:1) on the eastern shore of the Sheboygan River (Kelley 1956:1).

The *Graham Brothers* schooner (official number US85375), so named after the original owners, was constructed in Fort Howard, Wisconsin by S. Vaughn in 1874. The ship measured 81' in length, 20' on the beam, and was 7' deep. The gross tonnage was 82 with a net of 77. Ownership of the vessel changed hands several times. The ship was abandoned in 1905 on the eastern bank of the river (GLMD).

The Wisconsin Archaeological Site Inventory lists the site status of the wreck as unconfirmed, and an analysis of the locations of Wisconsin shipwrecks conducted by Maverden and Thomsen list the wreck as probable (2008:88), which they describe as:

...vessels that have not yet been located, but according to historic records occurred at a location that is specific to a harbor, shoal, reef, island, river mouth, landing etc., or at an approximate location according to mileage, direction, or landmark status (2008:6).

Photographic evidence from the Great Lakes Maritime Database and from Hirthe and Hirthe (1986:28, 74) indicate that the ship was abandoned on the lower eastern bank of the river, at the foot of a wooded bluff. Confirmation that the wreck site was still intact over fifty years after the ship was abandoned was provided by an article in the Sheboygan Press from 1956:

Skeletons of other ships now lying buried in the immediate area include the schooner Graham [Brothers], abandoned in the river in 1909 [sic] and still visible below Central High School..." (Kelley 1956:17).

The Sheboygan Press article establishes 1956 as the earliest possible date for the site to have been disturbed. The most likely source for site disturbance within the river is by dredging. Therefore, United States Army Corps' dredging records were consulted to assess whether the site area was dredged. According to these documents, in the area between the Pennsylvania Bridge and the 8th Street Bridge, only the western half of the river was ever dredged. The Corps' dredging program began in 1956. In the portion of the Sheboygan River near the *Graham Brothers* wreck, dredging work consisted of the channelization of only the western half of the river. It follows that if the ship were still in the location of its abandonment, a

supposition last confirmed in 1956, then it would be possible that the ship, or parts thereof, could still be located at the foot of Central High School.

Field Survey

A site visit conducted in November of 2011 confirmed that the *Graham Brothers* schooner was still located on the eastern bank of the Sheboygan River, directly below Central High School. The site remains unmolested by human activity, likely due to the inaccessible nature of the area. The wreck site is located at the foot of a steep and densely wooded river bluff. The foot of the bluff is heavily concealed by brush and a thick wall of live and fallen trees.

A second site visit was conducted in order to fix the location of the site via GPS (Figure 1) and to produce a site plan map (Figure 2). The majority of the wreck is located under water and/or under river sediments, so a scuba diver was employed to aid in mapping (ie. Cullen, author; Figure 2.3, Figure 2.4). GPS coordinates were captured using a MobileMapper 100 handheld GPS unit. GPS data was post processed using MobileMapper Office software. A plan map was drawn by securing a baseline across the long axis of the ship, and using trilateration at five meter intervals to plot spatial data (Figure 2.4). Approximate dimensions and depths of the submerged/buried parts of the shipwreck were delineated by probing the sediment with a measured rebar (Figure 2.3). Detailed photographs of every visible feature of the shipwreck were taken using a Canon D40. A site plan (Figure 2.2) and photograph log were created to add location information to the photographs.

Site Description

The remains of the two masted schooner *Graham Brothers* presently consist of at least 20 meters of extant timber and metal remains above the Sheboygan River water level (as of November 12th 2011). The verified remains of the entire shipwreck site (above and below water) is approximately 25 meters x 7 meters. Since its abandonment in 1905, the vessel has undergone substantial disarticulation, with the most of the superstructure no longer present; what remains is the last meter or two of the *Graham Brothers* carvel planked hull, likely including its keel and keelson timbers. The remaining architectural features that are visually apparent along the port side of the shipwreck (from shore), include: at least twenty sets of futtock's, (the ships frames [aka ribs]), at least two dozen square ship nails (pins), ten carvel type hull planks along the port stern, the ship's rudder post, and a portion of the rudder (Figure 2.4).

Port Side Frame Description

Each set of oak futtocks are double hung and nailed together with square pins to create a rigid frame, upon which the outer hull planking and inner ceiling planking is nailed to. Many of these square nails (pins) are scattered along the shoreline, having eroded from the former superstructure. Meanwhile, half of the noted frames contain the presence of at least one square nail still embedded in it. The average total diameter of the inner molded surface per frame is 20 centimeters. The average spacing per frame was 40 centimeters. The maximum height of these frames above the sediment surface is about 50 cm (frame A, refer to the site plan [Figure 2.2] for indicated features). However, several other frames have eroded to the shore's surface level (J, S, etc.) due to river ice damage over the past century (Figure 2.5).

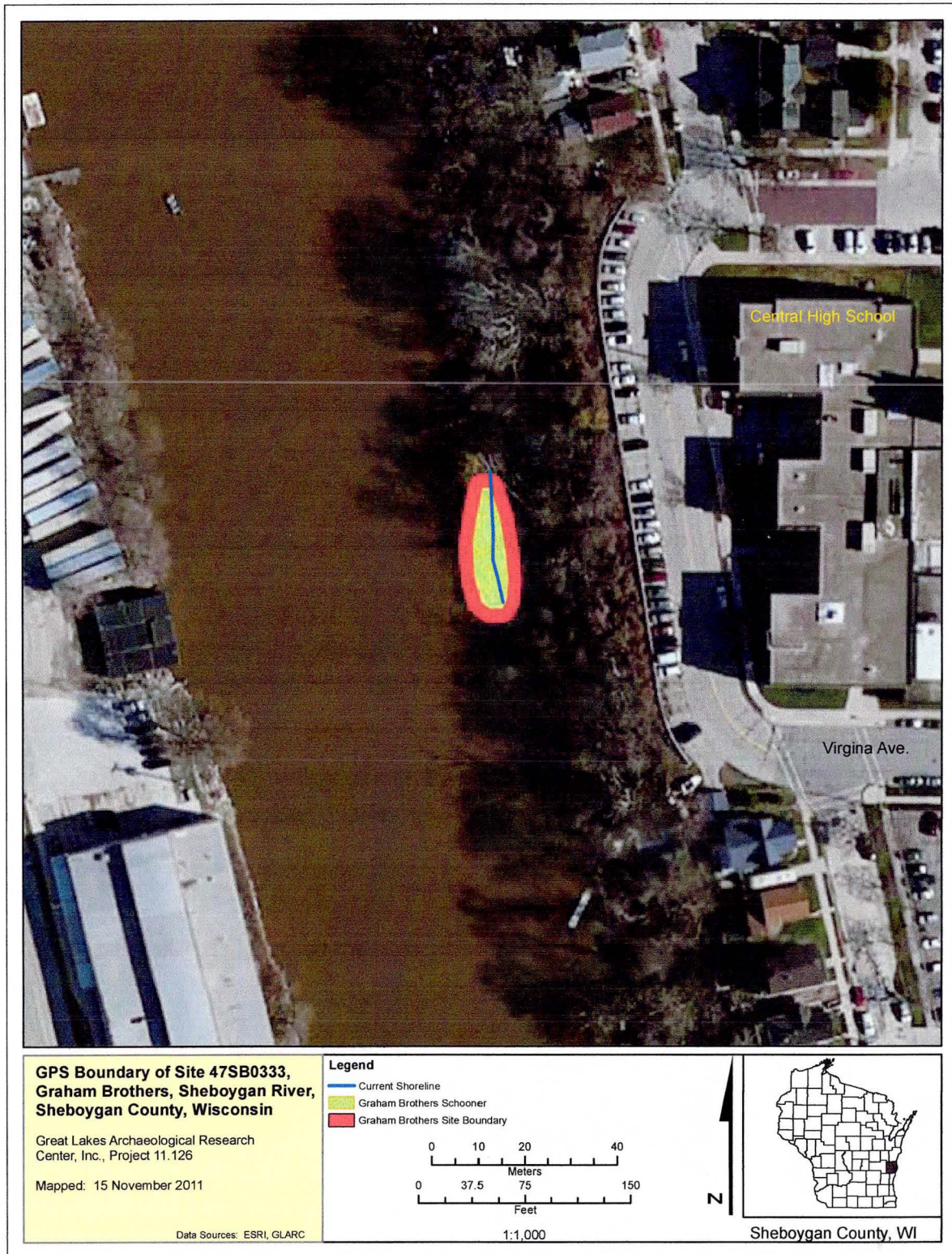

Figure 2.1 GPS Boundary of Site 47SB033 with 10 foot buffer zone.



Figure 2.3 The authors measuring the beam of the Graham Brothers Schooner.



Figure 2.4 K. Cullen measuring a rib from the Graham Brothers Schooner.

Located in shallow water at midship is a large rectangular timber with grooves and an iron bar embedded in it (Figure 2.6). It measures 360 x 27 x 7 cm. The timber could be part of the ship's gunnel (railing). It is oriented 358 degrees, roughly north/south. This timber formed the parallel axis for the survey baseline. One meter east of this architectural feature were two buried frames (M and N). Without excavation it is difficult to positively conclude that feature N is indeed a frame due to its small size (10 x 10 cm).

Stern Section

Very little remains above water of the stern section of the *Graham Brothers*. It was noted that the rudder post, though heavily eroded, is discernible and measures 18 cm fore/aft and 20cm starboard/port. If the rudder post is taken to be the midship then her bow is pointing due south. The remains of the oak framed rudder can be seen directly behind the rudder post. Presently it consists of three abutting sections (45 cm in diameter) fastened with a round drift pin (50 cm x 2 cm), with the head facing the rudder post (Figure 2.7). There is visible evidence of the lower stern decking 1 meter forward of the rudder post. Finally, at least seven outer hull planks are visible above water that are connected to the extant frames. The wood species of these planks were not verified, though they are likely oak as well. The extant planks are approximately 5 cm in thickness x 20 cm in diameter. The average length could not be ascertained as most of the planks are submerged in river sediment.

Submerged Starboard Side

It was noted that there is still a substantial degree of intact lower hull (bilge) present below the water line and, more importantly, buried in the sediment. This was confirmed using a measured rebar to probe into the sediment and delineate the presence or absence of wood beneath the sediment (Figure 2.3). It was noted that approximately one meter of overburden is covering much of the starboard section of shipwreck. Due to the poor visibility and presence of contaminants in the river, the submerged hull remains were delineated by feel. As a result, it was determined that there is a much greater degree of preservation underwater at an average depth of 1 to 1.5 meters below the surface. While these submerged remains were not inspected visually, it was clear that both the outer hull planking and inner ceiling planking over the starboard side frames remain relatively intact. Moving forward on the starboard side, it was noted that little remains of the *Graham Brothers* bow. What does remain appears to be flattened on the bottom of the river, likely "herring boned" from a century of degradation. There was no confirmation of a stem post, though its presence below the water or in the sediment is possible.

Discussion

The *Graham Brothers* shipwreck site consists primarily of the lower hull section of the 1874 schooner. The starboard section is better preserved than the portside, though it was the latter that allowed for more precise measurement of the ships construction. Without undergoing a more detailed survey, it cannot be determined as to what extent the shipwreck site extends beyond the observed dimensions. Moreover, without excavation of the hull, it cannot be determined to what degree the keel section and by association the mast steps remain intact. There is still a great deal that can be learned from this shipwreck in terms of construction methods, as well as the full scope of the submerged and buried features.

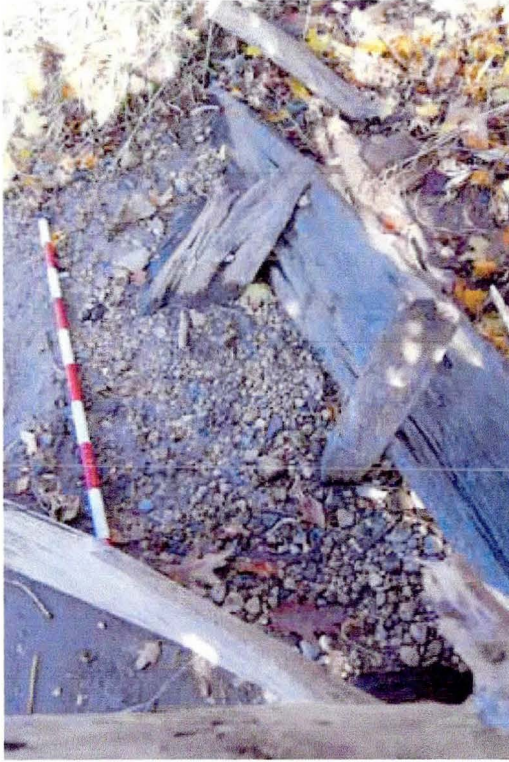

Figure 2.5 Right: Ship's futtocks (O and P from site plan [Figure 2.2]). Left: line of ship's futtocks protruding from shore.



Figure 2.6 Submerged timber (center, possible gunnel plank) and futtocks (lower left) from the Graham Brothers.



Figure 2.7 Remains of the Graham Brothers' rudder.

Conclusions and Recommendations

Site 47SB0333, the *Graham Brothers* schooner, was located embedded in the eastern shore of the Sheboygan River during archaeological investigations for the Sheboygan River Legacy Act Dredging Project. A plan map of the site was created, and GPS coordinates were collected in order to document the shipwreck's location.

The *Graham Brothers* schooner represents a vessel type particular in both spatial and temporal attributes. In terms of regional history, schooners built in the Great Lakes region between 1850 to 1900 represent a unique adaptation to the typical sea going vessel, with modifications constructed to deal with the hardships inherent in Great Lakes shipping (Karamanski 2000). It is likely that the *Graham Brothers* wreck site contains data that would prove useful for studies of late 19th century Great Lakes shipbuilding and commerce. As such, site 47SB0333 may be eligible for listing on the National Register of Historic Places, under criteria C and D of the National Historic Preservation Act of 1966 (P.L. 89-665) as amended, section 36 CFR Part 800, s 60.4.

It is recommended that ground disturbing activity associated with the Sheboygan River Legacy Act Dredging Project avoid the area of the *Graham Brothers* shipwreck (47SB0333). Toward that end the site was mapped both by hand and with a GPS unit. A ten foot buffer was added to the dimensions of the ship to account for possible submerged features of the shipwreck that were not discovered during survey work (Figure 2.1). It is recommended that all ground disturbing activity avoid site 47SB0333 and the ten foot buffer zone. If the shipwreck cannot be avoided through project design, then it is recommended that a formal evaluation of 47SB0333 be conducted to determine if the site meets the criteria for listing on the National Register of Historic Places.

Part III: Summary and Recommendations

In November of 2011, Great Lakes Archaeological Research Center (GLARC) conducted Phase I archaeological investigations for the Sheboygan River Legacy Act Dredging Project located in the City of Sheboygan, Sheboygan County, Wisconsin. The investigations were conducted within the area of potential effect for a dredge site and within the bounds of archaeological site 47SB0333, reported as a partially submerged shipwreck.

Archaeological investigations detailed in this document were conducted under the auspices of the United States Environmental Protection Agency. The archaeological investigations detailed in this document were carried out on behalf of Mark Mather of Assured LLC/Pollution risk Services and the US EPA to partially fulfill requirements obtaining from the execution of Section 106 of the National Historic Preservation Act of 1966 (P.L. 89-665) as amended and 36 CFR, Part 800, which serves to implement the Act. Investigations of the project areas were conducted in two stages. The first stage consisted of a comprehensive archival and literature review to identify the location and integrity of site 47BS0333. The second stage of investigations consisted of physically locating the site, mapping the shipwreck, and recording the GPS coordinates of the site's boundary.

The shipwreck was determined to possess integrity based on the presence of a buried hull along with the following visually apparent features along the port side of the shipwreck: at least twenty sets of futtock's, at least two dozen square ship nails, ten carvel type hull planks along the port stern, the ship's rudder post, and a portion of the rudder. The ship is embedded in the bank of the Sheboygan River, and is therefore property of the State of Wisconsin, under custody, control, and supervision of the Wisconsin Historical Society, pursuant to Section 6 (a3) (c) of the Abandoned Shipwreck Act of 1987. It is determined that site 47SB0333 may be eligible for listing on the National Register of Historic Places. It is recommended that all potential ground disturbing activities avoid the area of site 47SB0333, along with a buffer zone of 10 feet to account for possibly undiscovered buried features associated with the site. Site 47SB0333 is currently located within the area of potential effect for the Sheboygan River Legacy Act Dredging Project. If the shipwreck cannot be avoided through project design, then it is recommended that a formal evaluation of 47SB0333 be conducted to determine if the site meets the criteria for listing on the NRHP.

These results notwithstanding it should be noted that current conventional archaeological survey techniques are inadequate to determine the presence of deeply buried archaeological or paleontological deposits. Though the probability is unlikely, in the event that archaeological or paleontological materials are encountered during the course of the project, all construction in the area of the discovery should be halted.

If archaeological or paleontological materials are encountered immediate consultation to insure compliance with (1) 36 CFR 800.11, The Regulations of the Advisory council on Historic Preservation Governing the 106 Process; or (2) S. 44.40, Wis. Stats, may be obtained by contacting:

The Compliance Section
Historic Preservation Division
State Historical Society of Wisconsin
Phone (608) 262-2970

If human remains are encountered immediate consultation to insure compliance with S. 157.70, Wis. Stats may be obtained by contacting:

The Burial Sites Preservation Office
Historic Preservation Division
State Historical Society of Wisconsin
(800) 342-7834

References Cited

Great Lakes Maritime Database (GLMD)

2011 Graham Brothers; 1874; Schooner; US85375 (60759.60775). http://quod.lib.umich.edu/tb/nms1ic?type=boolean;view=thumbnail;rgn1=original_owner;q1=Graham%2520Bros. Accessed 11/15/2011.

Hirthe W.M. and M.K. Hirthe

1986 *Schooner Days in Door County*. Voyageur Press, Minneapolis, Minnesota.

Karamanski, T.J.

2000 *Schooner Passage: Sailing Ships and the Lake Michigan Frontier*. Wayne State University Press, Detroit.

Kelley, C.E.

1956 Skeletons of Sunken Ships are Still Visible on Beach. In, *The Sheboygan Press*, 12/1/1956:17.

Meverden, K.N. and T.L. Thomsen

2008 *Wisconsin's Historic Shipwrecks: an Overview and Analysis of Locations for a State/Federal Partnership with the National Marine Sanctuary Program*. State archaeology and Maritime Preservation Program Technical Report Series #08-003. Wisconsin Historical Society, Madison.

National Park Service

1983 *The Secretary of the Interior's Standards and Guidelines for Archaeology and Historic Preservation*. National Park Service, Washington, DC

Unknown (DCA)

1905 The passing of the Schooner. In, *The Door County Advocate*, 8/5/1905:1.

Wisconsin Archaeological Survey Guidelines Committee

1997 *Guidelines for Public Archaeology in Wisconsin, as Revised*. Wisconsin Archaeological Survey, Madison.

Appendix

BIBLIOGRAPHY OF ARCHAEOLOGICAL REPORT FORM

WHS/SHSW # _____ COUNTY: Sheboygan

AUTHORS: Richard H. Kubicek and Kevin M. Cullen

REPORT TITLE: An Archaeological Investigation of the Graham Brothers Schooner Shipwreck (47SB0333) in the Sheboygan River, City of Sheboygan, Wisconsin

DATE OF REPORT (MONTH AND YEAR): November 2011

SERIES/NUMBER: ROI 778

PLACE OF PUBLICATION: Great Lakes Archaeological Research Center, Milwaukee, WI

LOCATIONAL INFORMATION [LEGAL DESCRIPTION OF SURVEY AREA (T-R-S)]
Township 15N Range 23E in the SW 1/4 of the SW 1/4 of Section 23

U.S.G.S. QUAD MAP(S): Sheboygan South

SITE(S) INVESTIGATED: 47SB0333

ACRES INVESTIGATED: 0.036

AGENCY # EPA ID# WID980996367

INVESTIGATION TECHNIQUES COMPLETED (Check all that apply.)

- | | | |
|--|--|---|
| <input type="checkbox"/> Avocational Survey | <input type="checkbox"/> Chance Encounter | <input type="checkbox"/> Controlled Surface Collection |
| <input type="checkbox"/> Faunal Analysis | <input type="checkbox"/> Floral Analysis | <input type="checkbox"/> Geomorphology |
| <input checked="" type="checkbox"/> Historical Research | <input type="checkbox"/> Interview/Informant | <input checked="" type="checkbox"/> Land Use History |
| <input checked="" type="checkbox"/> Literature Background Research | <input type="checkbox"/> Major Excavation | <input type="checkbox"/> Mechanical Stripping |
| <input type="checkbox"/> Monitoring | <input type="checkbox"/> Osteological Analysis | <input type="checkbox"/> Phase I-Surface Survey |
| <input type="checkbox"/> Phase II | <input type="checkbox"/> Phase II-Corridor Only | <input type="checkbox"/> Phase III |
| <input type="checkbox"/> Phase III-Corridor Only | <input checked="" type="checkbox"/> Records/Background | <input type="checkbox"/> Records/Background (Pred. Model) |
| <input type="checkbox"/> Remote Sensing | <input type="checkbox"/> Shovel Testing/Probing (Inten) | <input type="checkbox"/> Soil Core |
| <input type="checkbox"/> Surface Survey (Intensive) | <input type="checkbox"/> Test Excavation | <input type="checkbox"/> Traditional Knowledge |
| <input type="checkbox"/> Vandalism | <input checked="" type="checkbox"/> Walk Over (Reconnaissance) | <input type="checkbox"/> Unknown |
| <input checked="" type="checkbox"/> Other: <u>Underwater probing</u> | | |

ABSTRACT: Included in report Written in space below

In November 2011 Great Lakes Archaeological Research Center, Inc. (GLARC) conducted an archaeological investigation of site 47SB0333 (Graham Brothers) for the Sheboygan River Legacy Act Dredging Project, located in Sheboygan County, Wisconsin. The study was designed to determine whether the *Graham Brothers*, a late 19th century two masted Great Lakes Schooner abandoned on the shores of the Sheboygan River in 1905, was intact, and if so, to identify its location. Methods included archival research and archaeological survey of the shipwreck site within the area of potential effect for the dredging project. The investigation resulted in the location of the *Graham Brothers*. The shipwreck was mapped with a GPS and a site plan was created.



December 23, 2011

From: Mark Mather, 
Pollution Risk Services, LLC

To: Wisconsin Historical Society, Division of Historical Preservation

Memorandum Regarding

SHPO Information Submission

SHPO Project WHS 11- 0987

Sheboygan River CERCLA and Sheboygan River Legacy Act Dredging Projects

On September 27, 2011, your office returned the previously submitted, "REQUEST FOR SHPO COMMENT AND CONSULTATION ON A FEDERAL UNDERTAKING" as copied and attached to this form. With this Memorandum, please find the attached required report.

- **An Archaeological Investigation of the *Graham Brothers* Schooner Shipwreck (47SB0333) in the Sheboygan River, City of Sheboygan, Wisconsin**

Our follow up submission, attached, has indicated that *No historic properties will be affected.* Please note that the Dredging Projects will have identified the historic boundaries identified through quality control (GPS positioning and visual identification) and no dredging will be performed within the identified historic location.

Please be aware that a significant amount of energy is focused on the Sheboygan River clean up, and US EPA may have additional REQUESTS FOR SHPO COMMENT for other potential work areas.

REQUEST FOR SHPO COMMENT AND CONSULTATION ON A FEDERAL UNDERTAKING

Submit one copy with each undertaking for which our comment is requested. Please print or type. Return to:

Wisconsin Historical Society, Division of Historic Preservation, Office of Preservation Planning, 816 State Street, Madison, WI 53706

Please Check All Boxes and Include All of the Following Information, as Applicable:

I. GENERAL INFORMATION

- This is a new submittal.
- This is supplemental information relating to Case #: WHS11-0987 and title: Sheboygan River
- This project is being undertaken pursuant to the terms and conditions of a programmatic or other interagency agreement. The title of the agreement is _____

- a. Federal Agency Jurisdiction (Agency providing funds, assistance, license, permit): USEPA
- b. Federal Agency Contact Person: Heather Williams Phone: 312-886-5993
- c. Project Contact Person: Mark Mather Phone: 513-387-2778
- d. Return Address: 7870 E Kemper Road, Suite 240, Cincinnati, Ohio 45249 Zip Code: 45249
- e. Email Address: mmather@assuredllc.com
- f. Project Name: Sheboygan CERCLA Project and Sheboygan River Legacy Act Dredging Project
- g. Project Street Address: N/A
- h. County: Sheboygan City: Sheboygan Zip Code: 53081
- i. Project Location: Township 15N, Range 23 E (E/W (circle one)), Section 22 & 23, Quarter Sections NE . SW
- j. Project Narrative Description—Attach Information as Necessary.
- k. Area of Potential Effect (APE). Attach Copy of U.S.G.S. 7.5 Minute Topographic Quadrangle Showing APE.

II. IDENTIFICATION OF HISTORIC PROPERTIES

- Historic Properties are located within the project APE per 36 CFR 800.4. Attach supporting materials.
- Historic Properties are not located within the project APE per 36 CFR 800.4. Attach supporting materials.

III. FINDINGS

- No historic properties will be affected (i.e., none is present or there are historic properties present but the project will have no effect upon them). Attach necessary documentation, as described at 36 CFR 800.11.
- The proposed undertaking will have no adverse effect on one or more historic properties located within the project APE under 36 CFR 800.5. Attach necessary documentation, as described at 36 CFR 800.11.
- The proposed undertaking will result in an adverse effect to one or more historic properties and the applicant, or other federally authorized representative, will consult with the SHPO and other consulting parties to resolve the adverse effect per 36 CFR 800.6. Attach necessary documentation, as described at 36 CFR 800.11, with a proposed plan to resolve adverse effect(s).

Authorized Signature: *Mark Mather* Date: 12/23/2011
 Type or print name: Mark Mather

IV. STATE HISTORIC PRESERVATION OFFICE COMMENTS

- Agree with the finding in section III above.
- Object to the finding for reasons indicated in attached letter.
- Cannot review until information is sent as follows: _____

Authorized Signature: _____ Date: _____



7870 E Kemper Road, Suite 240
Cincinnati, Ohio 45249
Phone: 513-489-2793 Fax: 513-489-2794

February 3, 2012

Sherman J. Banker
Wisconsin State Historical Society
Historic Preservation
816 State Street
Madison, WI 53706-1482

**REGARDING: SHPO Project: WHS11-0987
Supplemental Information Submission
Sheboygan River CERCLA and Sheboygan River Legacy Dredging Projects**

Dear Mr. Banker:

Following up on our January 10 and February 2, 2012, conversations regarding the Sheboygan dredging projects and the *Graham Brothers Schooner*, we were asked to provide detail to mitigate the risk of disturbing the Historical location. This letter supplements the SHPO submission which sets or recommends that no sediment will be removed or any other disturbance will occur within 10' of the identified Historical Area. The following procedures will be incorporated in our work plans:

Dredging Quality Procedures to identify and maintain protection of the *Graham Brothers Schooner* Shipwreck in the Sheboygan River.

- Inform all dredging personnel that there is a Historical location within the river and that a 10' work offset boundary is in place, as recommended in the Archaeological Investigation No. 778.
- Dredge sediment near the Historical area with GPS guided machinery with a computer monitor identifying the offset locations for the dredge operator.
- Place physical markers in the river at the offset boundaries before any sediment removal work is performed within 500 feet of the Historical location.
- Monitor all sediment removal activity within 40 feet of the Historical area with a Quality technician. The technician will have sight lines of the dredge operator and the physical offset markers.

If you have any questions feel free to contact me by phone at 513-387-2778 or via e-mail at mmather@assuredllc.com.

Warmest regards,

Mark Mather
President

Appendix D
Sign-off Acknowledgement Form

SIGN-OFF ACKNOWLEDGMENT FORM

Please Print:

NAME:

EMPLOYER:

JOB SITE: Sheboygan River and Harbor Superfund Site

I have attended and understood the mandatory initiation session for the above referenced job site where I read or was provided with an explanation of the Environmental Protection Plan (EPP).

This program referenced the following topics:

Signature

Date

Dredge Plan
Sheboygan River and Harbor Superfund Site
Sheboygan County, Wisconsin

March 2011
Revised February 2012

Prepared By
Pollution Risk Services, LLC

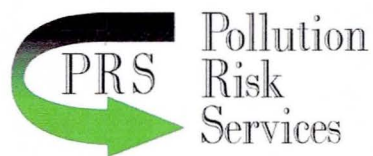

DREDGE PLAN

1.0	INTRODUCTION	2
2.0	RIVER DREDGE PROGRESSION	3
3.0	EQUIPMENT	4
4.0	MEANS AND METHODS	6
5.0	BEST MANAGEMENT PRACTICES.....	9
6.0	QUALITY ASSURANCE/QUALITY CONTROL	10
7.0	FUELING.....	13
8.0	DECONTAMINATION	14

Figures

Figure 1 River Dredge Progression

Appendices

Appendix A Schedule
Appendix B Polymer MSDS
Appendix C Dewatering Area Layout
Appendix D Wastewater Treatment Plant P&ID

1.0 INTRODUCTION

The Dredge Plan (DP) is an appendix to the Remedial Action Work Plan (RAWP). It has been prepared to document dredging activities to be implemented as part of Sediment Removal actions required at the Sheboygan River and Harbor Superfund Site, Sheboygan County, Wisconsin. Remedial activities are required to be implemented as set forth in the Record of Decision (ROD), Consent Decree (CD), and Lower River Statement of Work (LRSOW).

The Removal Action will consist of dredging sediment in the Lower River and Inner Harbor; furnishing and installing a cover if post-dredge verification sampling indicates a mitigating factor; and dredge slurry operation.

2.0 RIVER DREDGE PROGRESSION

Dredge sequencing will be conducted as provided in Figure 1 and the Schedule, Appendix A. The Schedule may be modified from time to time with the Revision Date identified and the modified schedule submitted and approved by the USEPA.

The Schedule is discussed as a specific topic during the each weekly progress meetings. Any Schedule modification discussed during the progress meetings will be updated and made part of the Weekly Progress Meetings. Schedule updates and modifications in the weekly progress meetings *will be considered approved* unless USEPA sends specific instruction that the schedule is not approved as part of the Weekly Progress Meetings.

3.0 EQUIPMENT

Primary Dredging (Downstream of 14th Street Bridge)

Below list the basic equipment information.

- The Primary Dredge will be a 10” cutterhead (hydraulic) dredge with spuds and anchors.
 - The dredge will allow free movement using spuds that hold the dredge in place as the cutterhead swings in an arc pattern.
 - Depending on thickness of sediment and area of the grid-prism, several movements and cuts will be made to remove the sediment to the defined limits.
 - The Dredge will be equipped with electronic GPS positioning and control hardware-software. The electronics are discussed below in Section 6.
- Two 10” slurry booster pumps with 10-12” HDPE slurry water pipe.
- One 16 foot Jon boat with a 150 gallon diesel double-wall fuel tank secured in the hull. The fuel boat dispenses diesel to the dredge equipment using an electric pump powered with a 12-Volt battery.
- One 550 gallon diesel double-wall fuel tank powered with gasoline pump for fuel transfer to 150-gallon double-wall fuel tank on boat located at the City of Sheboygan granted access point at the 14th Street boat ramp outside flood zone.
- Support equipment
 - One outboard-powered 20 foot pontoon crew/survey boat,
 - Equipped with single-beam sonar for surveying.
 - Two outboard-powered aluminum Jon boats used to convey personnel to the dredge, booster pumps, and assist in positioning the slurry pipe.
 - One twin screw work boat used to position dredge and booster pumps.
 - One outboard-powered steel maintenance boats used to position the slurry pipe, and convey personnel to the dredge.

Secondary Dredging (Upstream of 14th Street Bridge)

Below list the basic equipment information.

- The Secondary Dredge will be a barge equipped with an excavator which will mechanically remove sediment and load a second sediment barge or sediment scow. The final determination of the equipment will be determined 60 days prior to removal and submitted to the agencies for approval.
 - The barge will allow free movement using spuds that hold the barge in place as the excavation takes place.
 - Depending on thickness of sediment and area of the grid-prism, several movements and cuts will be made to remove the sediment to the defined limits.
 - The mechanical Dredge will be equipped with electronic GPS positioning and control hardware-software. The electronics are discussed below in Section 6.
- Support and fuel equipment will be the same as the Primary dredge operations.

Dredge Slurry Operations

Below list the basic equipment information.

- Two 2,000 gallon per minute (gpm) primary diesel pump used to convey carriage water through the WWTP.

- One 1,500 gpm diesel pump used for backwashing the granulated activated carbon filtration vessels.
- Four 1,000 gpm dual media filtration vessels.
- Four 1,000 gpm granulated activated carbon filtration vessels.
- One 22,000 gallon frac tank used as effluent storage for backwashing.
- One 550 gallon diesel double-wall fuel tank powered with gasoline pump located at the dewatering area outside flood zone.
- P&ID attached in Appendix D

Sediment Cover

Below list the basic equipment information. A detailed cover placement schedule and design will be defined in the Cover Placement Plan submitted by June 30, 2012 approximately 90 days after mobilization/start-up.

- Sand/aggregate cover placement will use an excavator on a barge working platform.
- Support and fuel equipment will be the same as dredging operations.

4.0 MEANS AND METHODS

Primary Dredging (Downstream of 14th Street Bridge)

The Primary Dredge will be a 10-inch hydraulic cutter head dredge, described above. Sediment will be removed, generally, in two “passes” the first to remove the bulk material at elevation and the second pass used to refine the “neat line” or “design surface”. To begin dredging, the operator will slowly lower the ladder until the cutterhead is approximately 1’ above the top of sediment. The operator will then engage the hydraulic pump, slowly swinging and lowering the ladder, removing sediment encountered within the dredge arc pass.

As necessary, the operator will re-position or advance the dredge by lifting then re-setting the front anchors while re-positioning the aft spud. The advancing will be repeated until Design northing, easting and elevation planes or “X, Y, and Z planes” is reached. The removal locations (X, Y, and Z planes) provided in Figure 1 will be downloaded into the dredge software programs (i.e. DredgePack). The dredge hardware/software will be used to provide a visual for the operator (i.e. change color on the screen) when the sediment is removed to the Design “Z plane”. Sediment removal will be confirmed with bathymetry measurements. The Quality Team will perform the bathymetric measurements and post-processing of data. Further discussion of hardware/software can be found in Section 6, below. TSCA sediment will be established in-situ, using the pre-design and pre-dredge sampling data. TSCA sediment will be segregated from non-TSCA sediment by flushing the dredge slurry line with river water before and after dredge removal.

Debris may be encountered during sediment removal. Debris will be removed only from locations requiring dredging. Debris will be size reduced, placed in the hull of the work boat for containment, and taken to the dewatering pad for future disposal. At all times, debris with contaminated material adhered will be contained to prevent spillage during transport to the dewatering pad.

To protect the bank of the river from erosion and cave-in, sediment removal will begin from an lateral offset approximately two (2) feet away from the toe of slope of the bank, i.e. where water meets shoreline or any bank stabilization structure (i.e. rip rap/crushed concrete). In addition, a lateral setback of five (5) feet will be established to protect any bridge or boat slip support structure.

Booster pumps will be maintained at specific locations to provide energy to transport slurry. The additional energy infused to the dredge slurry is critical to enable the process to maintain velocities that allow for sediment transport. To ensure productivity is maintained, each booster pump will be staffed with operators to monitor and match dredge/booster engine output with line pressures.

Secondary Dredging (Upstream of 14th Street Bridge)

An excavator on a working barge platform will be used. Excavated sediment will be fed to a hopper barge or directly to an off road truck for transport to the dewatering area located at 415 Cleveland Street in Sheboygan Falls. See Figure 1 and narrative of the Sediment Management

Plan for details and operation of this dewatering area. An alternative method will be to pump the sediment from a scow via HDPE pipeline to geotextile tubes located on the dewatering pad at 2025 Maryland Avenue. The final determination of the process will be determined 60 days prior to removal and submitted to the agencies for approval. Sediment will be removed, generally, in 1-foot incremental "passes". The operator will then engage the sediment, slowly lowering the bucket, removing sediment encountered within the reach of the excavator.

If and as necessary, the operator will re-position or advance the excavator by the reach on the boom or by lifting the spuds on the platform barge and pushing with the work boat. The advancing will be repeated until Design northing, easting and elevation planes or "X, Y, and Z planes" is reached. The removal locations (X, Y, and Z planes) provided in the Design, Appendix E and F will be either downloaded into a GPS controlled system that identifies position to the dredge operator, or through physical markers (stakes or buoys) placed in the sediment. If using GPS dredge hardware/software, a computer monitor will be provide a visual for the operator (i.e. change color on the screen) when the sediment is removed to the Design "Z plane". Sediment removal will be confirmed with bathymetry measurements. The Quality Team will perform the bathymetric measurements and post-processing of data. Further discussion of hardware/software can be found in Section 6, below. TSCA sediment will be established in-situ, using the pre-design and pre-dredge sampling data. TSCA sediment will be segregated from non-TSCA sediment.

To protect the bank of the river from erosion and cave-in, sediment removal will begin from an lateral offset approximately two (2) feet away from the toe of slope of the bank, i.e. where water meets shoreline or any bank stabilization structure (i.e. rip rap/crushed concrete). In addition, a lateral setback of five (5) feet will be established to protect any bridge or boat slip support structure.

Sediment Cover

Below is a general discussion of cover placement schedule and design. A detailed cover placement schedule and design will be defined in the Cover Placement Plan submitted by June 30, 2012 approximately 90 days after mobilization/start-up.

Sand/Aggregate Cover

For the sand/aggregate cover layer placement, an excavator on a working barge platform will be used. Sand/aggregate will be fed to the excavator with a hopper barge. Sand/aggregate will be delivered at the boat ramp east of 14th Street by unloading sand/aggregate onto the barge from haul trucks. This location was chosen because of the logistical capabilities, adequate draft, and is identified as a non-contaminated area. Sand/aggregate will be provided from a local sand and gravel pit that can accommodate the required material specifications.

For the placement of cover, the grids identified to receive cover will be downloaded in the computer in the dredge. The grids will be displayed on the computer in the cab of the dredge to identify the lateral limits. Based on the size of the area and thickness of material, the known amount of cover material needed (cubic yards) can be determined with the known ton to cubic yard conversion. To spread the sand/aggregate layer evenly, the bucket will be lowered just below the water surface. The operator will swing the bucket throughout the grid until the defined limits of the cover are reached (e.g. in the X, Y, and Z planes). The dredge hardware/software

will be to provide a visual for the operator. Cover will find its own repose angle based on the dredge cuts and minimum required thickness. Cover thickness will be confirmed with bathymetry measurements.

Positioning the barge to start the cover will be done in a manner to prevent the spuds of the dredge from settling into the recently placed layer. All work will begin at the shoreline and work to the center of the river for larger grids-prisms or will begin upstream and work downstream in smaller grids-prisms.

Dredge Slurry Operations

Sediment slurry from the dredge will be conveyed via a 10-12" SDR 17 HDPE pipe line to identified TSCA and non-TSCA geo-textile tubes on the de-watering pad. The berm around the perimeter of the de-watering pad will provide the necessary run-on and run-off control.

A common header will feed branch hoses to the array of geo-textile tubes. Each branch line will be equipped with shut off plug to allow isolation of any geo-textile tube. An air gap will be installed at the end of the manifold to relieve the pressure when changing hoses.

The dewatering process will increase the solids content of the slurry by forcing the slurry through geo-textile tubes allowing the water to carriage flow out while retaining the solids and bulk of any PCBs. Flocculent will be a liquid polymer (AQ 200) provided by Aquamark. The Material Safety Data Sheet (MSDS) is provided in Appendix B. This chemistry provided positive results in the treatment of carriage water in 2011. The amount of polymer added to the slurry will be controlled by monitoring the density of the slurry and adjusting the dosage as different slurry characteristics are encountered. The polymer will be added to the slurry pipe prior to entering the geo-textile tubes. Because of the de-watering pad size, geo-textile tubes will be "changed out" 3 to 6 times (applied in a single layer) to hold the requirements of the design volume. By "changed out", the Design means the process of laying down a geo-textile tube, filling the tube with sediment, allowing for de-watering, opening the geo-textile tube and loading the sediment and used geo-textile tube into trucks, disposing the sediment and used geo-textile tube at the appropriate landfill, and re-laying down a new geo-textile tube for the next volume of sediment. Non-TSCA geotextile tubes may be stacked only to maintain continuous dredge operation. Appendix C provides the as-built drawing for the dewatering area.

Appendix D provides the P&ID for the WWTP. This treatment train provided positive results in the treatment of carriage water in 2011. Two 2,000 gallon per minute diesel pump will convey carriage water to the Wastewater Treatment Plant (WWTP). The pumps will be connected to the WWTP in accordance with the manufacturer's requirements and specifications. The speed of the pumps will be adjusted to sync with the dredge operation during the first week of operation to avoid excessive starting/stopping.

5.0 BEST MANAGEMENT PRACTICES

Primary Dredging (Downstream of 14th Street Bridge)

To reduce the likelihood of water quality impacts and minimize the migration of contaminated sediments beyond project limits, the following Best Management Practices (BMPs) will be utilized during dredging:

- Remove sediment deposits consistent with the Schedule, Appendix A
- Reducing cutterhead rotation speed
- Reducing swing speed of cutterhead
- Reducing or eliminating cut face undercutting by using a maximum lift thickness of 75% of the cutterhead diameter. This will be controlled by the operator who has information displayed on the screen in the cab.
- Turn pump off after cutter head during shutdown and vice versa during start-up

Secondary Dredging (Upstream of 14th Street Bridge)

To reduce the likelihood of water quality impacts and minimize the migration of contaminated sediments beyond project limits, the following Best Management Practices (BMPs) will be utilized during dredging:

- Install silt/bubble curtain to minimize downstream re-suspension
- Areas will not be dragged

Sediment Cover

To reduce the likelihood of water quality impacts and minimize the migration of contaminated sediments beyond project limits, the following Best Management Practices (BMPs) will be utilized during sediment cover placement:

- Place cover downstream to upstream (e.g. small grids-prisms) or shoreline to center of river (e.g. larger grids-prisms)
- Control release of cover material to minimize suspension
- Spuds will not penetrate areas previously covered
- Areas will not be dragged to even out over-placements
- Cover on slopes will be placed from toe of the slope up towards the crest

Dredge Slurry Operations

To reduce the likelihood of water quality impacts and minimize the migration of contaminated sediments beyond project limits, the following Best Management Practices (BMPs) will be utilized during dredge slurry operations:

- Backwashing dual-media filtration vessels
- Backwashing granulated activated carbon vessels

6.0 QUALITY ASSURANCE/QUALITY CONTROL

Primary and Secondary Dredging

Hardware/Software

Dredge equipment will utilize a dual GPS antenna system to provide the dredge heading and cutterhead/bucket position.

Because the point of interest on the dredge is not always the reference point, additional instrumentation will be added to the dredge to calculate the point of interest. These are as follows:

- Rotary encoder to detect the swing angle
- Inclinometer to measure the ladder angle relative to the vertical

The coordinates of the point of interest, as calculated using the GPS system, and angle information are sent to survey software by HYPACK® known as DREDGEPACK®. DREDGEPACK® serves two purposes:

- Provides a continuous log of coordinates and elevations for the point of interest.
- Provides tools to help the operator accurately position dredge at required coordinates and elevation. The system accepts and displays on a monitor located in the cab of the dredge existing information in plan view.

The Design cuts "X, Y, and Z planes are loaded into the software to provide the operator with a visual location of sediment to remove in plan view. As sediment is removed, the software updates the plan view to provide a visual image to the dredge operator that show where design cuts have been made and where design cuts have not been made or missed using a color indicator (e.g. red to green).

Turbidity

Visual turbidity monitoring will be performed continuously during dredging. Turbidity measurements will be performed every two hours at locations 150-feet upstream and 500-feet downstream from the dredge. Additional detail is provided in the Water Management Plan, Section 2.4.

Bathymetric Survey

The pre-dredge bathymetric survey will be used as the top layer or existing layer of sediment. After dredging is complete, bathymetric surveys will be conducted with a pontoon boat equipped with a 12-channel precision DGPS receiver, beacon receiver, digital 200 kHz single beam depth sounder, and computer system purchased from Specialty Devices. This post-dredge bathymetric survey will be used as the record document, verifying completion of work in an area.

Some areas of the river will have insufficient draft for the electronic measurement boat. In these areas and those shielded from satellite positioning, reference points and manual bathymetry measurements will be added to the data collected. Manual measurements will be collected as described in SOP #4 of the Verification Sampling Plan. This methodology was approved by the USEPA in letter dated 12/12/11.

Post-dredge Verification Sampling

Post-dredge verification samples will be collected using a Vibrating Core Sampler and analyzed for PCB concentration. Sampling will be conducted after bathymetric survey has indicated that dredging has reached the design surface. The core samples will be collected to a depth of two feet or refusal, whichever comes first. The core samples will be collected from the bottom (located at the grid or sub-grid) and from the midpoint of the slope on each edge of the grid or sub-grid abutted to a non-dredged grid or sub-grid. Bottom cores will be analyzed at the 0-6" and 0-2' intervals by splitting the core in half. The 0-6" interval from one half of the core will be homogenized for analysis and the 0-2' interval from the second half of the core will be homogenized for analysis. Edge cores will be analyzed at the 0-2' interval by homogenizing the entire core. The results will be evaluated with the *Mitigation Plan, Appendix A – Decision Tree* to determine if additional sediment removal is required.

SWAC Determination Sampling

In grids in the Lower River and Inner Harbor Between Pennsylvania Avenue and 8th Street Bridges (IHBB) 500 feet downstream from last dredge grid (generally grids 102/103), post-dredge or post-remediation sediment surface (0-6") will be sampled with a Ponar Sampler and analyzed for PCB concentration. Post-dredge SWAC sampling will be performed on both sides of a river reach area after dredge operations have progressed more than 200 feet down river of the sampling areas. Post-dredged sediment surface will have samples collected at a rate of six (6) grabs per 8,100 square foot grid with a Petite Ponar Dredge. The grab samples will be composited. The grab samples will be collected from the center of six (6) equal sub-grids established within the 8,100 square foot grid. The results will be evaluated with the *Mitigation Plan, Appendix A – Decision Tree* to determine if cover is required.

In grids in the Inner Harbor 500 feet downstream from last dredge grid (generally grids 102/103) to the mouth, post-dredge or post-remediation sediment surface (0-6") will be sampled with a Ponar Sampler and analyzed for PCB concentration. Sampling will be conducted immediately following completion of dredging between the Pennsylvania Avenue and 8th Street Bridges (generally grids 102/103). Post-dredged sediment surface will have samples collected at a rate of one (1) grab per 8,100 square foot grid with a Petite Ponar Dredge. The grab samples will be generally collected from the same location as the Pre-design Investigation.

Sediment Cover

Hardware/Software

Cover equipment will utilize the same hardware/software described above.

Cover areas are loaded into the software to provide the operator with a visual in plan view. The system updates the plan view to provide a visual image to the dredge operator that show where cover placement is complete and where cover placement is not complete using a color indicator (e.g. red to green).

Turbidity

Visual turbidity monitoring will be performed continuously during cover placement. Turbidity

measurements will be performed every two hours at locations 150-feet upstream and 500-feet downstream from the dredge.

Bathymetric Survey

The post-dredge data collected will be used as the top layer or existing layer of sediment. Weekly bathymetric surveys will be conducted with a pontoon boat equipped with a 12-channel precision DGPS receiver, beacon receiver, digital 200 kHz depth sounder, and computer system. This post-cover bathymetric survey will be used as the record document, verifying completion of work in an area. Again, in some areas, manual water bathymetry measurements may augment the electronic measurements. This is described above in the Primary and Secondary Dredging section.

Dredge Slurry Operations

Effluent turbidity (correlated to TSS) measurements will be collected every hour to provide real-time evaluation of the WWTP and influent and effluent sampling will be performed per the requirements of the Wisconsin Pollution Discharge Elimination System (WPDES) permit provide in Appendix A of the Water Management Plan.

7.0 FUELING

Fuel transfers will be performed in accordance with U.S. Coast Guard oil transfer procedures. Diesel fuel is stored in 150 and 550 gallon double-wall fuel tanks. All fuel transfer hoses will be inspected, tested, and maintained in accordance with U.S. Coast Guard requirements. Spill procedures will be in accordance with the *Contingency Plan* and *Environmental Protection Plan*.

8.0 DECONTAMINATION

Equipment decontamination will include the following procedures:

- The equipment will be thoroughly inspected, pressure washed, and scraped clean prior to winterization/de-mobilization.
- All latent material will be contained, loaded, and hauled to the designated landfill for proper disposal.

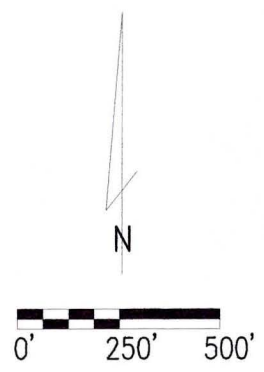
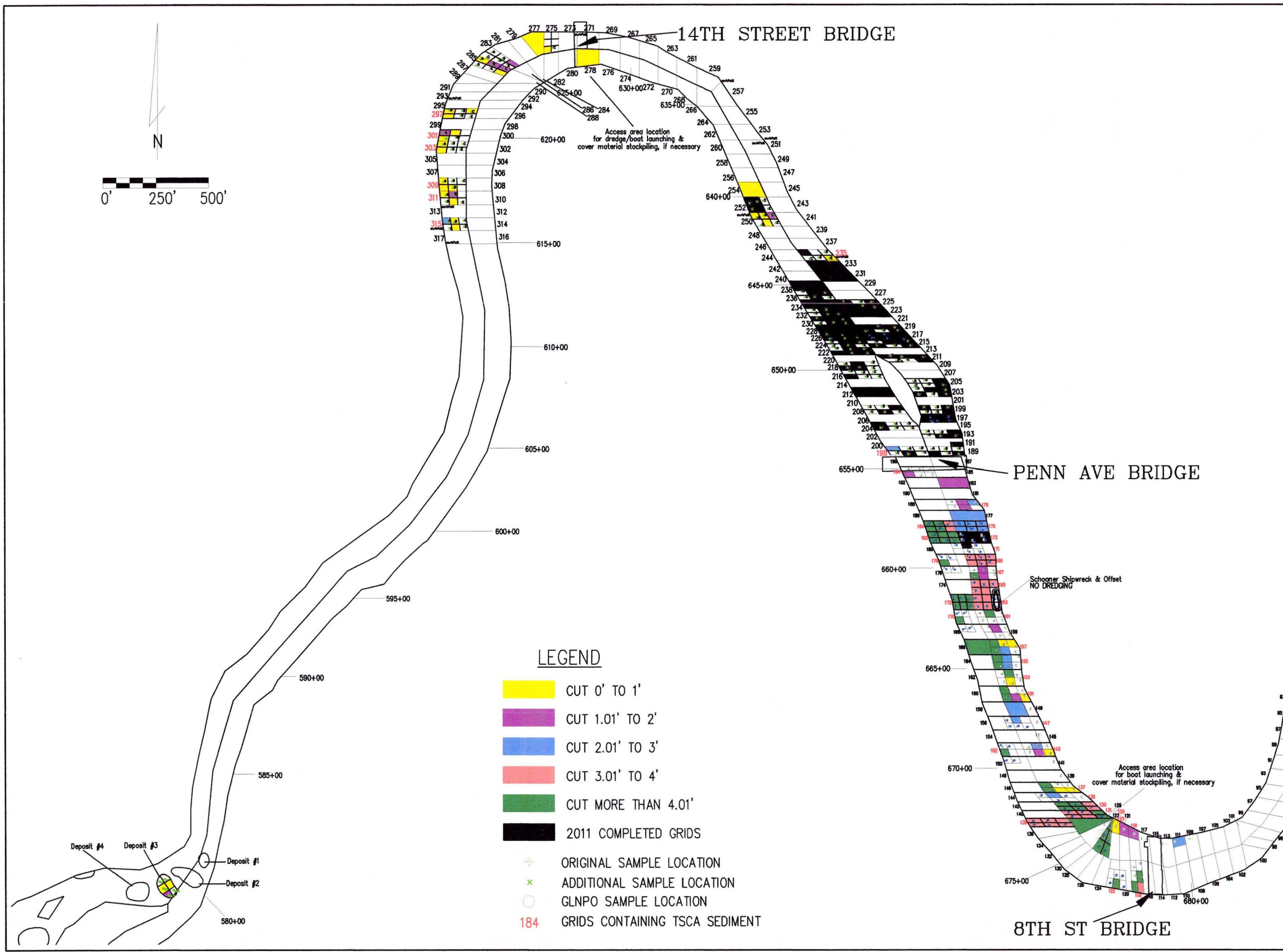

- LEGEND**
- CUT 0' TO 1'
 - CUT 1.01' TO 2'
 - CUT 2.01' TO 3'
 - CUT 3.01' TO 4'
 - CUT MORE THAN 4.01'
 - 2011 COMPLETED GRIDS
 - ORIGINAL SAMPLE LOCATION
 - ADDITIONAL SAMPLE LOCATION
 - GLNPO SAMPLE LOCATION
 - 184 GRIDS CONTAINING TSCA SEDIMENT





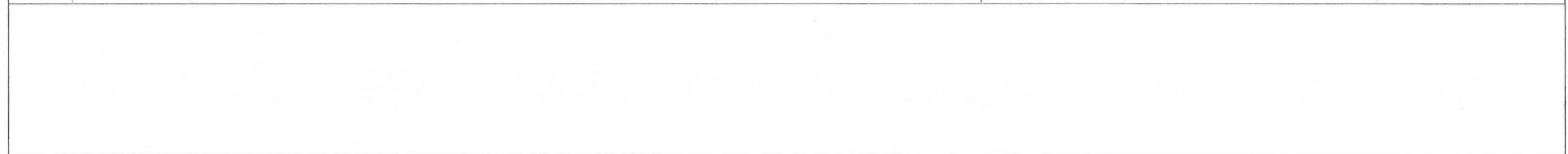

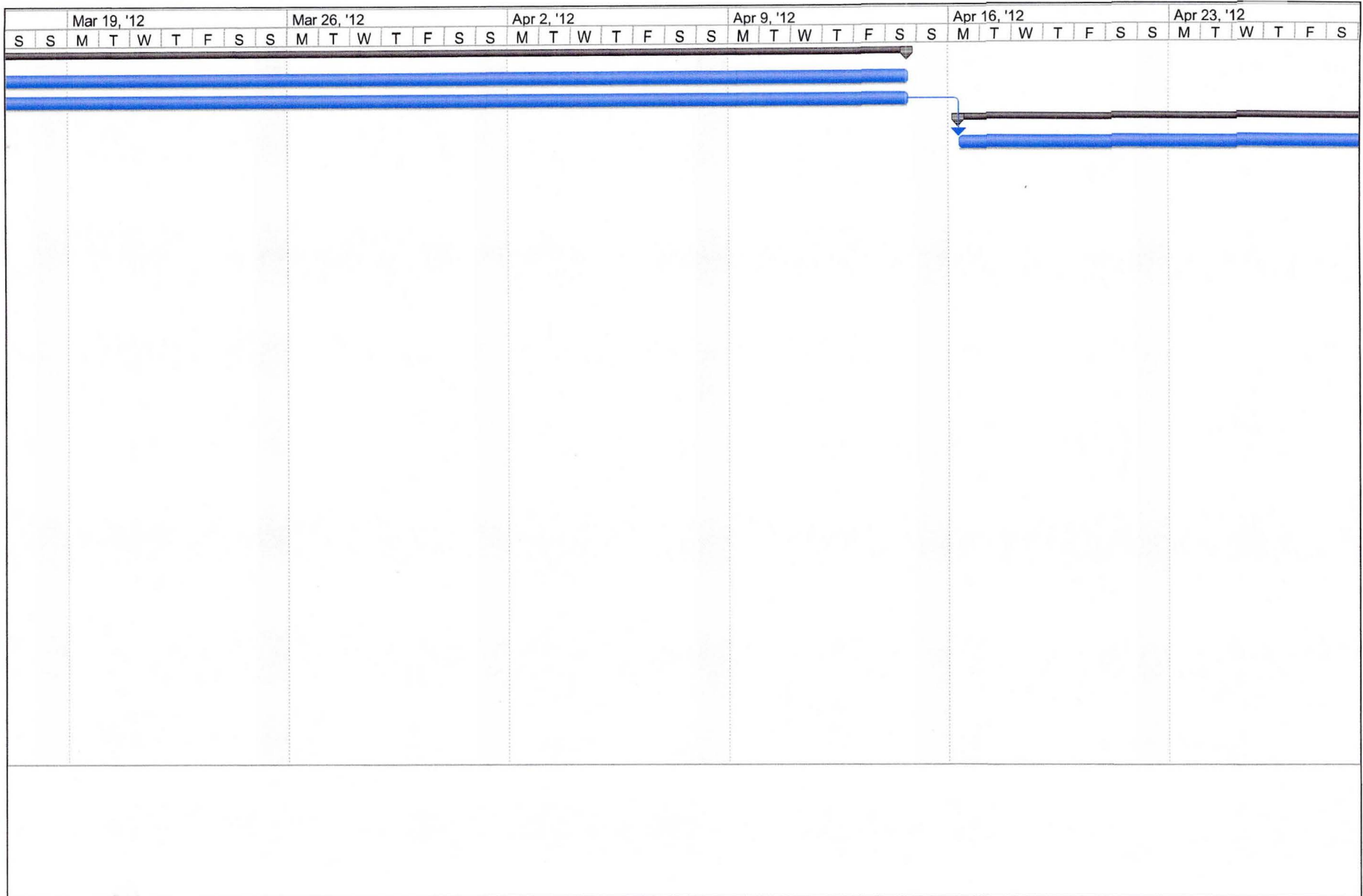

FILE NAME:		DATE:	
DRAWN BY:		DATE:	
SIGNATURES:		DATE:	
BY	DATE	APPROVED	REVIEWED
REVISIONS:		DATE:	
NO.	BY	DATE	REVISIONS
1		FEBRUARY 2011	
 Pollution Risk Services 7870 East Kemper Road, Suite 240 Cincinnati, Ohio 45249 Phone: 513-489-2793 Fax: 513-489-2794			
SHEBOYGAN RIVER AND HARBOR SUPERFUND SITE REMEDIAL ACTION WORK PLAN SHEBOYGAN FALLS, WISCONSIN		DREDGE LOCATIONS	
Scale: SHOWN			
FIGURE NO. 1			

ID	Task Name	Duration	Start	Finish	Predecessors	Mar 5, '12							Mar 12, '12							
						T	F	S	S	M	T	W	T	F	S	S	M	T	W	T
1	Re-mobilize	30 days	Mon 3/12/12	Sat 4/14/12																
2	Dredge - Marine Equipment	30 days	Mon 3/12/12	Sat 4/14/12																
3	WWTP, Dewatering Pad	30 days	Mon 3/12/12	Sat 4/14/12																
4	Iteration #1	39 days	Mon 4/16/12	Thu 5/31/12																
5	IH Grid 111/110 - 133/142	23 days	Mon 4/16/12	Fri 5/11/12 3																
6	Bathymetry & Sampling	5 days	Sat 5/12/12	Thu 5/17/12 5																
7	Loading Prep & Dry Time	2 days	Sat 5/12/12	Mon 5/14/12 5																
8	Load-out Non-TSCA	10 days	Tue 5/15/12	Fri 5/25/12 7																
9	Load-out TSCA	4 days	Sat 5/26/12	Thu 5/31/12 8																
10	Iteration #2	39 days	Fri 6/1/12	Wed 7/18/12																
11	IH Grid 135/144 - 172	23 days	Fri 6/1/12	Wed 6/27/12 9																
12	Bathymetry & Sampling	5 days	Thu 6/28/12	Thu 7/5/12 11																
13	Loading Prep & Dry Time	2 days	Thu 6/28/12	Fri 6/29/12 11																
14	Load-out Non-TSCA	10 days	Sat 6/30/12	Fri 7/13/12 13																
15	Load-out TSCA	4 days	Sat 7/14/12	Wed 7/18/12 14																
16	Iteration #3	31 days	Thu 7/19/12	Thu 8/23/12																
17	IH Grid 163 - 194/185	19 days	Thu 7/19/12	Thu 8/9/12 15																
18	Bathymetry & Sampling	5 days	Fri 8/10/12	Wed 8/15/12 17																
19	Loading Prep & Dry Time	2 days	Fri 8/10/12	Sat 8/11/12 17																
20	Load-out Non-TSCA	7 days	Mon 8/13/12	Mon 8/20/12 19																
21	Load-out TSCA	3 days	Tue 8/21/12	Thu 8/23/12 20																
22	Iteration #4	17 days	Fri 8/24/12	Thu 9/13/12																
23	IH Mitigation Dredging	8 days	Fri 8/24/12	Sat 9/1/12 21																
24	LR Re-dredge 278, 254, 250, 235, 198	3 days	Tue 9/4/12	Thu 9/6/12 23																
25	LR (Grid 315 - 297)	8 days	Fri 8/24/12	Sat 9/1/12 21																
26	LR Re-dredge 285, 277, 275	3 days	Tue 9/4/12	Thu 9/6/12 25																
27	Bathymetry & Sampling	5 days	Fri 9/7/12	Wed 9/12/12 26																
28	Loading Prep & Dry Time	2 days	Fri 9/7/12	Sat 9/8/12 26																
29	Load-out Non-TSCA	3 days	Mon 9/10/12	Wed 9/12/12 28																
30	Load-out TSCA	1 day	Thu 9/13/12	Thu 9/13/12 29																
31	Demobilization	33 days	Fri 9/7/12	Mon 10/15/12																
32	Dredge - Marine Equipment	10 days	Fri 9/7/12	Tue 9/18/12 26																
33	Dewatering Pad, WWTP	28 days	Thu 9/13/12	Mon 10/15/12 27																



Project: Project Schedule.Rev12 Date: Tue 1/31/12	Task		Milestone		External Tasks	
	Split		Summary		External Milestone	
	Progress		Project Summary		Deadline	



Project: Project Schedule.Rev12 Date: Tue 1/31/12	Task		Milestone		External Tasks	
	Split		Summary		External Milestone	
	Progress		Project Summary		Deadline	

Apr 30, '12							May 7, '12							May 14, '12							May 21, '12							May 28, '12							Jun 4, '12						
S	M	T	W	T	F	S	S	M	T	W	T	F	S	S	M	T	W	T	F	S	S	M	T	W	T	F	S	S	M	T	W	T	F	S	S	M	T	W	T	F	S

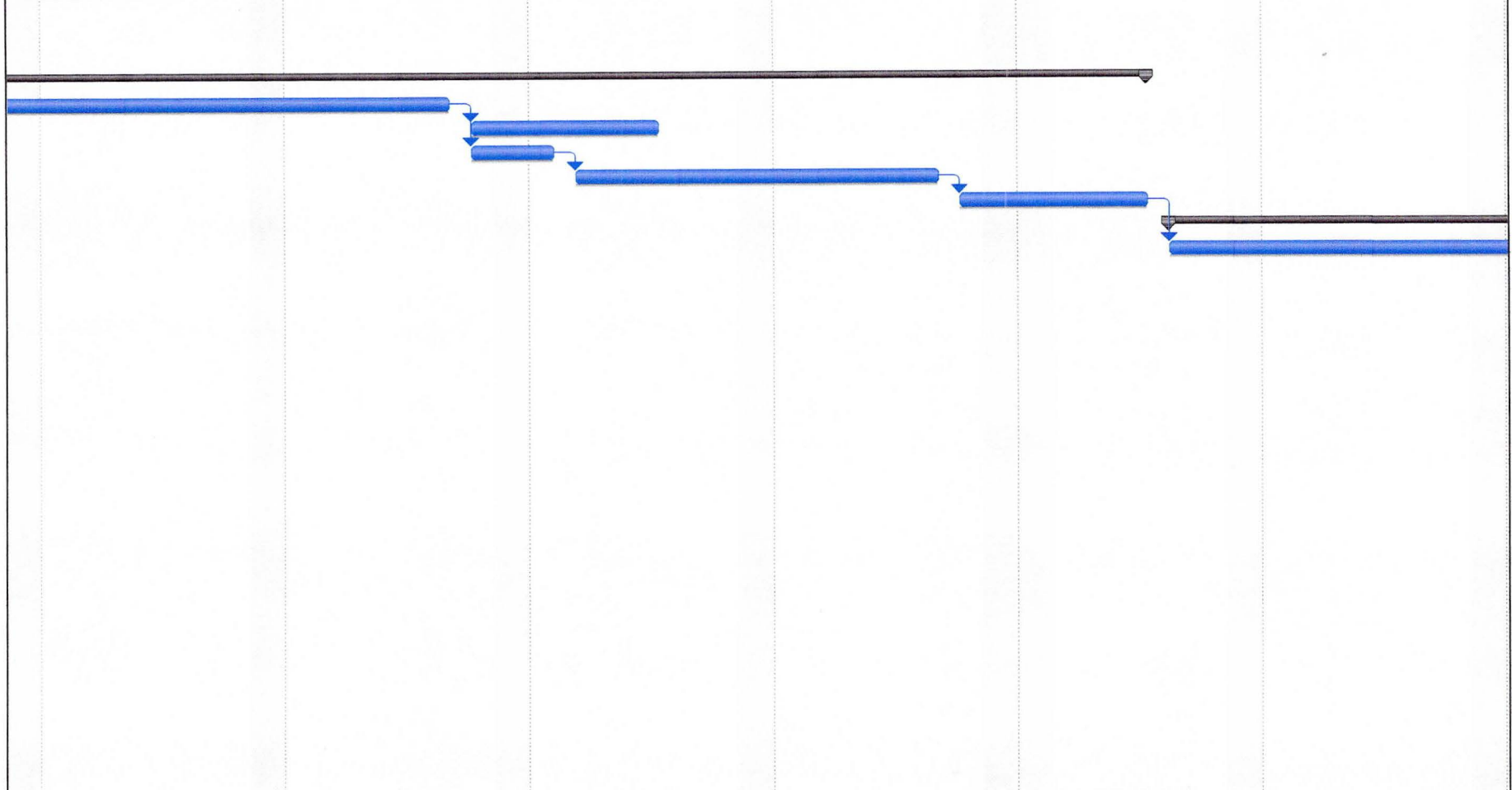

Project: Project Schedule.Rev12 Date: Tue 1/31/12	Task		Milestone		External Tasks	
	Split		Summary		External Milestone	
	Progress		Project Summary		Deadline	

Jun 11, '12 Jun 18, '12 Jun 25, '12 Jul 2, '12 Jul 9, '12 Jul 16, '12 Jul

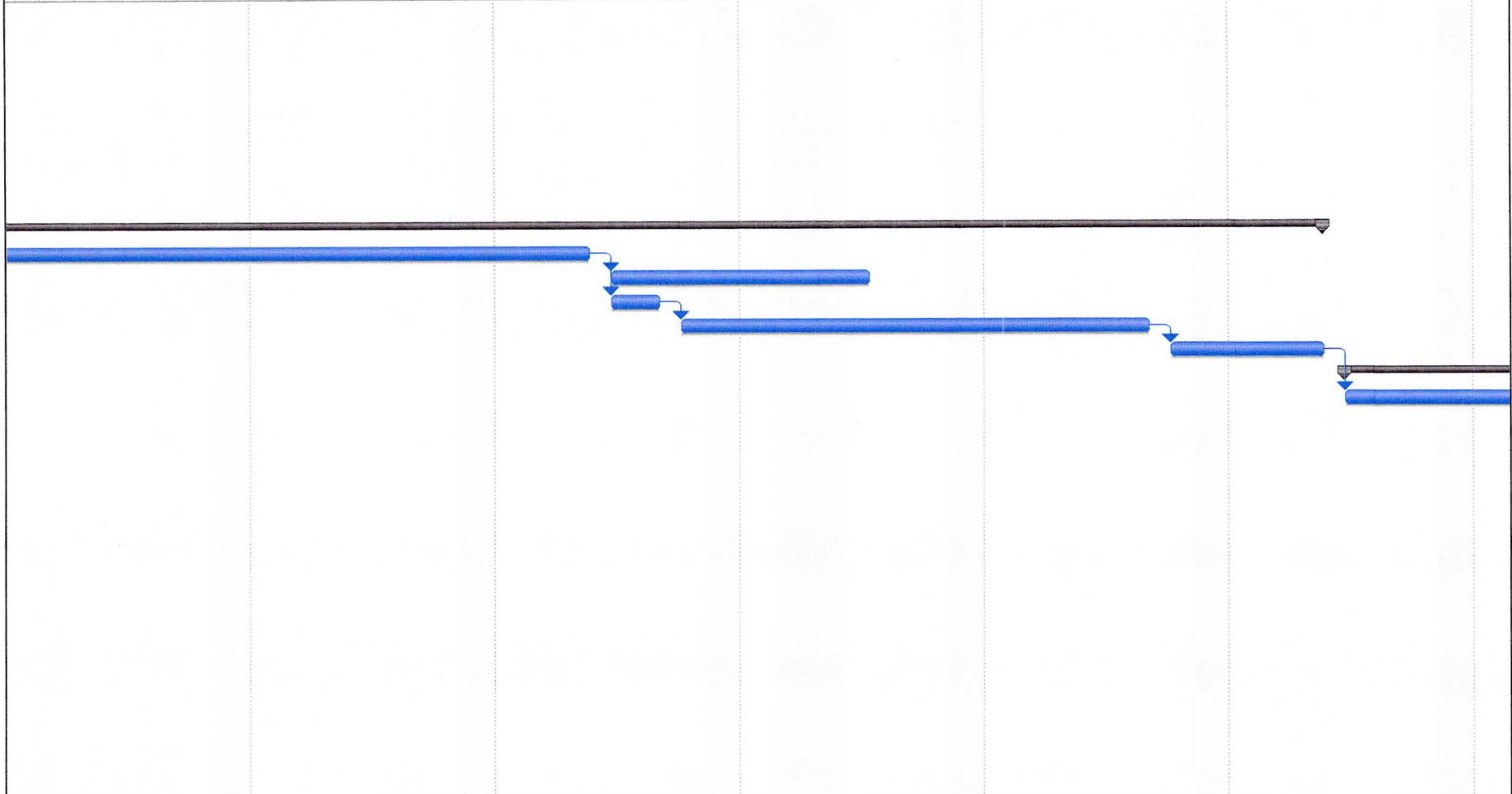

Project: Project Schedule.Rev12
 Date: Tue 1/31/12

Task		Milestone		External Tasks	
Split		Summary		External Milestone	
Progress		Project Summary		Deadline	

3, '12 Jul 30, '12 Aug 6, '12 Aug 13, '12 Aug 20, '12 Aug 27, '12 Sep 3, '12

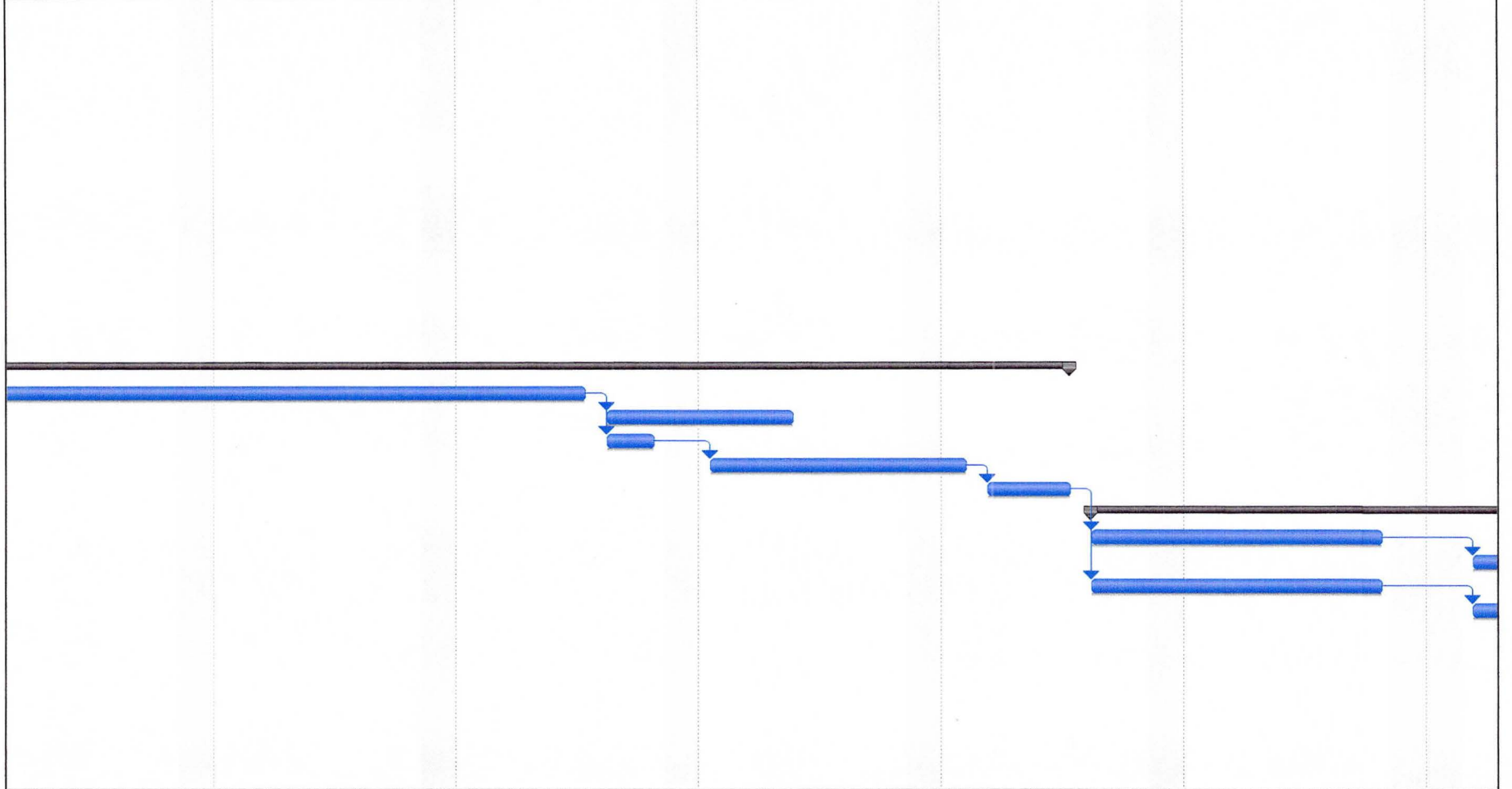

Project: Project Schedule.Rev12 Date: Tue 1/31/12	Task		Milestone		External Tasks	
	Split		Summary		External Milestone	
	Progress		Project Summary		Deadline	

Sep 10, '12 Sep 17, '12 Sep 24, '12 Oct 1, '12 Oct 8, '12 Oct 15, '12
 W T F S S M T W T F S S M T W T F S S M T W T F S S M T W T F S S M T W

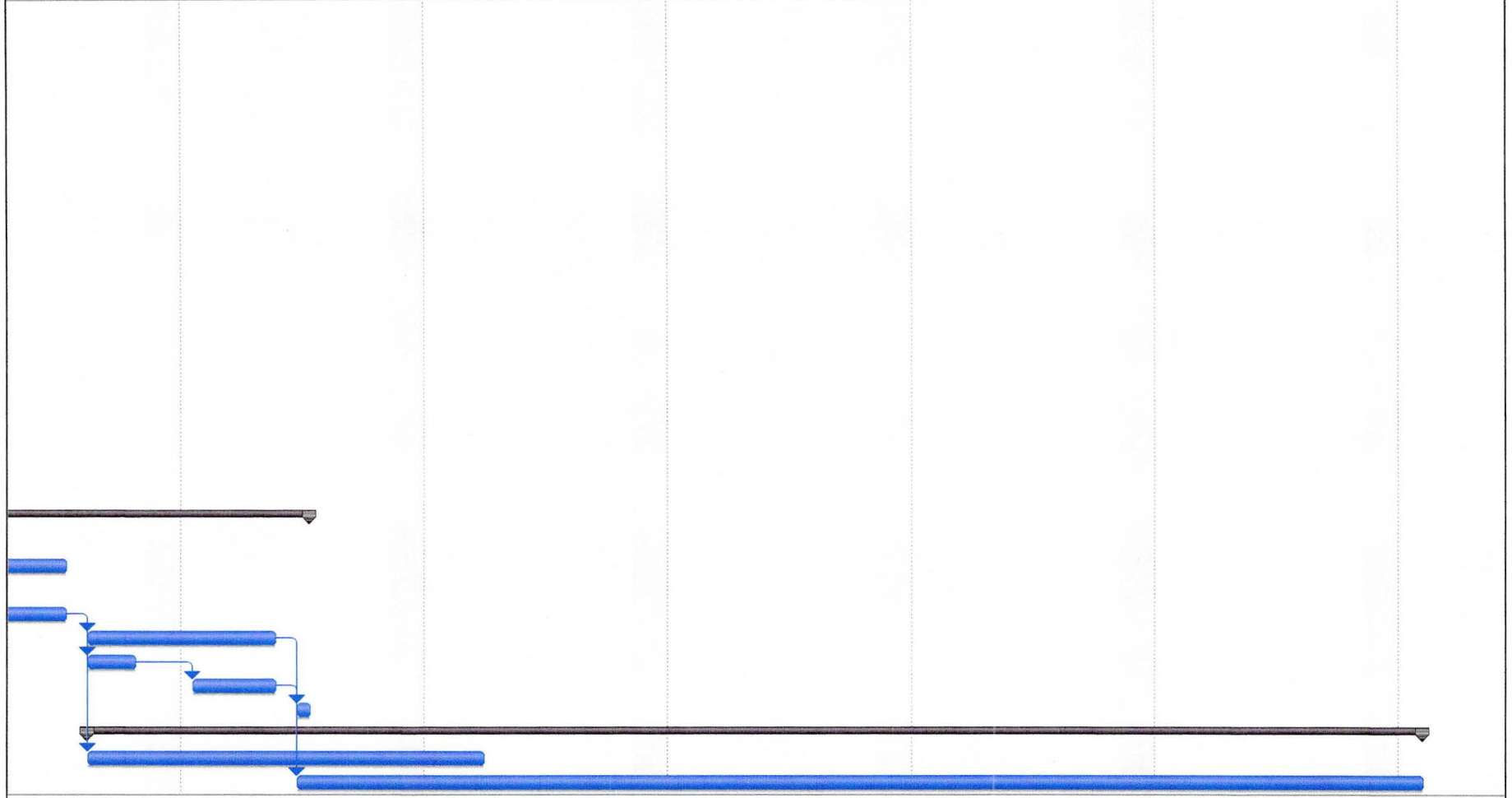

Project: Project Schedule.Rev12
 Date: Tue 1/31/12

Task		Milestone		External Tasks	
Split		Summary		External Milestone	
Progress		Project Summary		Deadline	

FIRE EXTINGUISHING MEDIA:

Use method appropriate for surrounding fire. This material is not expected to burn unless heated to dryness. Dry residue may ignite. Use water, foam, carbon dioxide or dry chemical to extinguish fire if this occurs.

SPECIAL FIRE FIGHTING PROCEDURES:

Firefighters should wear protective clothing and positive pressure self-contained breathing apparatus when fighting fires near chemicals. Cool exposed tanks with water.

UNUSUAL FIRE AND EXPLOSION HAZARDS:

Thermal decomposition (as may be experienced in a fire) may produce hydrogen chloride gas or may liberate oxides of nitrogen and carbon. Keep containers cool by spraying with water, if exposed to fire. Spills may be slippery and could present a physical hazard for firemen.

6. REACTIVITY DATA**STABILITY:**

Stable

CONDITIONS TO AVOID:

None Known

INCOMPATIBILITY (Materials to Avoid):

Strong Oxidizers; Contact with copper, copper, alloys, aluminum, mild steel or iron may cause corrosion/degradation.

HAZARDOUS DECOMPOSITION OF PRODUCTS:

Thermal decomposition (as may be experienced in a fire) may produce hydrogen chloride gas and/or oxides of nitrogen and carbon.

HAZARDOUS POLYMERIZATION:

Will Not Occur

CONDITIONS TO AVOID:

None Known

7. HEALTH HAZARD DATA**EFFECTS OF ACUTE OVEREXPOSURE:****EYES:**

None expected, but prolonged or repeated eye contact may result in mild irritation and redness. Reaction is of a short-term nature.

SKIN:

None expected, but prolonged or repeated skin contact may result in irritation. Reactions are of a short-term nature.

INHALATION:

None expected. Although unlikely to occur, inhalation could result in an adverse reaction to persons previously sensitized to the material.

INGESTION:

Effects of ingesting small amounts are negligible; ingesting large amounts may injure slightly. Acute oral toxicity in Albino Rats was found to be LD₅₀ = 5000 mg/kg.

EMERGENCY FIRST AID PROCEDURES:**EYES:**

Immediately flush eyes for 15 minutes with plenty of water and keep eyelids open as much as possible. Call a physician.

SKIN:

Flush skin with soap and water for at least 15 minutes to avoid rash. Remove contaminated clothing and wash before re-use.

INHALATION:

Remove person to fresh air and watch for delayed reaction. Give artificial respiration if breathing stops and get medical attention.

INGESTION:

If swallowed, do not induce vomiting. Consult a physician immediately. Never give anything by mouth to an unconscious person.

EFFECTS OF CHRONIC EXPOSURE:

Prolonged or repeated exposure may cause dermatitis of the skin.

CARCINOGENICITY:

Neither NTP, IARC, OSHA nor ACGIH lists any of the components of this material as a carcinogen.

AQUATIC TOXICITY:

Bluegill Sunfish (*Lepomis macrochirus*), 96 hour LC50: 0.14 mg/L

Rainbow Trout (*Oncorhynchus mykiss*), 96 hour LC50: 0.22 mg/L

Fathead Minnow (*Pimephales promelas*), 96 hour LC50: 0.40 mg/L

Water Flea (*Daphnia magna*), 48 hour EC50: 0.14 mg/L

Water Flea (*Ceriodaphnia dubia*), 48 hour EC50: 0.17 mg/L

NOTE: Aquatic toxicity is reduced by factors of 10 to 100 times in the presence of 5 to 10 mg/L organic carbon as is found in most surface waters.

8. PRECAUTIONS FOR SAFE HANDLING & USE**STEPS TO BE TAKEN IF MATERIAL IS SPILLED OR LEAKED:**

Persons performing cleanup work should wear protective equipment and clothing. Dike area around spill immediately to prevent spreading. Avoid runoff into storm sewers and ditches that lead to waterways. Clean up spill immediately using inert absorbent materials such as clays, sand, earth or other commercially available dry sweeping compound. Product may cause slip hazard. If slippery conditions persist, apply additional dry sweeping compound. Following containment, large spills should be pumped into salvage tanks.

WASTE DISPOSAL METHODS:

Recycle, if possible. If not, dispose of the waste material in accordance with all applicable federal, state and local laws and regulations regarding health and pollution. Under the Resource Conservation and Recovery Act (RCRA), it is the responsibility of the user to determine whether a material should be classified waste at the time of the disposal. This is due to the fact that product use, transformation, synthesis, mixing, etc. may change the nature of the product.

HANDLING AND STORAGE PRECAUTIONS:

Keep containers closed and tightly sealed while handling and storing. Store containers in a cool area. However, avoid storage temperatures below freezing, since product may stratify. A water source and shower should be installed in storage and work areas. Wash exposed areas thoroughly after handling. Remove and wash any contaminated clothing.

OTHER PRECAUTIONS:

Keep containers tightly sealed when not in use. Use adequate ventilation around containers. Changes in temperature create air pressure changes inside drums. Use proper precaution in unscrewing plug and/or opening container. Avoid contact with eyes, skin and clothing.

9. PERSONNEL CONTROL MEASURES**RESPIRATORY PROTECTION AND VENTILATION:**

Under most conditions, use adequate general ventilation and protective equipment since volatility and toxicity are very low. If significant vapors, mists or aerosols are present, use NIOSH approved respirator (ANSI Z882.1980) or equivalent, that is equipped with a dust/mist cartridge.

EYE PROTECTION:

Wear goggles or safety glasses with eye shields. Wear a face shield if the possibility of material splashing or spraying exists. Do not wear contact lenses when working with chemicals. Eyewash and safety shower stations in the work area are recommended.

HAND/BODY PROTECTIVE CLOTHING AND EQUIPMENT:

While there is a possibility of skin contact, use the following protective equipment as appropriate: gloves impervious to liquid material, apron, boots, hood, pants and jacket.

WORK/HYGIENIC PRACTICES:

If clothing is contaminated, wash skin and launder clothing. After handling material and before eating, drinking or smoking, wash face and hands thoroughly with soap and water.

10. NFPA/HMIS RATINGS AND HAZARD CLASS

NFPA/HMIS RATINGS:	HEALTH:	1
	FLAMMABILITY:	0
	REACTIVITY:	0
	PERSONAL PROTECTION:	0

HAZARD CLASSIFICATIONS:

ACUTE:	NO	CHRONIC:	NO
FIRE:	NO	REACTIVE:	NO
PRESSURE:	NO	TOXIC:	NO

CERCLA-SARA HAZARD CATEGORY:

No SARA Section 313 components exist in this product.

US TSCA:

This product is made in compliance with all provisions of Toxic Substances Control Act, 15 U.S.C.

CANADA DSL:

Components of this product have been reported to Environment Canada in accordance with subsection 25 of the Canadian Environmental Protection Act and are included on the Domestic Substances List.

The information and recommendations contained herein are based upon data from suppliers and the work of others, and is believed to be correct. However, AQUAMARK Inc. makes no guarantee or warranty of any kind, expressed or implied, as to the accuracy, completeness, or adequacy of the information contained herein. This Material Safety Data Sheet was made to comply with OSHA Hazard Communication Standard (29 CFR 1910.2000). Although certain hazards are described in this sheet, we cannot guarantee that these are the only hazards that exist. Users of any chemical should educate themselves on all aspects of its use by independent investigation of current scientific and medical knowledge that the material can be used safely.

Appendix C
Dewatering Area Layout

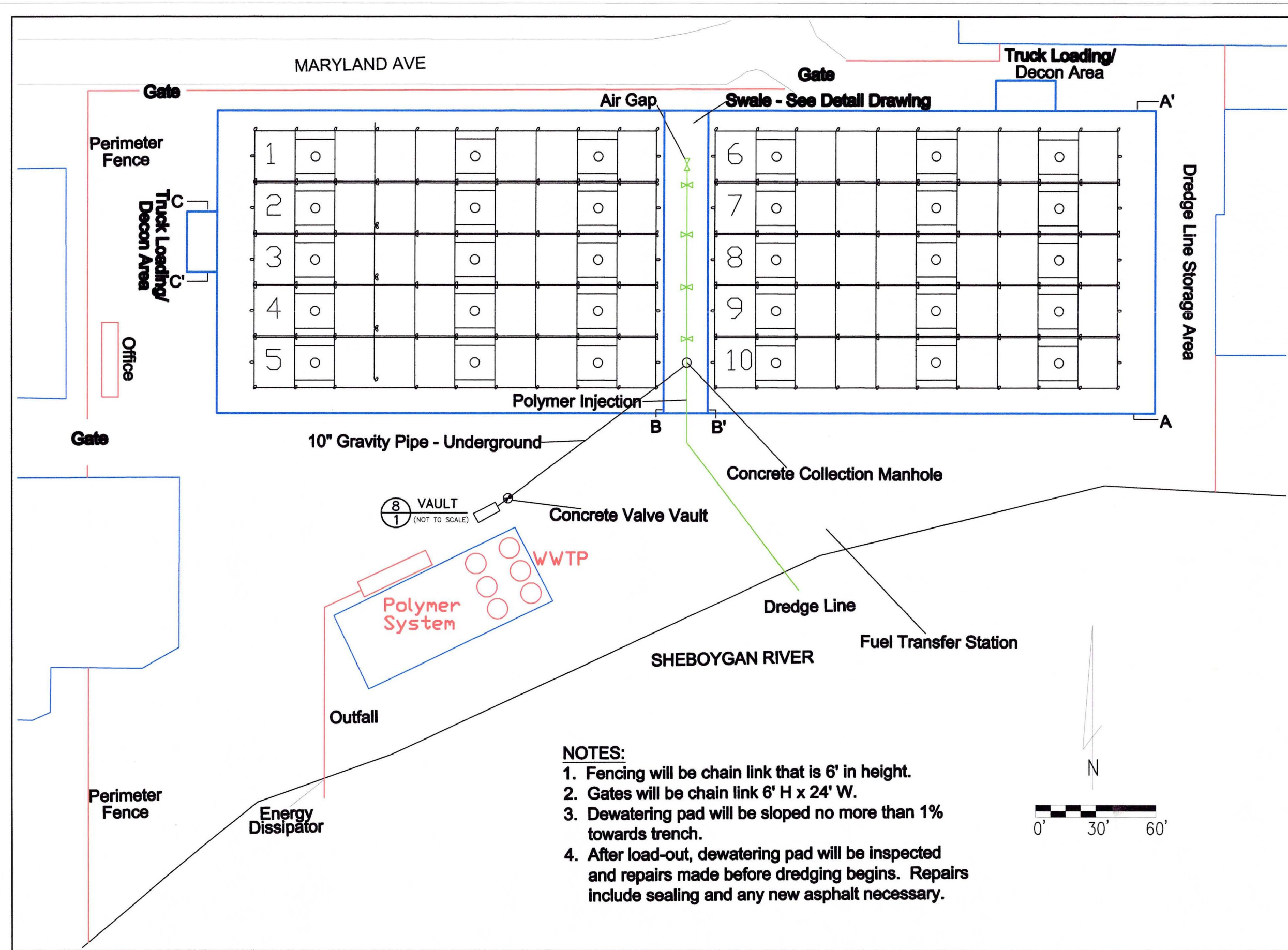

- NOTES:**
1. Fencing will be chain link that is 6' in height.
 2. Gates will be chain link 6' H x 24' W.
 3. Dewatering pad will be sloped no more than 1% towards trench.
 4. After load-out, dewatering pad will be inspected and repairs made before dredging begins. Repairs include sealing and any new asphalt necessary.

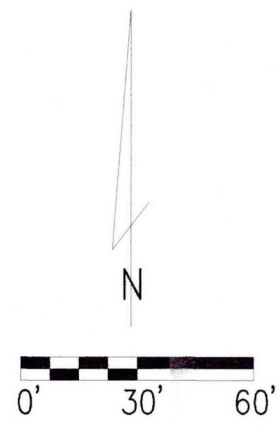

FILE NAME: DRAWN BY: DATE: NOVEMBER 2000	
REVISIONS NO. BY DATE 1. BY IDA NOVEMBER 17, 2000	SIGNATURES BY DATE APPROVED REVIEWED DESIGNED
7870 East Kemper Road, Suite 240 Cincinnati, Ohio 45249 Phone: 513-489-2793 Fax: 513-489-2794	
SHEBOYGAN RIVER AND HARBOR SUPERFUND SITE LOWER RIVER RAMP SHEBOYGAN FALLS, WISCONSIN	AS-BUILT FOR DEWATERING AREA
Scale: SHOWN	
FIGURE NO. 1	

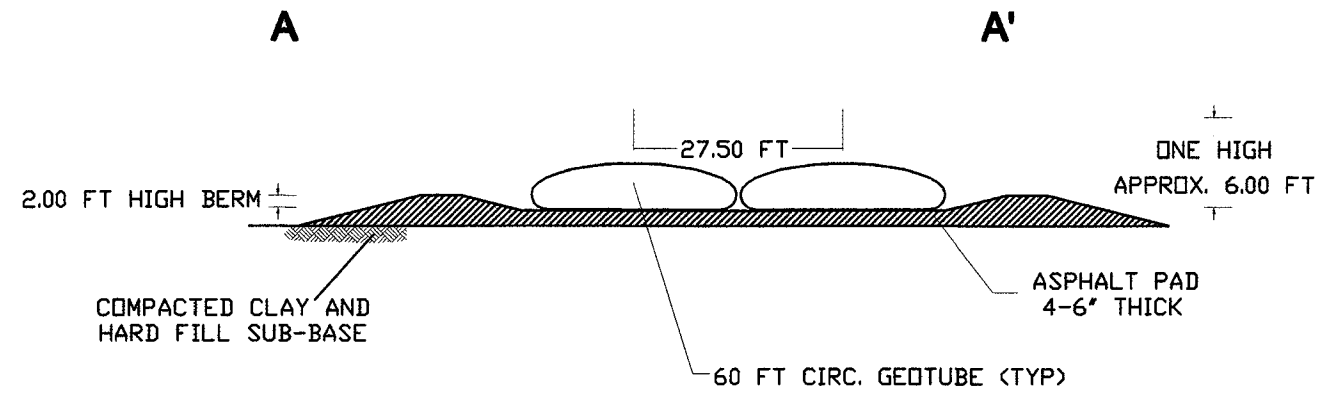

SECTION VIEW - DEWATERING PAD DETAIL

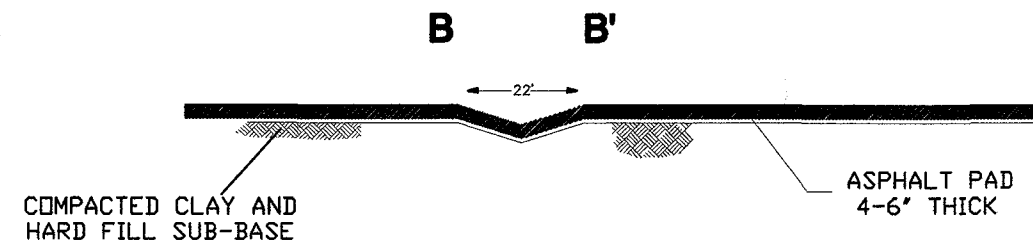

SECTION VIEW - TRENCH DETAIL

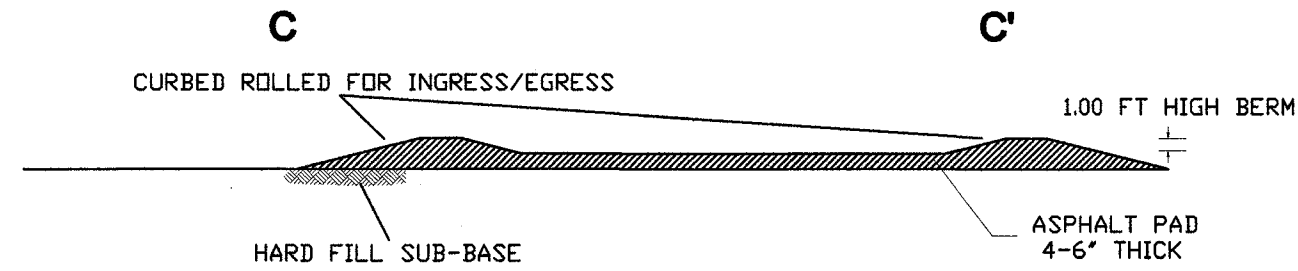

SECTION VIEW - TRUCK LOADING/DECONTAMINATION AREA DETAIL

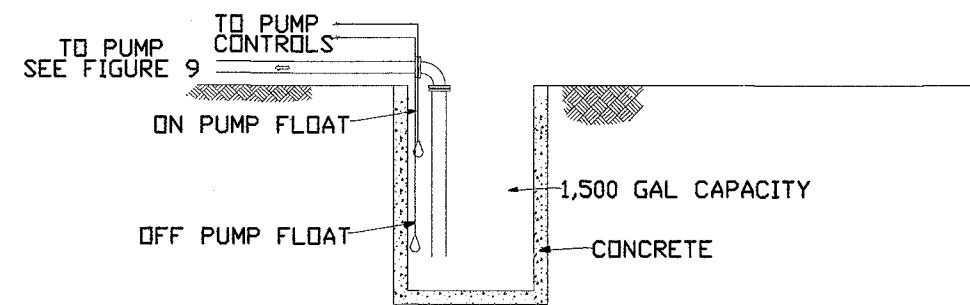

8 VAULT DETAIL
(NOT TO SCALE)

FILE NAME	NO.	DATE	BY	DATE	BY	DATE	BY
REVISIONS	NO.	DATE	BY	DATE	BY	DATE	BY
DESIGNED							
REVIEWED							
APPROVED							

Pollution Risk Services
 PRS
 7870 East Kemper Road, Suite 240
 Cincinnati, Ohio 45249
 Phone: 513-489-2793
 Fax: 513-489-2794

SENECA RIVER AND HARBOR SUPERFUND SITE
 LOWER RIVER RAMP
 SENECA FALLS, WISCONSIN
 AS-BUILT FOR DEWATERING AREA

Scale:
 NOT TO SCALE

FIGURE NO.
 2

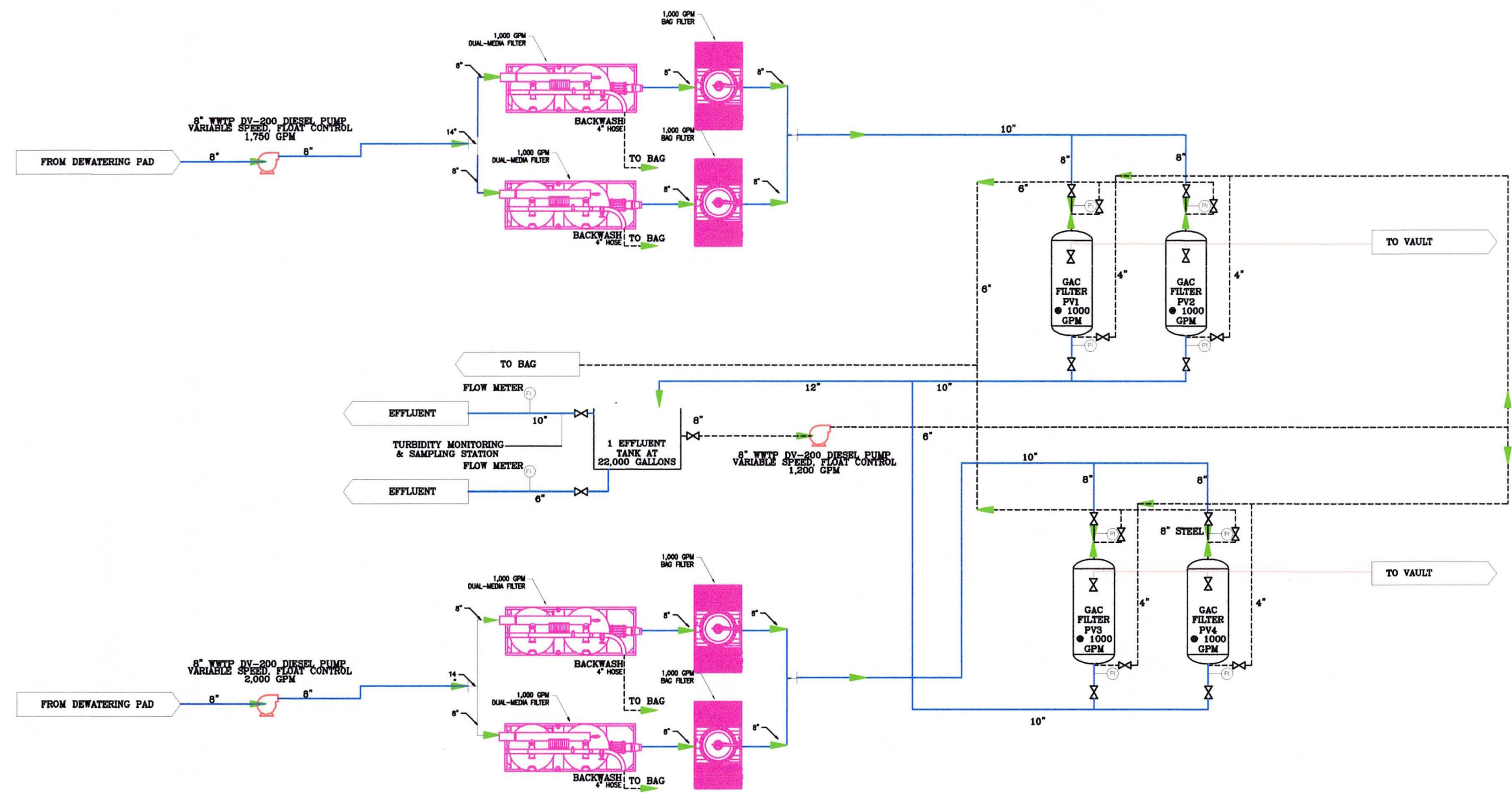

- NOTES
1. GAC FILTERS PROVIDED BY CALGON CORPORATION.
 2. FILTER PIPING WILL BE 8" STEEL AND PROVIDED BY CALGON CORPORATION.
 3. ALL OTHER PIPING WILL BE PVC/HDPE IN ACCORDANCE WITH SPECIFICATIONS IN SIZES NOTED ON DRAWING.
 4. OUTFALL WILL BE LINED WITH RIPRAP IN ACCORDANCE WITH SPECIFICATION #02271 FOR EROSION CONTROL.

LEGEND

- V#A Operational valve shut off location
- Operational Flow
- Backwash Flow
- Pressure Relief Vent Line

SIGNATURES		FILE NAME:	NOVEMBER 2009
BY	DATE	DRAWN BY:	DATE:
NO.	DATE	NO.	DATE:
BY	DATE	BY	DATE:
NO.	DATE	NO.	DATE:
BY	DATE	BY	DATE:
REVISIONS			
NO.	DATE	NO.	DATE:
BY	DATE	BY	DATE:
NO.	DATE	NO.	DATE:
BY	DATE	BY	DATE:
RECORD DRAWINGS OF COMPLETED CONSTRUCTION CONTAINING TO CONTRACTORS AND/OR OWNERS RECORDS BY DATE			
DESIGNED			
REVIEWED			
APPROVED			
DATE: NOVEMBER 2009			
<p>PR Pollution Risk Services</p> <p>7870 E Kemper Rd, Suite 240 Cincinnati, Ohio 45249 Phone: 513-489-7793 Fax: 513-489-7794</p>			
SHEBOYGAN RIVER AND HARBOR SUPERFUND SITE		REVISED AS-BUILT	
LOWER RIVER RAMP		WWT PROCESS FLOW DIAGRAM	
SHEBOYGAN FALLS, WISCONSIN		SCALE	
		NOT TO SCALE	
FIGURE NO.			
1			

REVISION OF DOCUMENTS
THIS DOCUMENT HAS BEEN DEVELOPED FOR A SPECIFIC PROJECT AND IS NOT TO BE USED WITHOUT THE WRITTEN APPROVAL OF PRS & V&E. THIS DOCUMENT IS UNAPPROVED USE IS THE SOLE RESPONSIBILITY OF THE UNAPPROVED USER.

Sediment Management Plan
Sheboygan River and Harbor Superfund Site
Sheboygan County, Wisconsin

March 2011

Revised February 2012

Prepared By

Pollution Risk Services, LLC



TABLE OF CONTENTS

1.0	INTRODUCTION	1
2.0	EQUIPMENT	2
3.0	MEANS AND METHODS	3
4.0	BEST MANAGEMENT PRACTICES.....	6
6.0	QUALITY ASSURANCE/QUALITY CONTROL	8
7.0	FUELING.....	9
8.0	DECONTAMINATION	10

Figures

Figure 1 Secondary Staging Area

1.0 INTRODUCTION

This Sediment Management Plan (SMP) is an appendix to the Remedial Action Work Plan (RAWP). The scope of the Lower River Remedial Action includes off-site disposal of dredged sediment. The purpose of this document is to provide plans for managing this material, including describing:

- Details regarding the transportation of dredged sediments, including loading material, adding drying agent (if necessary), and transport by truck to the disposal facility;
- Best Management Practices (BMPs) for any spills that might occur in accordance with Design's Contingency Plan. The specific contingencies and "stop work" issue will be addressed as part of the Preparatory Phase Meeting for the Sediment Management definable work feature; and
- Details regarding the disposal of dredged sediment, including the disposal facility locations.

2.0 EQUIPMENT

The following equipment will be used for the transportation and disposal of sediment waste, and for the overland transportation of the dewatered TSCA and wet mechanical dredge sediment upstream of the 14th Street Bridge to the 415 Cleveland Street dewatering/staging area:

- The primary equipment used for loading sediment will be an excavator equipped with 48-inch-wide bucket located outside the pad in the “loading area”. In addition, a rubber tire loader equipped with a bucket will be used to push sediment to the excavator, as necessary.
- Haul units will be 4-axle and/or 8-axle end-dump on-highway trucks with sealed tailgates. Operation will start out with eight haul units and may increase to ten depending on efficiency and material flow without compromising cleanliness and safety.

3.0 MEANS AND METHODS

The loading and transportation of dredged sediments are described in the following sections. In general, after drying, the sediments will be loaded onto trucks for transport to the disposal facilities.

Truck Loading

Lined (TSCA) or un-lined (non-TSCA) trucks with sealed tailgates will be used to haul sediments to appropriate disposal facilities. Truck-loading operations at the 2025 Maryland Avenue dewatering area will be performed at two bermed loading/decontamination areas, one located on the east side and one on the west side of the dewatering pad. If at 415 Cleveland Street, truck-loading operations will be performed at one bermed loading/decontamination area located on the east side of the dewatering pad. Bermed areas will be equipped with pumps, hoses, broom, water sprayer, and shovel to decontaminate, if necessary, trucks and transfer solids and liquids onto the dewatering pad. Equipment buckets will be decontaminated when loading TSCA sediment prior to non-TSCA sediment. Equipment decontamination is discussed in Section 8.

Dewatered and stabilized TSCA sediment from the dewatering area located at 2025 Maryland Avenue and mechanically excavated sediment will be transported to a secondary staging area located at our Sheboygan Falls dewatering site (415 Cleveland Street). Transportation will be performed with trucks described in Section 2 and will follow a WDOT approved truck route as follows:

1. West on New Jersey Avenue.
2. South on Taylor Drive.
3. West on CR PP.
4. South on Water Street.
5. East on Cleveland Street.

The staging area will be constructed to control the run-on and run-off of contact stormwater and drained water from the mechanically dredge sediment with a perimeter berm. Sediment will also be covered to reduce contact with storm events. Figure 1 provides the layout and details of the secondary staging area. Run-on stormwater will be treated with a 30 gpm mobile treatment system equipped with primary bag filtration and secondary Granulated Activated Carbon (GAC) filtration. This technology was used to treat water during the 2011/2012 winterization period with success in meeting the discharge requirements. Water will be monitored per the requirements of the WPDES permit provided in Appendix A of the Water Management Plan. The only change will be that the effluent TSS, BOD, and PCB samples will be collected as a grab instead of a composite. The rationale behind this is that this system will operate as a batch process with much lower daily flowrates in the order of 5,000-10,000 gallons per day.

Sediment Drying

The Geo-textile tube is the primary method for separating water from the sediment. TSCA and non-TSCA sediment will be confined in the geotextile tube until mixing/loading. TSCA sediment will be staged for loading on the down gradient side of the dewatering pad to avoid cross contamination. If sediment does not meet the landfill parameters, then the secondary method will be air drying. If sediment still does not meet the landfill parameters, then the tertiary method of adding drying agents will be employed to accelerate the drying process. An inert material (i.e. bed ash/fly ash) will be used. These materials were used in 2011 and found to effective in appropriately drying the sediment to meet the landfill requirements. To prevent from becoming airborne, the material will be wetted, as necessary. The anticipated amount of drying agent that will be added to the sediment is approximately 9 to 10 percent by weight. This mixture ratio will be adjusted as necessary to absorb free liquids in the sediment before it is sent to the landfill. Drying agent material will be stockpiled and mixed with the sediment within the confinements of the dewatering area.

Disposal Facility

Non-TSCA material will be transported to Waste Management (Manitowoc) landfill. Haul routes will be those regulated for use. Transportation will follow a WDOT approved truck route.

TSCA material will be transported to Environmental Quality (Wayne) landfill in Michigan or to Clean Harbors in Oklahoma from 415 Cleveland Street. Transportation will follow a WDOT approved truck route.

Upon entering the disposal facility, truck drivers will conform to the facility's health and safety procedures at all times while on-site. Shipments will be weighed at the disposal facility to determine the quantity of sediment sent to the disposal facility. Weight records will be maintained electronically in the project file.

Waste Profiling

A waste disposal approval letter will be provided by the disposal facility. This document will be maintained in the project office throughout the duration of remediation and will include the following information:

- Identity of the disposal facility (to include: name, address, and EPA I.D. #);
- Identity of the material covered by the Certificate (include: manifest number);
- Statement certifying disposal of the identified material (include date(s) of disposal and disposal process used); and
- Certification as defined in 40 CFR 761, Section 3.

Compliance Status

The USEPA Region 5 confirmed from previous work conducted on the Sheboygan River in 2011 that the Waste Management landfill meets the requirements for accepting non-TSCA (less than 50 ppm) sediment and that EQ and Clean Harbor landfills meet the requirement for accepting TSCA (50 ppm or greater) sediment.

Documentation and Tracking

Each shipment sent to the disposal facility will be accompanied by a manifest. Transporter certification of the waste activities and EPA ID numbers will be submitted. Records of shipments sent and logged into the disposal facility will be reconciled on a daily basis by the Project Manager. The disposal facility will provide weight records and confirmation of shipments received to the Project Manager. The Project Manager will maintain an electronic log of shipments to the disposal facility and the weight of each shipment. The weights of all loads of sediment removed from the site will be provided in the Construction Complete Report.

4.0 BEST MANAGEMENT PRACTICES

Precautions to protect the environment during loading and transporting will be implemented throughout the remedial action. Environmental controls for these procedures, and contingencies for potential spills, are described below.

Spill Prevention

BMPs will be implemented during loading and transporting to prevent accidental spills on land. Primary goals include:

- Prevent spilling contaminated sediment or drying agent into surface water at the loading area.
- Prevent tracking contaminated sediment off-site into any area where it may contact water that would be uncontrolled by containment measures.
- Prevent material spilling from the truck during transport from the loading area to the disposal facility.
- Prevent fugitive dust emission during loading.

Operations will be visually observed at all times. If there is a threat of the above goals not being met, work will be stopped and controls will be modified as needed until these goals are met. If, despite these controls, accidental releases of sediment occur, the released sediment will be recovered, conditions leading to the accident will be corrected, and the releases will be documented and reported to the USEPA. BMPs include:

- Slow addition of the drying agent to avoid spills and/or fugitive dust emission.
- Controlled loading of trucks to prevent sloshing.
- Visual inspection of the loading area and the truck prior to releasing the truck.
- Decontamination of tire and surfaces (if necessary) before leaving loading area.
- Application of water when visible dust is observed from roadways, loading area, and other possible sources of dust generation.

Contingencies for Spills

The trucking contractors will be informed prior to start that they will be hauling contaminated sediment. They will acknowledge their understanding and acceptance of responsibility for preventing spills and conducting spill contingency procedures in the event of spills. If a truck accidentally spills (e.g., collision during transport or turns over) the following will immediately occur:

- Once the safety of personnel is ensured, call 911. The truck driver will then estimate to the best of their ability the approximately quantity of material lost (e.g., 30 percent of load).
- The driver will notify the Project Manager immediately via radio or cell phone. The Project Manager will notify the USEPA National Response Center if a reportable quantity of a hazardous substance is released to the environment.

- The Project Manager will notify the project team who will contain the material to the extent practicable. Cleanup will be performed as soon as possible and take precedence over normal site-related activities.
- The Project Manager will complete the Incident Report and notify USEPA personnel for a site meeting and determination of further actions.
- In consultation with the agencies, further actions may include testing in the spill area to determine the extent of spill (if not on paved surfaces) and removing all affected material. Depending on the quantity, these actions may not be necessary.

6.0 QUALITY ASSURANCE/QUALITY CONTROL

During the first week of each load-out phase or any time there is airborne particulates, air monitoring will be performed at two downwind locations along the perimeter of the dewatering pad to assure than no offsite migration has occurred. Sampling and analysis procedures are provided in the *Verification Sampling Plan*.

7.0 FUELING

Fuel transfers will be performed in accordance with U.S. Coast Guard oil transfer procedures. Diesel fuel is stored in 150 and 550 gallon double-wall fuel tanks. All fuel transfer hoses will be inspected, tested, and maintained in accordance with U.S. Coast Guard requirements. Spill procedures will be in accordance with the *Contingency Plan* and *Environmental Protection Plan*.

8.0 DECONTAMINATION

Equipment decontamination will include the following procedures:

- Equipment components in contact with contaminated material will be visually inspected, scraped, and pressure washed. The Preparatory Phase Meeting for the Sediment Management definable work feature will finalize further issues or requirements.
- All latent material will be contained, loaded, and hauled to the designated landfill for proper disposal.
- All decontamination of equipment will be performed within the confinement of either (east or west side of dewatering pad) decontamination station or dewatering pad.

