

Source Property Information

CLOSURE DATE: 12/10/2013

BRRTS #: 03-67-558530
ACTIVITY NAME: Jacobus West Bend Retail Station (Former)
PROPERTY ADDRESS: 103 E Decorah Rd
MUNICIPALITY: West Bend
PARCEL ID #: 291_11192420011

FID #: 267102220

DATCP #:

PECFA#:

***WTM COORDINATES:**

X: 667824 Y: 328173

** Coordinates are in
WTM83, NAD83 (1991)*

WTM COORDINATES REPRESENT:

Approximate Center Of Contaminant Source

Approximate Source Parcel Center

Please check as appropriate: (BRRTS Action Code)

CONTINUING OBLIGATIONS

Contaminated Media for Residual Contamination:

Groundwater Contamination > ES (236)

Contamination in ROW

Off-Source Contamination

*(note: for list of off-source properties
see "Impacted Off-Source Property Information,
Form 4400-246")*

Soil Contamination > *RCL or **SSRCL (232)

Contamination in ROW

Off-Source Contamination

*(note: for list of off-source properties
see "Impacted Off-Source Property Information,
Form 4400-246")*

Site Specific Obligations:

Soil: maintain industrial zoning (220)

*(note: soil contamination concentrations
between non-industrial and industrial levels)*

Structural Impediment (224)

Site Specific Condition (228)

Cover or Barrier (222)

Direct Contact

Soil to GW Pathway

Vapor Mitigation (226)

Maintain Liability Exemption (230)

*(note: local government unit or economic
development corporation was directed to
take a response action)*

Monitoring Wells:

Are all monitoring wells properly abandoned per NR 141? (234)

Yes No N/A

** Residual Contaminant Level*

***Site Specific Residual Contaminant Level*

This Adobe Fillable form is intended to provide a list of information that is required for evaluation for case closure. It is to be used in conjunction with Form 4400-202, Case Closure Request. The closure of a case means that the Department has determined that no further response is required at that time based on the information that has been submitted to the Department.

NOTICE: Completion of this form is mandatory for applications for case closure pursuant to ch. 292, Wis. Stats. and ch. NR 726, Wis. Adm. Code, including cases closed under ch. NR 746 and ch. NR 726. The Department will not consider, or act upon your application, unless all applicable sections are completed on this form and the closure fee and any other applicable fees, required under ch. NR 749, Wis. Adm. Code, Table 1 are included. It is not the Department's intention to use any personally identifiable information from this form for any purpose other than reviewing closure requests and determining the need for additional response action. The Department may provide this information to requesters as required by Wisconsin's Open Records law [ss. 19.31 - 19.39, Wis. Stats.].

BRRTS #: (No Dashes) PARCEL ID #:
ACTIVITY NAME: WTM COORDINATES: X: Y:

CLOSURE DOCUMENTS (the Department adds these items to the final GIS packet for posting on the Registry)

- Closure Letter**
- Maintenance Plan** (if activity is closed with a land use limitation or condition (land use control) under s. 292.12, Wis. Stats.)
- Continuing Obligation Cover Letter** (for property owners affected by residual contamination and/or continuing obligations)
- Conditional Closure Letter**
- Certificate of Completion (COC)** (for VPLE sites)

SOURCE LEGAL DOCUMENTS

- Deed:** The most recent deed as well as legal descriptions, for the **Source Property** (where the contamination originated). Deeds for other, off-source (off-site) properties are located in the **Notification** section.
Note: If a property has been purchased with a land contract and the purchaser has not yet received a deed, a copy of the land contract which includes the legal description shall be submitted instead of the most recent deed. If the property has been inherited, written documentation of the property transfer should be submitted along with the most recent deed.
- Certified Survey Map:** A copy of the certified survey map or the relevant section of the recorded plat map for those properties where the legal description in the most recent deed refers to a certified survey map or a recorded plat map. (lots on subdivided or platted property (e.g. lot 2 of xyz subdivision)).
Figure #: **Title: Plat Survey**
- Signed Statement:** A statement signed by the Responsible Party (RP), which states that he or she believes that the attached legal description accurately describes the correct contaminated property.

MAPS (meeting the visual aid requirements of s. NR 716.15(2)(h))

- Maps must be no larger than 11 x 17 inches unless the map is submitted electronically.
- Location Map:** A map outlining all properties within the contaminated site boundaries on a U.S.G.S. topographic map or plat map in sufficient detail to permit easy location of all parcels. If groundwater standards are exceeded, include the location of all potable wells within 1200 feet of the site.
Note: Due to security reasons municipal wells are not identified on GIS Packet maps. However, the locations of these municipal wells must be identified on Case Closure Request maps.
Figure #: 1 **Title: Site Location Map**
 - Detailed Site Map:** A map that shows all relevant features (buildings, roads, individual property boundaries, contaminant sources, utility lines, monitoring wells and potable wells) within the contaminated area. This map is to show the location of all contaminated public streets, and highway and railroad rights-of-way in relation to the source property and in relation to the boundaries of groundwater contamination exceeding a ch. NR 140 Enforcement Standard (ES), and/or in relation to the boundaries of soil contamination exceeding a Residual Contaminant Level (RCL) or a Site Specific Residual Contaminant Levels (SSRCL) as determined under s. NR 720.09, 720.11 and 720.19.
Figure #: 1 **Title: Site Plan Map**
 - Soil Contamination Contour Map:** For sites closing with residual soil contamination, this map is to show the location of all contaminated soil and a single contour showing the horizontal extent of each area of contiguous residual soil contamination that exceeds a Residual Contaminant Level (RCL) or a Site Specific Residual Contaminant Level (SSRCL) as determined under s. NR 720.09, 720.11 and 720.19.
Figure #: 2A, 2B **Title: Soil Quality Map (2011 UST Removals), Soil Quality Map**

BRRTS #: 03-67-558530

ACTIVITY NAME: JACOBUS WEST BEND RETAIL STATION (FORMER)

MAPS (continued)

- Geologic Cross-Section Map:** A map showing the source location and vertical extent of residual soil contamination exceeding a Residual Contaminant Level (RCL) or a Site Specific Residual Contaminant Level (SSRCL). If groundwater contamination exceeds a ch. NR 140 Enforcement Standard (ES) when closure is requested, show the source location and vertical extent, water table and piezometric elevations, and locations and elevations of geologic units, bedrock and confining units, if any.

Figure #: 3, 4 Title: Geologic Cross Section A-A', B-B'

Figure #: 5 Title: Geologic Cross Section C-C'

- Groundwater Isoconcentration Map:** For sites closing with residual groundwater contamination, this map shows the horizontal extent of all groundwater contamination exceeding a ch. NR140 Preventive Action Limit (PAL) and an Enforcement Standard (ES). Indicate the direction and date of groundwater flow, based on the most recent sampling data.

Note: This is intended to show the total area of contaminated groundwater.

Figure #: 2 Title: Groundwater Quality Map

- Groundwater Flow Direction Map:** A map that represents groundwater movement at the site. If the flow direction varies by more than 20° over the history of the site, submit 2 groundwater flow maps showing the maximum variation in flow direction.

Figure #: 1 Title: Groundwater Contour Map (6/7/12)

Figure #: Title:

TABLES (meeting the requirements of s. NR 716.15(2)(h)(3))

Tables must be no larger than 11 x 17 inches unless the table is submitted electronically. Tables must not contain shading and/or cross-hatching. The use of **BOLD** or *ITALICS* is acceptable.

- Soil Analytical Table:** A table showing remaining soil contamination with analytical results and collection dates.
Note: This is one table of results for the contaminants of concern. Contaminants of concern are those that were found during the site investigation, that remain after remediation. It may be necessary to create a new table to meet this requirement.

Table #: Title: Soil Quality Data Tables (Warzyn & Sigma data)

- Groundwater Analytical Table:** Table(s) that show the most recent analytical results and collection dates, for all monitoring wells and any potable wells for which samples have been collected.

Table #: 3 Title: Groundwater Quality Results

- Water Level Elevations:** Table(s) that show the previous four (at minimum) water level elevation measurements/dates from all monitoring wells. If present, free product is to be noted on the table.

Table #: 2 Title: Static Groundwater Elevations

IMPROPERLY ABANDONED MONITORING WELLS

For each monitoring well not properly abandoned according to requirements of s. NR 141.25 include the following documents.

Note: If the site is being listed on the GIS Registry for only an improperly abandoned monitoring well you will only need to submit the documents in this section for the GIS Registry Packet.

- Not Applicable**

- Site Location Map:** A map showing all surveyed monitoring wells with specific identification of the monitoring wells which have not been properly abandoned.

Note: If the applicable monitoring wells are distinctly identified on the Detailed Site Map this Site Location Map is not needed.

Figure #: Title:

- Well Construction Report:** Form 4440-113A for the applicable monitoring wells.

- Deed:** The most recent deed as well as legal descriptions for each property where a monitoring well was not properly abandoned.

- Notification Letter:** Copy of the notification letter to the affected property owner(s).

BRRTS #: 03-67-558530

ACTIVITY NAME: JACOBUS WEST BEND RETAIL STATION (FORMER)

NOTIFICATIONS

Source Property

Not Applicable

Letter To Current Source Property Owner: If the source property is owned by someone other than the person who is applying for case closure, include a copy of the letter notifying the current owner of the source property that case closure has been requested.

Return Receipt/Signature Confirmation: Written proof of date on which confirmation was received for notifying current source property owner.

Off-Source Property

Group the following information per individual property and label each group according to alphabetic listing on the "Impacted Off-Source Property" attachment.

Not Applicable

Letter To "Off-Source" Property Owners: Copies of all letters sent by the Responsible Party (RP) to owners of properties with groundwater exceeding an Enforcement Standard (ES), and to owners of properties that will be affected by a land use control under s. 292.12, Wis. Stats.

Note: Letters sent to off-source properties regarding residual contamination must contain standard provisions in Appendix A of ch. NR 726.

Number of "Off-Source" Letters: 2

Return Receipt/Signature Confirmation: Written proof of date on which confirmation was received for notifying any off-source property owner.

Deed of "Off-Source" Property: The most recent deed(s) as well as legal descriptions, for all affected deeded **off-source property(ies)**. This does not apply to right-of-ways.

Note: If a property has been purchased with a land contract and the purchaser has not yet received a deed, a copy of the land contract which includes the legal description shall be submitted instead of the most recent deed. If the property has been inherited, written documentation of the property transfer should be submitted along with the most recent deed.

Certified Survey Map: A copy of the certified survey map or the relevant section of the recorded plat map for those properties where the legal description in the most recent deed refers to a certified survey map or a recorded plat map. (lots on subdivided or platted property (e.g. lot 2 of xyz subdivision)).

Figure #: **Title: Off-Source A only**

Letter To "Governmental Unit/Right-Of-Way" Owners: Copies of all letters sent by the Responsible Party (RP) to a city, village, municipality, state agency or any other entity responsible for maintenance of a public street, highway, or railroad right-of-way, within or partially within the contaminated area, for contamination exceeding a groundwater Enforcement Standard (ES) and/or soil exceeding a Residual Contaminant Level (RCL) or a Site Specific Residual Contaminant Level (SSRCL).

Number of "Governmental Unit/Right-Of-Way Owner" Letters: 1

Impacted Off-Source Property Information

Form 4400-246 (R 3/08)

This fillable form is intended to provide a list of information that must be submitted for evaluation for case closure. It is to be used in conjunction with Form 4400-202, Case Closure Request (Section H). The closure of a case means that the Department has determined that no further response is required at that time based on the information that has been submitted to the Department.

NOTICE: Completion of this form is mandatory for applications for case closure pursuant to ch. 292, Wis. Stats. and ch. NR 726, Wis. Adm. Code, including cases closed under ch. NR 746 and ch. NR 726. The Department will not consider, or act upon your application, unless all applicable sections are completed on this form and the closure fee and any other applicable fees, required under ch. NR 749, Wis. Adm. Code, Table 1 are included. It is not the Department's intention to use any personally identifiable information from this form for any purpose other than reviewing closure requests and determining the need for additional response action. The Department may provide this information to requesters as required by Wisconsin's Open Records law [ss. 19.31 - 19.39, Wis. Stats.].

BRRTS #:

03-67-558530

ACTIVITY NAME: JACOBUS WEST BEND RETAIL STATION (FORMER)

ID	Off-Source Property Address	Parcel Number	WTM X	WTM Y
A	760 INDIANA AV	291_11191330020	667812	328229
B	773 INDIANA AV	291_11191330706	667894	328243
C				
D				
E				
F				
G				
H				
I				



December 10, 2013

Michael Helgeson
Jacobus Energy, Inc.
11815 W. Bradley Rd.
Milwaukee, WI 53224

Dear Mr. Helgeson:

SUBJECT: Final Case Closures with Continuing Obligations, West Bend Bulk Plant (BRRTS #0367001449), Jacobus West Bend Retail Station (Former) (BRRTS #0367558530), Jacobus West Bend Bulk Systems (Former) BRRTS #0367558564, 111 E. Decorah Rd., FID #267102220.

The Wisconsin Department of Natural Resources (WDNR) considers the above designated cases closed, with continuing obligations. No further investigation or remediation is required at this time. However, you, future property owners, and occupants of the property must comply with the continuing obligations as explained in the conditions of closure in this letter. Please read over this letter closely to ensure that you comply with all conditions and other on-going requirements. Provide this letter and any attachments listed at the end of this letter to anyone who purchases, rents or leases this property from you.

This final closure decision is based on the correspondence and data that you provided, and is issued under ch. NR 726, Wisconsin Administrative Code. The Southeast Region WDNR Closure Committee reviewed your request for closure on February 13, 2013. This Closure Committee reviews environmental remediation cases for compliance with state laws and standards to maintain consistency in the closure of these cases. A conditional closure letter pending monitoring well abandonment was issued by the WDNR on March 5th, 2013, and documentation that the conditions in that letter were met was received by the WDNR on August 19, 2013.

This property was a petroleum bulk storage facility as well as a retail gas station. Since 1992 the site has undergone various forms of remedial action for on, and offsite petroleum contamination in the soil and groundwater. Remedial actions included tank removals, soil remediation, groundwater pump-and-treat, free product removal, and soil venting. Monitored natural attenuation in groundwater went on since that time also. The conditions of this closure and continuing obligations are based on this property being used for commercial purposes. Offsite effected properties have contamination in the groundwater and include at the right-of-way of East Decorah Road; at JKA Enterprises, 760 S. Indiana Avenue; and at Good Shepherd Evangelical Lutheran Church, 777 S. Indiana Avenue.

Continuing Obligations

The continuing obligations for this site are summarized below. Further details on actions required are found in the section Closure Conditions.

- Groundwater contamination is present above ch. NR 140, Wis. Adm. Code enforcement standards.
- Residual soil contamination exists that must be properly managed should it be excavated or removed.

December 10, 2013; BRRTS #0367001449, BRRTS #0367558530, BRRTS #0367558564

- Pavement, an engineered cover or a soil barrier must be maintained to prevent infiltration over contaminated soil, and the WDNR must approve any changes to this barrier.
- Remaining soil contamination could result in vapor intrusion if future construction activities occur. Vapor control technologies will be required for occupied buildings, unless the property owner assesses the potential for vapor intrusion, and the WDNR agrees that vapor control technologies are not needed.
- Site-specific vapor exposure assumptions were used; based on commercial or industrial use. Current land or property use must be maintained to be protective. If changes to the current property use or land use are planned, an assessment must be made of whether the closure is still protective.

GIS Registry

This site will be included on the Bureau for Remediation and Redevelopment Tracking System (BRRTS on the Web) at <http://dnr.wi.gov/topic/Brownfields/rasm.html>, to provide public notice of residual contamination and of any continuing obligations. The site can also be viewed on the Remediation and Redevelopment Sites Map (RRSM), a map view, under the Geographic Information System (GIS) Registry layer, at the same web address.

WDNR approval prior to well construction or reconstruction is required for all sites shown on the GIS Registry, in accordance with s. NR 812.09 (4) (w), Wis. Adm. Code. This requirement applies to private drinking water wells and high capacity wells. To obtain approval, complete and submit Form 3300-254 to the WDNR Drinking and Groundwater program's regional water supply specialist. This form can be obtained on-line at <http://dnr.wi.gov/topic/wells/documents/3300254.pdf>.

All site information is also on file at the Southeast Regional WDNR office, at 1155 Pilgrim Road, Plymouth, Wisconsin 53073. This letter and information that was submitted with your closure request application, including any maintenance plan and maps, can be found as a PDF in BRRTS on the Web.

Closure Conditions

Compliance with the requirements of this letter is a responsibility to which you, and any subsequent property owners must adhere. WDNR staff will conduct periodic prearranged inspections to ensure that the conditions included in this letter and the attached maintenance plans are met. If these requirements are not followed, the WDNR may take enforcement action under s. 292.11, Wis. Stats. to ensure compliance with the specified requirements, limitations or other conditions related to the property.

Please send written notifications in accordance with the following requirements to Environmental Program Assistant, Remediation and Redevelopment Program, PO Box 12436, Milwaukee, WI 53212, to the attention of Victoria Stovall.

Residual Groundwater Contamination (ch. NR 140, 812, Wis. Adm. Code)

Groundwater contamination greater than enforcement standards is present both on this contaminated property and off this property, as shown on the attached map. You notified property owners of the presence of groundwater contamination. If you intend to construct a new well, or reconstruct an existing well, you'll need prior WDNR approval.

Residual Soil Contamination (ch. NR 718, chs. 500 to 536, Wis. Adm. Code or ch. 289, Wis. Stats.)

Soil contamination remains around the edges of the former remedial excavations as indicated on the attached map. If soil in the specific locations described above is excavated in the future, the property owner or right-of-

December 10, 2013; BRRTS #0367001449, BRRTS #0367558530, BRRTS #0367558564

way holder at the time of excavation must sample and analyze the excavated soil to determine if contamination remains. If sampling confirms that contamination is present, the property owner or right-of-way holder at the time of excavation will need to determine whether the material is considered solid or hazardous waste and ensure that any storage, treatment or disposal is in compliance with applicable standards and rules. Contaminated soil may be managed in accordance with ch. NR 718, Wis. Adm. Code, with prior WDNR approval.

In addition, all current and future owners and occupants of the property and right-of-way holders need to be aware that excavation of the contaminated soil may pose an inhalation or other direct contact hazard and as a result special precautions may need to be taken to prevent a direct contact health threat to people.

Cover or Barrier (s. 292.12 (2) (a), Wis. Stats., s. NR 726.15, s. NR 727.07 Wis. Adm. Code)

The pavement, building and other impervious cover that exists in the location shown on the attached map shall be maintained in compliance with the attached maintenance plan in order to minimize the infiltration of water and prevent additional groundwater contamination that would violate the groundwater quality standards in ch. NR 140, Wis. Adm. Code.

A cover or barrier for industrial land uses, or certain types of commercial land uses may not be protective if the use of the property were to change such that a residential exposure would apply. This may include, but is not limited to single or multiple family residences, a school, day care, senior center, hospital or similar settings. In addition, a cover or barrier for multi-family residential housing use may not be appropriate for use at a single family residence. The cover approved for this closure was designed to be protective for a commercial or industrial use setting. Before using the property for residential purposes, you must notify the WDNR at least 45 days before taking an action, to determine if additional response actions are warranted.

A request may be made to modify or replace a cover or barrier. The replacement or modified cover or barrier must be protective of the revised use of the property, and must be approved in writing by the WDNR prior to implementation.

The attached maintenance plan and inspection log (WDNR form 4400-305) are to be kept up-to-date and on site. Inspections shall be conducted annually in accordance with the attached maintenance plan. Submit the inspection log to the WDNR only upon request.

Vapor Mitigation or Evaluation (s. 292.12 (2), Wis. Stats., s. NR 726.15, s. NR 727.07, Wis. Adm. Code)

Vapor intrusion is the movement of vapors coming from volatile chemicals in the soil or groundwater, into buildings where people may breathe air contaminated by the vapors. Vapor mitigation systems are used to interrupt the pathway, thereby reducing or preventing vapors from moving into the building. Petroleum volatile organic contaminants remain in soil and groundwater: in soil, around the perimeter of the former remedial excavations; and in groundwater, in a plume that extends from the central portion of the property to offsite in a northeasterly direction, as shown on the attached map, at levels that may be of concern for vapor intrusion in the future, depending on construction and occupancy of a building.

- Remaining soil contamination could result in vapor intrusion if future construction activities occur. Vapor control technologies will be required for occupied buildings, unless the property owner assesses the potential for vapor intrusion, and the WDNR agrees that vapor control technologies are not needed.
- Depending on site-specific conditions, construction over contaminated soils or groundwater may result in vapor migration of contaminants into enclosed structures or migration along newly placed underground

December 10, 2013; BRRTS #0367001449, BRRTS #0367558530, BRRTS #0367558564

- utility lines. The potential for vapor inhalation and means of mitigation should be evaluated when planning any future redevelopment, and measures should be taken to ensure the continued protection of public health, safety, welfare and the environment at the site.

At this time there is a building used for commercial purposes on the property. Therefore, before a new building is constructed and/or an existing building is modified, the property owner must notify the WDNR at least 45 days before the change. Vapor control technologies are required for construction of occupied buildings unless the property owner assesses the vapor pathway and WDNR agrees that vapor control technologies are not needed.

General Wastewater Permits for Construction Related Dewatering Activities

The WDNR's Water Quality Program regulates point source discharges of contaminated water, including discharges to surface waters, storm sewers, pits, or to the ground surface. This includes discharges from construction related dewatering activities, including utility and building construction.

If you or any other person plan to conduct such activities, you or that person must contact that program, and if necessary, apply for the necessary discharge permit. Additional information regarding discharge permits is available at <http://dnr.wi.gov/topic/wastewater/GeneralPermits.html>. If residual soil or groundwater contamination is likely to affect water collected in a pit/trench that requires dewatering, a general permit for Discharge of Contaminated Groundwater from Remedial Action Operations may be needed. If water collecting in a pit/trench that requires dewatering is expected to be free of pollutants other than suspended solids and oil and grease, a general permit for Pit/Trench Dewatering may be needed.

PECFA Reimbursement

Section 101.143, Wis. Stats., requires that Petroleum Environmental Cleanup Fund Award (PECFA) claimants seeking reimbursement of interest costs, for sites with petroleum contamination, submit a final reimbursement claim within 120 days after they receive a closure letter on their site. For claims not received within 120 days of the date of this letter, interest costs after 60 days of the date of this letter will not be eligible for PECFA reimbursement. If there is equipment purchased with PECFA funds remaining at the site, contact the WDNR Project Manager to determine the method for salvaging the equipment.

Final Words

The following WDNR fact sheet, "Continuing Obligations for Environmental Protection", RR-819, was included with this letter, to help explain a property owner's responsibility for continuing obligations on their property. If this fact sheet is lost, you may obtain a copy at <http://dnr.wi.gov/files/PDF/pubs/rr/RR819.pdf>.

Please be aware that the case may be reopened pursuant to s. NR 727.13, Wis. Adm. Code, for any of the following situations:

- if additional information regarding site conditions indicates that contamination on or from the site poses a threat to public health, safety, or welfare or to the environment,
- if the property owner does not comply with the conditions of closure, with any deed restrictions applied to the property, or with a certificate of completion issued under s. 292.15, Wis. Stats, or
- a property owner fails to maintain or comply with a continuing obligation (imposed under this closure approval letter).

December 10, 2013; BRRTS #0367001449, BRRTS #0367558530, BRRTS #0367558564

The WDNR appreciates your efforts to restore the environment at this site. If you have any questions regarding this closure decision or anything outlined in this letter, please contact John Feeney at 920-893-8523, email johnm.feeney@wisconsin.gov.

Sincerely,



Frances M. Koonce, Sub-Team Supervisor
Southeast Region Remediation & Redevelopment Program
Wisconsin Department of Natural Resources

Attachments:

- remaining groundwater contamination map – Figure 2, Groundwater Quality Map (12/19/2012)
- remaining soil contamination map – Figure 2B, Soil Quality Map (12/19/2012)
- cap maintenance plan ~~(8/15/2013)~~ Dec 2012
- cap map - Figure 1, Cap Maintenance Plan Map (8/15/2013)
- Continuing Obligations for Environmental Protection, Form RR819

cc: Good Shepherd Evangelical Lutheran Church
JKA Enerprises LLC
City of West Bend
Good Shepherd Evangelical Lutheran Church
Sigma Environmental
SER Files

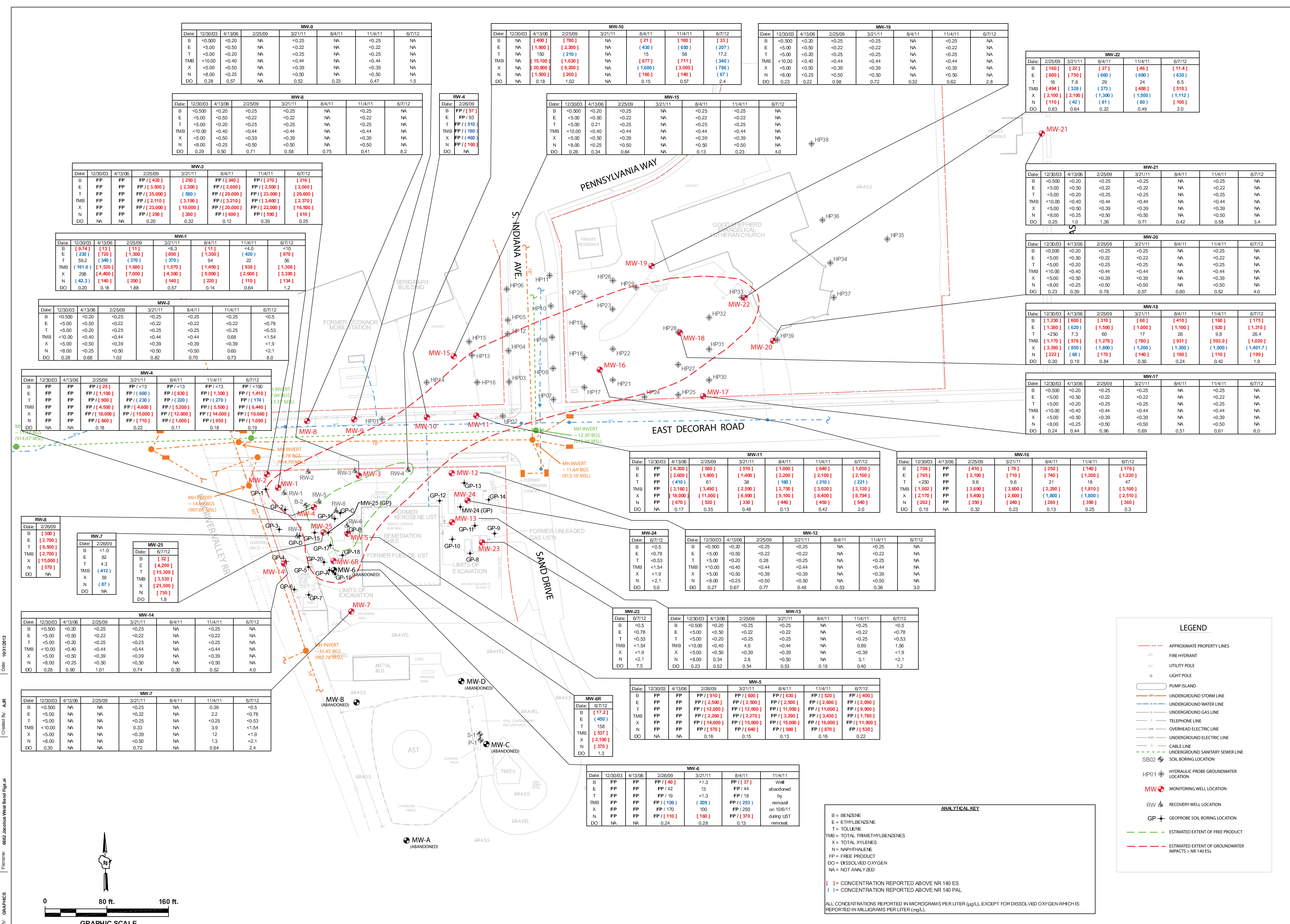

Date	12/30/03	4/13/06	2/25/09	3/21/11	8/4/11	11/4/11	6/7/12
B	<-0.500	<-0.20	NA	<-0.25	NA	<-0.25	NA
E	<-5.00	<-0.50	NA	<-0.22	NA	<-0.22	NA
T	<-5.00	<-0.20	NA	<-0.25	NA	<-0.25	NA
TMB	<-10.00	<-0.40	NA	<-0.44	NA	<-0.44	NA
X	<-5.00	<-0.50	NA	<-0.39	NA	<-0.39	NA
N	<-8.00	<-0.25	NA	<-0.50	0.23	0.47	1.5
DO	0.28	0.57	NA	0.52	0.23	0.47	1.5

Date	12/30/03	4/13/06	2/25/09	3/21/11	8/4/11	11/4/11	6/7/12
B	<-0.500	<-0.20	<-0.25	<-0.25	NA	<-0.25	NA
E	<-5.00	<-0.50	<-0.22	<-0.22	NA	<-0.22	NA
T	<-5.00	<-0.20	<-0.25	<-0.25	NA	<-0.25	NA
TMB	<-10.00	<-0.40	<-0.44	<-0.44	NA	<-0.44	NA
X	<-5.00	<-0.50	<-0.39	<-0.39	NA	<-0.39	NA
N	<-8.00	<-0.25	<-0.50	<-0.50	NA	<-0.50	NA
DO	0.29	0.50	0.71	0.58	0.75	0.41	8.2

Date	2/26/09
B	FP / [57]
E	FP / [93]
T	FP / [510]
TMB	FP / [180]
X	FP / [480]
N	FP / [190]
DO	NA

Date	12/30/03	4/13/06	2/25/09	3/21/11	8/4/11	11/4/11	6/7/12
B	NA	[400]	[780]	NA	[21]	[180]	[33]
E	<-5.00	[1,900]	[2,200]	NA	[430]	[650]	[207]
T	NA	150	[210]	NA	15	56	17.2
TMB	NA	[15,100]	[1,630]	NA	[677]	[711]	[340]
X	NA	[20,000]	[9,800]	NA	[1,600]	[3,000]	[786]
N	NA	[1,500]	[280]	NA	[180]	[67]	[2.4]
DO	NA	0.18	1.02	NA	0.15	0.57	2.4

Date	12/30/03	4/13/06	2/25/09	3/21/11	8/4/11	11/4/11	6/7/12
B	<-0.500	<-0.20	<-0.25	<-0.25	NA	<-0.25	NA
E	<-5.00	<-0.50	<-0.22	<-0.22	NA	<-0.22	NA
T	<-5.00	0.21	<-0.25	<-0.25	NA	<-0.25	NA
TMB	<-10.00	<-0.40	<-0.44	<-0.44	NA	<-0.44	NA
X	<-5.00	<-0.50	<-0.39	<-0.39	NA	<-0.39	NA
N	<-8.00	<-0.25	<-0.50	<-0.50	NA	<-0.50	NA
DO	0.26	0.34	0.64	NA	0.13	0.23	4.0

Date	12/30/03	4/13/06	2/25/09	3/21/11	8/4/11	11/4/11	6/7/12
B	<-0.500	<-0.20	<-0.25	<-0.25	NA	<-0.25	NA
E	<-5.00	<-0.50	<-0.22	<-0.22	NA	<-0.22	NA
T	<-5.00	<-0.20	<-0.25	<-0.25	NA	<-0.25	NA
TMB	<-10.00	<-0.40	<-0.44	<-0.44	NA	<-0.44	NA
X	<-5.00	<-0.50	<-0.39	<-0.39	NA	<-0.39	NA
N	<-8.00	<-0.25	<-0.50	<-0.50	NA	<-0.50	NA
DO	0.23	0.22	0.98	0.72	0.32	0.62	2.8

Date	2/25/09	3/21/11	8/4/11	11/4/11	6/7/12
B	[160]	[22]	[27]	[46]	[11.4]
E	[600]	[1750]	[600]	[600]	[600]
T	16	7.8	29	24	6.5
TMB	[494]	[328]	[373]	[488]	[510]
X	[2,100]	[2,100]	[1,300]	[1,500]	[1,112]
N	[110]	[42]	[81]	[80]	[100]
DO	0.83	0.64	0.22	0.49	2.0

Date	12/30/03	4/13/06	2/25/09	3/21/11	8/4/11	11/4/11	6/7/12
B	<-0.500	<-0.20	<-0.25	<-0.25	NA	<-0.25	NA
E	<-5.00	<-0.50	<-0.22	<-0.22	NA	<-0.22	NA
T	<-5.00	<-0.20	<-0.25	<-0.25	NA	<-0.25	NA
TMB	<-10.00	<-0.40	<-0.44	<-0.44	NA	<-0.44	NA
X	<-5.00	<-0.50	<-0.39	<-0.39	NA	<-0.39	NA
N	<-8.00	<-0.25	<-0.50	<-0.50	NA	<-0.50	NA
DO	0.25	0.0	1.36	0.71	0.42	0.58	3.4

Date	12/30/03	4/13/06	2/25/09	3/21/11	8/4/11	11/4/11	6/7/12
B	<-0.500	<-0.20	<-0.25	<-0.25	NA	<-0.25	NA
E	<-5.00	<-0.50	<-0.22	<-0.22	NA	<-0.22	NA
T	<-5.00	<-0.20	<-0.25	<-0.25	NA	<-0.25	NA
TMB	<-10.00	<-0.40	<-0.44	<-0.44	NA	<-0.44	NA
X	<-5.00	<-0.50	<-0.39	<-0.39	NA	<-0.39	NA
N	<-8.00	<-0.25	<-0.50	<-0.50	NA	<-0.50	NA
DO	0.23	0.39	0.78	0.57	0.80	0.52	4.0

Date	12/30/03	4/13/06	2/25/09	3/21/11	8/4/11	11/4/11	6/7/12
B	[1,230]	[600]	[310]	[68]	[410]	[190]	[175]
E	[1,380]	[620]	[1,500]	[1,000]	[1,100]	[920]	[1,310]
T	<250	7.3	60	17	26	9.8	26.4
TMB	[1,170]	[576]	[1,278]	[780]	[931]	[593.9]	[1,020]
X	[3,390]	[850]	[1,800]	[1,200]	[1,300]	[1,000]	[1,401.7]
N	[222]	[68]	[170]	[180]	[110]	[110]	[199]
DO	0.20	0.19	0.84	0.50	0.24	0.42	1.9

Date	12/30/03	4/13/06	2/25/09	3/21/11	8/4/11	11/4/11	6/7/12
B	<-0.500	<-0.20	<-0.25	<-0.25	NA	<-0.25	NA
E	<-5.00	<-0.50	<-0.22	<-0.22	NA	<-0.22	NA
T	<-5.00	<-0.20	<-0.25	<-0.25	NA	<-0.25	NA
TMB	<-10.00	<-0.40	<-0.44	<-0.44	NA	<-0.44	NA
X	<-5.00	<-0.50	<-0.39	<-0.39	NA	<-0.39	NA
N	<-8.00	<-0.25	<-0.50	<-0.50	NA	<-0.50	NA
DO	0.24	0.44	0.96	0.69	0.51	0.61	6.0

Date	12/30/03	4/13/06	2/25/09	3/21/11	8/4/11	11/4/11	6/7/12
B	[708]	FP	[410]	[78]	[250]	[140]	[178]
E	[765]	FP	[2,100]	[710]	[740]	[1,200]	[1,220]
T	<250	FP	9.6	9.6	21	18	47
TMB	[1,002]	FP	[3,690]	[3,600]	[2,290]	[1,810]	[3,100]
X	[2,170]	FP	[5,400]	[2,600]	[1,800]	[1,800]	[2,510]
N	[202]	FP	[350]	[240]	[260]	[330]	[360]
DO	0.19	NA	0.32	0.23	0.13	0.25	0.3

Date	12/30/03	4/13/06	2/25/09	3/21/11	8/4/11	11/4/11	6/7/12
B	FP	[4,200]	[580]	[510]	[1,000]	[1,690]	[1,690]
E	FP	[2,600]	[1,800]	[1,400]	[2,200]	[2,100]	[2,100]
T	FP	[410]	61	38	[180]	[210]	[221]
TMB	FP	[3,160]	[3,490]	[2,590]	[2,750]	[3,020]	[3,120]
X	FP	[18,000]	[11,000]	[6,900]	[9,100]	[8,400]	[8,794]
N	FP	[670]	[520]	[330]	[440]	[450]	[540]
DO	NA	0.17	0.35	0.48	0.13	0.42	2.0

Date	12/30/03	4/13/06	2/25/09	3/21/11	8/4/11	11/4/11	6/7/12
B	<-0.500	<-0.20	<-0.25	<-0.25	NA	<-0.25	NA
E	<-5.00	<-0.50	<-0.22	<-0.22	NA	<-0.22	NA
T	<-5.00	<-0.20	<-0.25	<-0.25	NA	<-0.25	NA
TMB	<-10.00	<-0.40	<-0.44	<-0.44	NA	<-0.44	NA
X	<-5.00	<-0.50	<-0.39	<-0.39	NA	<-0.39	NA
N	<-8.00	<-0.25	<-0.50	<-0.50	NA	<-0.50	NA
DO	0.27	0.67	0.77	0.48	0.53	0.36	3.0

Date	12/30/03	4/13/06	2/25/09	3/21/11	8/4/11	11/4/11	6/7/12
B	<-0.5	<-0.78	<-0.53	<-0.53	<-0.53	<-0.53	<-0.53
E	<-5.00	<-0.20	<-0.25	<-0.25	NA	<-0.25	NA
T	<-5.00	<-0.20	<-0.25	<-0.25	NA	<-0.25	NA
TMB	<-1.54	<-1.54	<-1.54	<-1.54	NA	<-1.54	NA
X	<-1.9	<-1.9	<-1.9	<-1.9	NA	<-1.9	NA
N	<-2.1	<-2.1	<-2.1	<-2.1	NA	<-2.1	NA
DO	7.5	7.5	7.5	7.5	7.5	7.5	7.5

Date	12/30/03	4/13/06	2/25/09	3/21/11	8/4/11	11/4/11	6/7/12
B	<-0.500	<-0.20	<-0.25	<-0.25	NA	<-0.25	NA
E	<-5.00	<-0.50	<-0.22	<-0.22	NA	<-0.22	NA
T	<-5.00	<-0.20	<-0.25	<-0.25	NA	<-0.25	NA
TMB	<-10.00	<-0.40	<-0.44	<-0.44	NA	<-0.44	NA
X	<-5.00	<-0.50	<-0.39	<-0.39	NA	<-0.39	NA
N	<-8.00	<-0.25	<-0.50	<-0.50	NA	<-0.50	NA
DO	0.23	0.52	0.54	0.53	0.18	0.40	1.2

Date	12/30/03	4/13/06	2/25/09	3/21/11	8/4/11	11/4/11	6/7/12
B	FP	FP	FP	FP	FP	FP	FP
E	FP	FP	FP	FP	FP	FP	FP
T	FP	FP	FP	FP	FP	FP	FP
TMB	FP	FP	FP	FP	FP	FP	FP
X	FP	FP	FP	FP	FP	FP	FP
N	FP	FP	FP	FP	FP	FP	FP
DO	NA	NA	0.16	0.15	0.13	0.16	0.22

Date	12/30/03	4/13/06	2/25/09	3/21/11
------	----------	---------	---------	---------

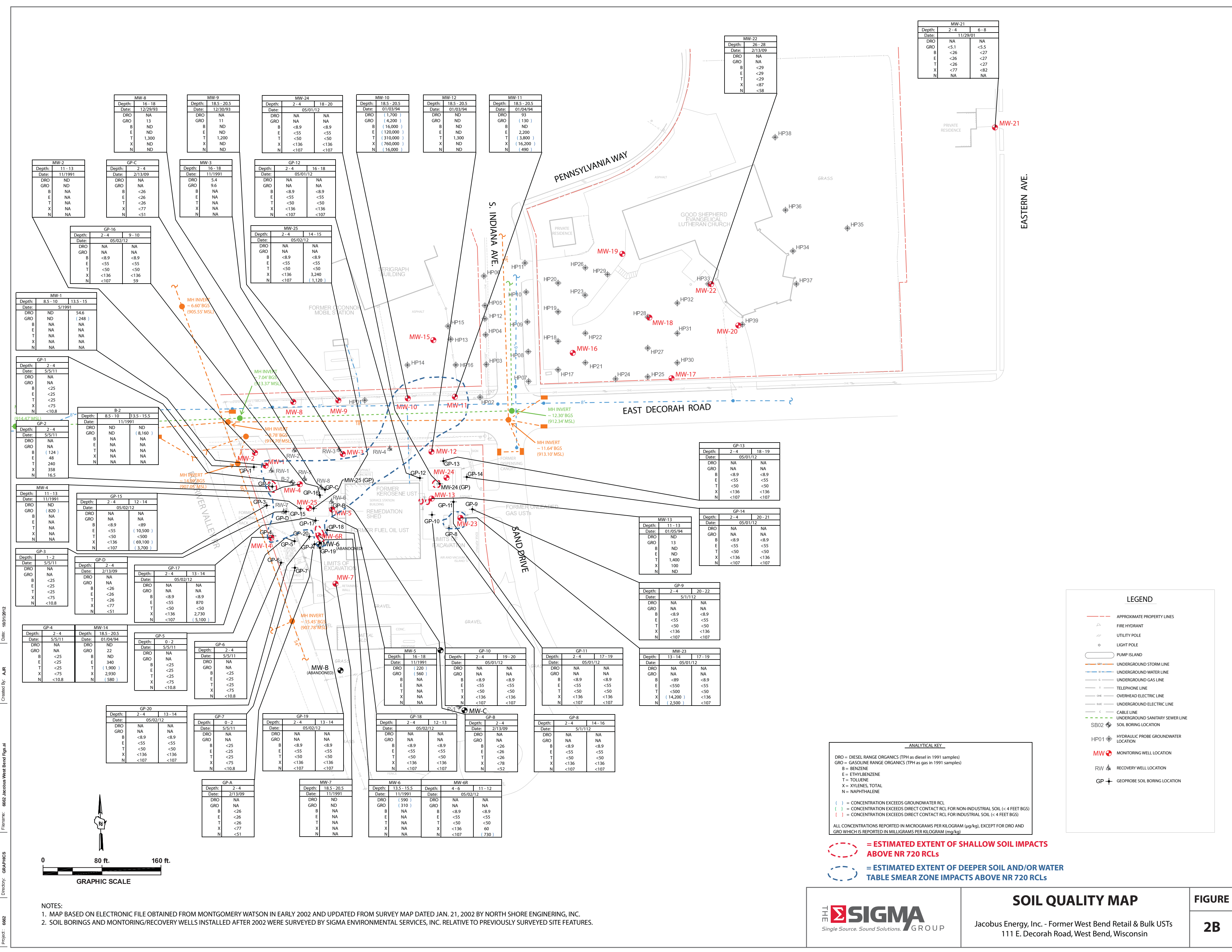

MW-21		
Depth:	2 - 4	6 - 8
Date:	11/29/01	NA
DRO	NA	NA
GRO	<5.1	<5.5
B	<26	<27
E	<26	<27
T	<26	<27
X	<77	<82
N	NA	NA

MW-22		
Depth:	2 - 4	18 - 19
Date:	2/13/09	NA
DRO	NA	NA
GRO	(4,200)	NA
B	(16,000)	NA
E	(120,000)	NA
T	(3,800)	NA
X	(760,000)	NA
N	(16,200)	NA

GP-13		
Depth:	2 - 4	18 - 19
Date:	05/01/12	NA
DRO	NA	NA
GRO	NA	NA
B	<8.9	<8.9
E	<55	<55
T	<50	<50
X	<136	<136
N	<107	<107

GP-14		
Depth:	2 - 4	20 - 21
Date:	05/01/12	NA
DRO	NA	NA
GRO	NA	NA
B	<8.9	<8.9
E	<55	<55
T	<50	<50
X	<136	<136
N	<107	<107

GP-9		
Depth:	2 - 4	20 - 22
Date:	5/1/12	NA
DRO	NA	NA
GRO	NA	NA
B	<8.9	<8.9
E	<55	<55
T	<50	<50
X	<136	<136
N	<107	<107

MW-23		
Depth:	13 - 14	17 - 19
Date:	05/01/12	NA
DRO	NA	NA
GRO	NA	NA
B	<8.9	<8.9
E	<55	<55
T	<50	<50
X	(14,200)	<136
N	(2,500)	<107

GP-10		
Depth:	2 - 4	19 - 20
Date:	05/01/12	NA
DRO	NA	NA
GRO	NA	NA
B	<8.9	<8.9
E	<55	<55
T	<50	<50
X	<136	<136
N	<107	<107

GP-8		
Depth:	2 - 4	14 - 16
Date:	5/1/12	NA
DRO	NA	NA
GRO	NA	NA
B	<8.9	<8.9
E	<55	<55
T	<50	<50
X	<136	<136
N	<107	<107

LEGEND

- APPROXIMATE PROPERTY LINES
- ▲ FIRE HYDRANT
- UTILITY POLE
- LIGHT POLE
- PUMP ISLAND
- UNDERGROUND STORM LINE
- UNDERGROUND WATER LINE
- UNDERGROUND GAS LINE
- TELEPHONE LINE
- OVERHEAD ELECTRIC LINE
- UNDERGROUND ELECTRIC LINE
- CABLE LINE
- UNDERGROUND SANITARY SEWER LINE
- SB02 SOIL BORING LOCATION
- HP01 HYDRAULIC PROBE GROUNDWATER LOCATION
- MW MONITORING WELL LOCATION
- RW RECOVERY WELL LOCATION
- GP GEOPROBE SOIL BORING LOCATION

ANALYTICAL KEY

DRO = DIESEL RANGE ORGANICS (TPH as diesel in 1991 samples)
 GRO = GASOLINE RANGE ORGANICS (TPH as gas in 1991 samples)
 B = BENZENE
 E = ETHYLBENZENE
 T = TOLUENE
 X = XYLENES, TOTAL
 N = NAPHTHALENE

() = CONCENTRATION EXCEEDS GROUNDWATER RCL
 () = CONCENTRATION EXCEEDS DIRECT CONTACT RCL FOR NON-INDUSTRIAL SOIL (< 4 FEET BGS)
 () = CONCENTRATION EXCEEDS DIRECT CONTACT RCL FOR INDUSTRIAL SOIL (< 4 FEET BGS)

ALL CONCENTRATIONS REPORTED IN MICROGRAMS PER KILOGRAM (µg/kg), EXCEPT FOR DRO AND GRO WHICH IS REPORTED IN MILLIGRAMS PER KILOGRAM (mg/kg)

--- ESTIMATED EXTENT OF SHALLOW SOIL IMPACTS ABOVE NR 720 RCLS

--- ESTIMATED EXTENT OF DEEPER SOIL AND/OR WATER TABLE SMEAR ZONE IMPACTS ABOVE NR 720 RCLS

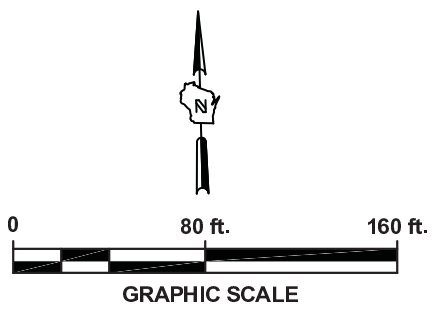

NOTES:
 1. MAP BASED ON ELECTRONIC FILE OBTAINED FROM MONTGOMERY WATSON IN EARLY 2002 AND UPDATED FROM SURVEY MAP DATED JAN. 21, 2002 BY NORTH SHORE ENGINEERING, INC.
 2. SOIL BORINGS AND MONITORING/RECOVERY WELLS INSTALLED AFTER 2002 WERE SURVEYED BY SIGMA ENVIRONMENTAL SERVICES, INC. RELATIVE TO PREVIOUSLY SURVEYED SITE FEATURES.

Single Source. Sound Solutions.

SOIL QUALITY MAP

Jacobus Energy, Inc. - Former West Bend Retail & Bulk USTs
 111 E. Decorah Road, West Bend, Wisconsin

FIGURE

2B

CAP MAINTENANCE PLAN
111 E. DECORAH ROAD, WEST BEND, WISCONSIN
WDNR BRRTS #03-67-001449 (WEST BEND BULK PLANT [FORMER])
WDNR BRRTS #03-67-558530 (JACOBUS WEST BEND RETAIL STATION [FORMER])
WDNR BRRTS #03-67-558564 (JACOBUS WEST BEND BULK SYSTEM [FORMER])
DECEMBER 2012

This Cap Maintenance Plan ("Plan") has been prepared in accordance with s. NR 724.13(2) and is designed to prevent direct contact with residual petroleum volatile organic compound (PVOC) soil impacts and to prevent precipitation infiltration into the subsurface. The PVOC impacted soils, which are as shallow as 2 feet below ground surface (bgs) and extend to a depth of approximately 20 feet bgs (water table smear zone), are located in multiple areas of the site as shown on the attached "Cap Maintenance Plan Map".

More site-specific information about this project may be found at:

- The case file in the WDNR Southeast Region office;
- BRRTS on the Web (WDNR's internet-based database of contaminated sites): <http://dnr.wi.gov/botw/SetUpBasicSearchForm.do>;
- GIS Registry PDF file: <http://dnrmaps.wisconsin.gov/imf/imf.jsp?site=brrts2>; and
- The WDNR project manager for Washington County.

The normal operation of the asphalt and concrete pavements, as well as the concrete floor slab of the on-site building, will serve as a direct contact barrier between site soils and typical, non-invasive users of the property. Additionally, these barriers will also prevent precipitation infiltration and thus minimize the mass flux from the soil phase into the groundwater phase. The engineered barriers will function as intended unless disturbed.

Disturbance Management

The property owner shall take the following steps to assure that uncontrolled disturbances of the engineered barrier do not occur:

- WDNR's case closure documents and GIS Registry will establish future land use, development, and/or management restrictions of the site. This Plan will be incorporated into the case closure documents and/or GIS Registry, which will together identify the environmental impacts, the nature of the engineered barriers, the requirements regarding the management of impacted soils, and the availability of this Plan.
- A copy of this Plan will be available from the property owner to all interested parties.

- A copy of this Plan will be provided to all private utilities seeking easements for the purpose of installing facilities on the property.
- A copy of this Plan will be provided to all contractors and repair workers, including utility and landscaping services, during construction and repairs on the property.
- On-site personnel employed by current or future business operators will be made familiar with the contents and restriction requirements of this Plan.

Inspections of Engineered Barrier

Inspections will be required to assure that the engineered barrier is functioning as planned:

- The property owner or designated representative shall perform annual inspections of the engineered barrier system. The inspections will be performed to evaluate damage due to settling, wear, age, and other factors. Any areas where soils have become or likely to become exposed will be documented.
- As necessary, the engineered barriers will be repaired as soon as practical to maintain integrity. Repairs may include, but are not limited to, the following:
 - Patching, resurfacing, or replacing asphalt and/or concrete pavement where it has cracked or otherwise broken and would allow direct contact with underlying soil or precipitation ponding/infiltration; and
 - Patching breaches in the concrete floor slab of the building.
- An inspection log will be maintained to record the engineered barrier conditions, any disturbances of the engineered barrier, and the steps that have been taken to maintain the integrity of the engineered barrier. The inspection log will be made available for inspection by representatives of the WDNR upon reasonable prior request. The on-site inspection log will be maintained as long as inspection and maintenance of the engineered barriers are required.

Planned Breaches of Engineered Barriers

In the event an engineered barrier is breached, the following precautions shall be taken:

- Property owner will make soil data available to workers who penetrate the engineered barrier to allow for appropriate health and safety planning.
- The excavation zone and any soils excavated will be secured from public access until the cap is restored. The excavated soil will be placed on an impervious surface (e.g., existing concrete or asphalt pavement or plastic) and covered with plastic. Excavated soil shall be sampled and disposed of at a licensed landfill facility in accordance with applicable solid and/or hazardous waste rules and regulations,

unless the WDNR or its successor agency grants approval to replace the soil into the same excavation.

- The engineered barrier will be restored to meet original conditions. This work, including the proper disposal of excess soils, should be completed as soon as practical. Any replacement barrier will be subject to the same inspection and maintenance guidelines as outlined in this Plan unless otherwise indicated by the WDNR or its successor agency.
- Details of the engineered barrier breach, the handling of excavated soils, individuals responsible for the work, and the restoration of the engineered barrier shall be recorded in the engineered barrier maintenance log. The maintenance log will be available for inspection, by representatives of the WDNR upon reasonable prior request. An example inspection log page is included with this Plan.

Prohibition of Activities and Notification to WDNR

The following activities are prohibited on any portion of the site where asphalt pavement and/or building floor slab are required on the attached "Cap Maintenance Plan Map", unless prior written approval has been obtained from the WDNR or its successor agency: (1) removal of the existing barriers, (2) replacement with another barrier, (3) excavating or grading of the land surface, (4) filling on capped or paved areas, (5) plowing for agricultural cultivation, (6) construction or placement of a building or other structure.

Amendments

This Plan may be amended or withdrawn upon written approval from the WDNR or its successor agency.

Contact Information (as of December 2012)

- Site Owner and Responsible Party:
Jacobus Energy, Inc.
11815 W. Bradley Road
Milwaukee, WI 53224
Telephone: (414) 577-0217
Contact: Mr. Mike Helgesen
Email: MichaelHelgesen@jacobusenergy.com

Signature: _____

- For environmental consultant information contact:

Sigma Environmental Services, Inc.
1300 West Canal Street
Milwaukee, WI 53233
Telephone: (414) 643-4200
Email: aroder@thesimgagroup.com
Contact: Mr. Adam Roder

- For Wisconsin Department of Natural Resources information contact:

Wisconsin Department of Natural Resources
Plymouth Service Center
1155 Pilgrim Parkway
P.O. Box 408
Plymouth, WI 53073-0408
Telephone: (920) 892-8756 x 3023
Email: John.Feeney@wisconsin.gov
Contact: Mr. John Feeney

CAP INSPECTION LOG
111 E. DECORAH ROAD, WEST BEND, WISCONSIN
WDNR BRRTS #03-67-001449 (WEST BEND BULK PLANT [FORMER])
WDNR BRRTS #03-67-558530 (JACOBUS WEST BEND RETAIL STATION [FORMER])
WDNR BRRTS #03-67-558564 (JACOBUS WEST BEND BULK SYSTEM [FORMER])
DECEMBER 2012

Inspection Date	Inspector	Condition of Engineered Barrier	Recommendations	Have recommendations from previous inspection been implemented?

Project: 6662 | Directory: Graphics | Filename: 6662 Aerial Site Plan Map.ai | Created By: AJR | Date: 8/14/2013



W Decorah Rd

E Decorah Rd

S Inc

Sand Dr

LIMITS OF ENGINEERED CAP

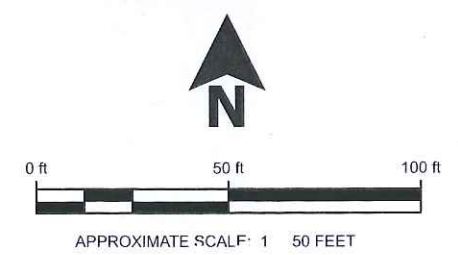

NOTES:
1. Aerial photograph from <http://atlas.freshlightstudios.com>.



CAP MAINTENANCE PLAN MAP

JACOBUS RETAIL GASOLINE STATION & BULK FACILITY
111 E. DECORAH ROAD, WEST BEND, WISCONSIN

FIGURE
1

State of Wisconsin
DEPARTMENT OF NATURAL
RESOURCES
Plymouth Service Center
1155 N Pilgrim Road
Plymouth WI 53073

Scott Walker, Governor
Cathy Stepp, Secretary
Telephone 608-266-2621
Toll Free 1-888-936-7463



March 5, 2013

Michael Helgeson
Jacobus Energy, Inc.
11815 W. Bradley Rd.
Milwaukee, WI 53224

Dear Mr. Helgeson:

SUBJECT: Conditional Case Closure pending well abandonment, Jacobus Energy Inc., 111 E. Decorah Road, West Bend, file reference file reference BRRTS #0367001449, BRRTS #0367558530, BRRTS #0367558564, FID #267102220.

The Department of Natural Resources reviewed your case closure request recently and has determined that well abandonment is appropriate at this time. Please have your consultant abandon the monitoring wells at the site and send the well abandonment documentation to me. When I receive the documents the department will issue a final closure letter for this site. Note that if the wells are out of use for a long period of time without being abandoned, the department will re-open this case.

Also please extend the cap map to include the portion of the property where soil borings GP-2 and GP-4 were located. Submit a modified map to me with your well abandonment forms.

If you have any questions about this letter, please call me at 920-892-8756, extension 3023.

Sincerely,

John Feeney
Wisconsin Department of natural Resources

Cc: Sigma
SER File

DOCUMENT NO

STATE BAR OF WISCONSIN FORM 1 - 1988

THIS SPACE RESERVED FOR RECORDING DATA

534531

1003 FALL 33

This Deed, made between The Jacobus Company, a Wisconsin corporation, f/k/a Hillside Realty Company, a Wisconsin corporation

and Jacobus Petroleum Products, Inc., a Wisconsin corporation

Grantor,

Grantee,

Witnesseth, That the said Grantor, for a valuable consideration the receipt of which is hereby acknowledged conveys to Grantee the following described real estate in Washington County, State of Wisconsin:

RETURN TO Patricia Budke Godfrey & Kahn, S.C. 780 North Water Street Milwaukee, WI 53202

Tax Parcel No: 013 1182 010

Oct 6 9 03 AM '88

See attached Exhibit A.

TRANSFER FEE 218.00

This is not homestead property. (is not)

Together with all and singular the hereditaments and appurtenances thereunto belonging; And Grantor warrants that the title is good, indefeasible in fee simple and free and clear of encumbrances except municipal and zoning ordinances, recorded easements for public utilities, recorded building and use restrictions and covenants, general taxes levied in 1988 and subsequent years and will warrant and defend the same.

Dated this 8th day of February, 1988

(SEAL), By: C. D. Jacobus, president (SEAL) Attest: F. J. Regenness, secretary (SEAL)

AUTHENTICATION

Signature(s) of C. D. Jacobus... authenticated this 8th day of February, 1988... TITLE: MEMBER STATE BAR OF WISCONSIN (If not, authorized by § 706.06, Wis. Stats.)

ACKNOWLEDGMENT

STATE OF WISCONSIN County. Personally came before me this ... day of ... 19... the above named ... to me known to be the person who executed the foregoing instrument and acknowledge the same. Notary Public County, Wis. My Commission is permanent. (If not, state expiration date: ... 19...)

THIS INSTRUMENT WAS DRAFTED BY

Patricia Budke Godfrey & Kahn, S.C.

(Signatures may be authenticated or acknowledged. Both are not necessary.)

*Names of persons signed in any capacity shall be typed or printed below their signatures.

EXHIBIT A

That part of the Northeast Quarter of the NORTH-WEST Quarter (NE $\frac{1}{4}$ NW $\frac{1}{4}$) of Section Twenty-four (24), Township Eleven (11) North, Range Nineteen (19) East, City of West Bend, Washington County, Wisconsin, described as follows, viz:

Commencing at the intersection of the north line of Section 24 with the easterly right-of-way line of the Chicago & Northwestern Railroad; thence Southeasterly along said easterly right-of-way line, 1000 feet; thence North 69 degrees 30 minutes East, 499.22 feet to a point on the centerline of Indiana Avenue; thence Northwest-erly along said centerline on a curve to the left, said curve having a radius of 1146.28 feet, the chord of which bears North 39 degrees 36 minutes West, a distance of 76.18 feet; thence North 41 degrees 30 minutes West along said centerline, 406.90 feet; thence on a curve to the right along said centerline, said curve having a radius of 399.93 feet, the chord of which bears North 20 degrees 49 minutes 30 seconds West, a distance of 282.41 feet; thence North 00 degrees 09 minutes West along said centerline, 140.94 feet to a point on the north line of Section 24, said point being the intersection of the centerline of Indiana Avenue as platted in Riverview Heights Sub-division, (a subdivision in the City of West Bend), with the north line of Section 24; thence West along said north line to the place of beginning.

EXCEPTING THEREFROM that part thereof hereto-fore conveyed to City of West Bend, for road purposes, as described by deed recorded in Washington County Registry in Volume 211 of Deeds on page 423, Document No. 233821.

PLAT OF SURVEY
FOR: JACOBUS/QUICKFLASH CO.
SCALE: 1" = 40'-0"

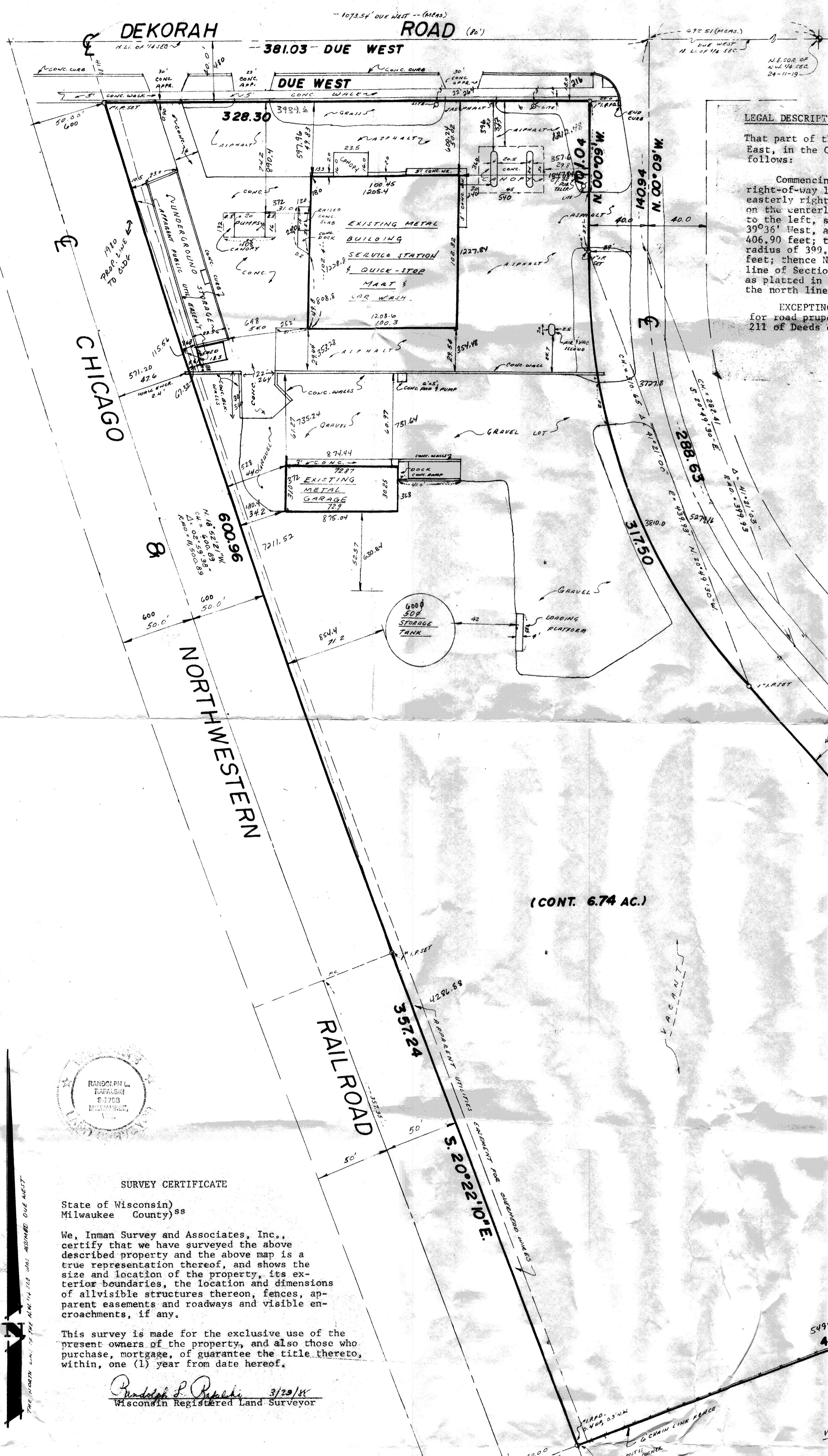

LEGAL DESCRIPTION (DEEDED)

That part of the Northeast 1/4 of the Northwest 1/4 of Section 24, Town 11 North, Range 19 East, in the City of West Bend, Washington County, Wisconsin, bounded and described as follows:

Commencing at the intersection of the north line of Section 24 with the easterly right-of-way line of the Chicago & Northwestern Railroad; thence Southeasterly along said easterly right-of-way line, 1,900 feet; thence North 69°30' East, 499.22 feet to a point on the centerline of Indiana Avenue; thence Northwesterly along said centerline on a curve to the left, said curve having a radius of 1146.28 feet, the chord of which bears North 39°36' West, a distance of 76.18 feet; thence North 41°30' West along said centerline, 406.90 feet; thence on a curve to the right along said centerline, said curve having a radius of 399.93 feet, the chord of which bears North 20°49'30" West, a distance of 282.41 feet; thence North 00°09' West along said centerline, 140.94 feet to a point on the north line of Section 24, said point being the intersection of the centerline of Indiana Avenue as platted in Riverview Heights Subdivision, (a subdivision in the City of West Bend), with the north line of Section 24; thence West along said north line to the place of beginning.

EXCEPTING THEREFROM that part thereof heretofore conveyed to the City of West Bend, for road purposes, as described by deed recorded in Washington County Registry in Volume 211 of Deeds on page 423, Document No. 23381.

SUGGESTED LEGAL DESCRIPTION

All that part of the Northeast 1/4 of the Northwest 1/4 of Section 24, Town 11 North, Range 19 East, in the City of West Bend, Washington County, Wisconsin, bounded and described as follows:

Commencing at the Northwest corner of said 1/4 section; thence Due West along the north line of said 1/4 section, 692.51 feet to a point on the centerline of Indiana Avenue and the point of beginning of the lands to be described; thence continuing Due West, along the north line of said 1/4 section, 381.03 feet to a point; said point being the easterly right-of-way line of the Chicago and Northwestern Railroad; thence southeasterly 600.96 feet along the arc of a curve, center lying to the east, whose radius is 11,500.89 feet along a chord bearing S. 18°52'21"E., a chord distance of 600.89 feet to a point; thence continuing along said easterly right-of-way line S. 20°22'10"E., 357.24 feet to a point; thence N. 69°30'E., 500.10 feet to a point on the centerline of Indiana Avenue; thence northwesterly 76.18 feet along the arc of a curve, center lying to the southwest, whose radius is 1146.28 feet along a chord which bears N. 39°36'W., 76.18 feet to a point; thence continuing along the centerline of Indiana Avenue N. 41°30'W., 406.90 feet to a point of curve, thence northwesterly 282.63 feet along the arc of a curve, center lying to the northeast, with a radius of 399.93 feet along a chord bearing N. 20°49'30"W., 282.41 feet to a point, thence continuing along said centerline of said Indiana Avenue, N. 00°09'W., 140.94 feet to a point on the north line of said 1/4 section and the point of beginning, EXCEPTING THEREFROM the north 40 feet and the easterly 40 feet for public street purposes.



SURVEY CERTIFICATE

State of Wisconsin)
 Milwaukee County) ss

We, Inman Survey and Associates, Inc., certify that we have surveyed the above described property and the above map is a true representation thereof, and shows the size and location of the property, its exterior boundaries, the location and dimensions of all visible structures thereon, fences, apparent easements and roadways and visible encroachments, if any.

This survey is made for the exclusive use of the present owners of the property, and also those who purchase, mortgage, or guarantee the title thereto, within, one (1) year from date hereof.

Randolph L. Rafaski 3/20/88
 Wisconsin Registered Land Surveyor

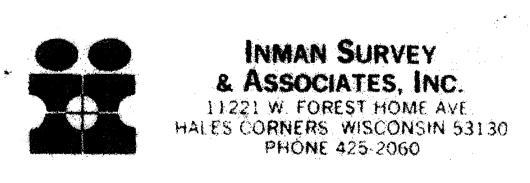

JOB NO. 15148
 DATED: 3/22/88



Information for Parcel 1119.242.0011, Tax Year 2013

Property Information	
Tax Year 2013	Parcel Number 1119.242.0011
Tax Status Taxable	Property Class B-B-Commercial
Tax Code TC1 - Tax Code #1	Neighborhood 710 - 710
Site Address 103 E DECORAH RD	Legal Description NE 1/4 - NW 1/4 SEC 24-11-19 DOC #534531
Owner Name and Address JACOBUS PETROLEUM PRD PO BOX 13009 MILWAUKEE, WI 53213-0009	Mailing Name and Address JACOBUS PETROLEUM PRD PO BOX 13009 MILWAUKEE, WI 53213-0009

Assessments			
Assessment Period	Land	Building	Total
Prior Year Value	439,700	267,400	707,100

Sales History						
Year	Document #	Sale Type	Sale Date	Sold To	Sold By	Price

Zoning	
Classification Gen Business/Wrhsg District	Special Use? No

Permits				
Permit #	Type	Application Date	Description	Construction Value
20112420011	MISCELLANEOUS			\$0.00

Structures (1 of 1)					
Style	Property Use	Total Living Area (sq. ft.)	Above Grade (sq. ft.)	Year Built	Age
JACOBUS-STORAGE/OFFICE/SALES					
Distribution Warehouse		100.00	Base Cost		10200.00
Canopies		416.00	Canopies		1350.00
PE.-Metal Sandwich Panels		10200.00	Space Heater		7242.00
Complete HVAC		2958.00			
SHED					
Material Storage Shed		100.00	Base Cost		216.00
Adobe Block		216.00			
Storage Garage (A)					
Storage Garage		100.00	Base Cost		2160.00
Exterior Walls		2160.00	Heating and Cooling		2160.00
Storage Garage (B)					
Storage Garage		100.00	Base Cost		312.00
Heating and Cooling		312.00	Concrete Block		312.00

Images

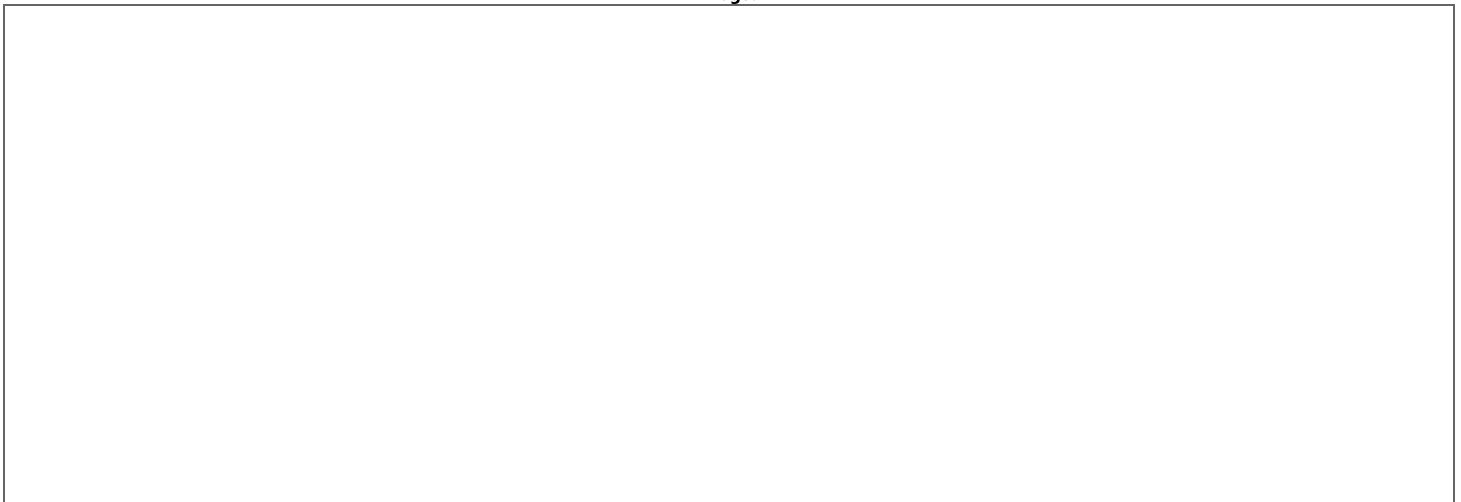

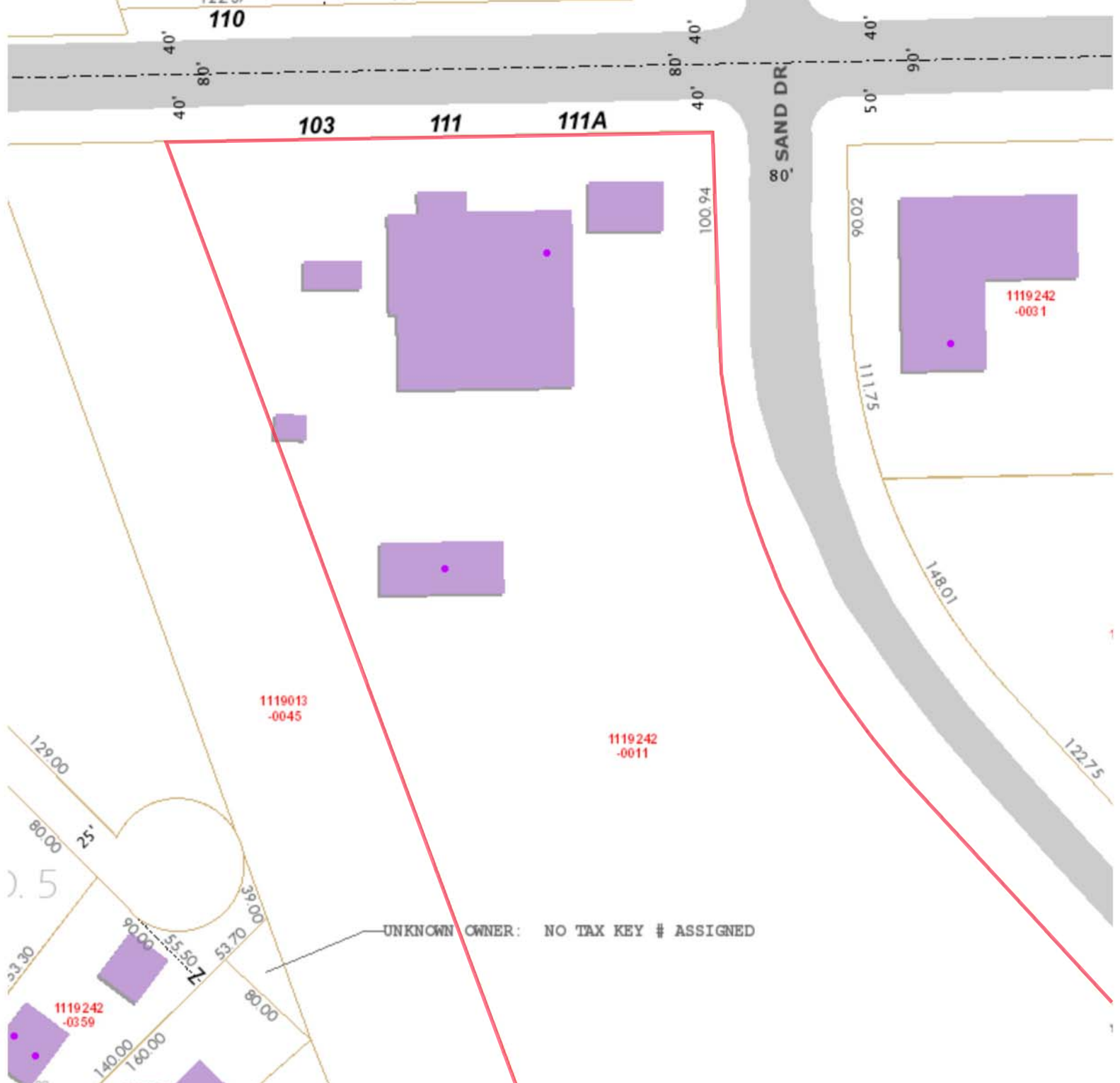

Map Generated from GIS



GIS Registry Packet

111 E. Decorah Road, West Bend, WI

BRRTS #03-67-001449 (West Bend Bulk Plant [Former])

BRRTS #03-67-558530 (Jacobus West Bend Retail Station [Former])

BRRTS #03-67-558564 (Jacobus West Bend Bulk System [Former])

STATEMENT BY RESPONSIBLE PARTY

Jacobus Energy, Inc., the responsible party for the property located at 111 E. Decorah Road, West Bend, Wisconsin states that the legal descriptions provided to the Wisconsin Department of Natural Resources in this case closure request and Geographic Information System (GIS) Registry packet for WDNR BRRTS #03-67-00144, 03-67-558530, and 03-67-558564 are complete and accurate to the best of our knowledge.

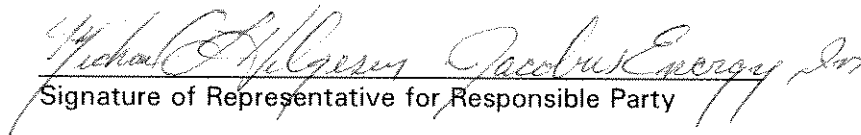
Signature of Representative for Responsible Party

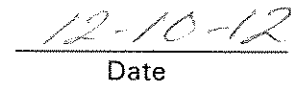
Date

Date: 6/23/11

Created By: AJR

Filename: 12805 Site Location Map.ai

Directory: 060 Graphics

Project: 12805

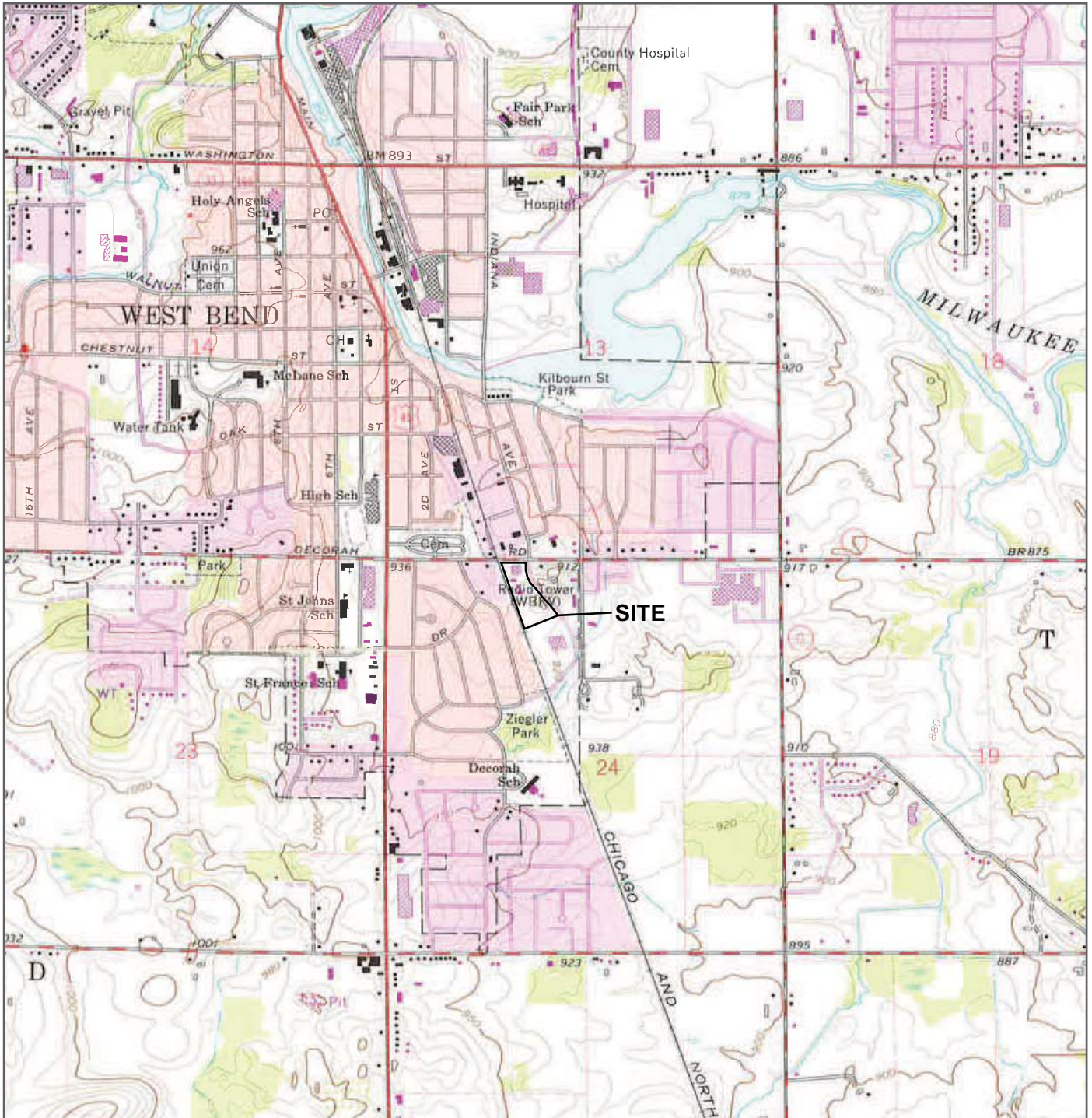

SCALE: 1" = 2,000 FEET

Located in the Northeast 1/4 of the Northwest 1/4 of Section 24, T11N, R19E
 USGS West Bend Quadrangle (1959, photorevised 1971 and 1976)
 7.5 minute, 1 : 24,000 Topographic Map Collection



SITE LOCATION MAP

JACOBUS RETAIL GASOLINE STATION
 111 E. DECORAH ROAD, WEST BEND, WISCONSIN

FIGURE

1

Project: 6682
 Directory: GRAPHICS
 Filename: 6682_Jacobus West Bend Fig1.dwg
 Created By: A.R.
 Date: 10/31/2012



LEGEND	
	APPROXIMATE PROPERTY LINES
	FIRE HYDRANT
	UTILITY POLE
	LIGHT POLE
	PUMP ISLAND
	UNDERGROUND STORM LINE
	UNDERGROUND WATER LINE
	UNDERGROUND GAS LINE
	TELEPHONE LINE
	OVERHEAD ELECTRIC LINE
	UNDERGROUND ELECTRIC LINE
	CABLE LINE
	UNDERGROUND SANITARY SEWER LINE
	SOIL BORING LOCATION
	HP01 HYDRAULIC PROBE GROUNDWATER LOCATION
	MW MONITORING WELL LOCATION
	RW RECOVERY WELL LOCATION
	GP GEOPROBE SOIL BORING LOCATION

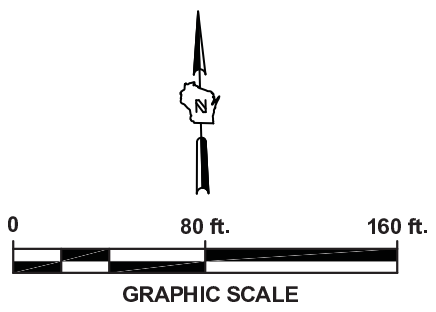

NOTES:
 1. MAP BASED ON ELECTRONIC FILE OBTAINED FROM MONTGOMERY WATSON IN EARLY 2002 AND UPDATED FROM SURVEY MAP DATED JAN. 21, 2002 BY NORTH SHORE ENGINEERING, INC.
 2. SOIL BORINGS AND MONITORING/RECOVERY WELLS INSTALLED AFTER 2002 WERE SURVEYED BY SIGMA ENVIRONMENTAL SERVICES, INC. RELATIVE TO PREVIOUSLY SURVEYED SITE FEATURES.

 THE SIGMA GROUP Single Source. Sound Solutions.	SITE PLAN MAP Jacobus Energy, Inc. - Former West Bend Retail & Bulk USTs 111 E. Decorah Road, West Bend, Wisconsin	FIGURE 1
--	---	---------------------------

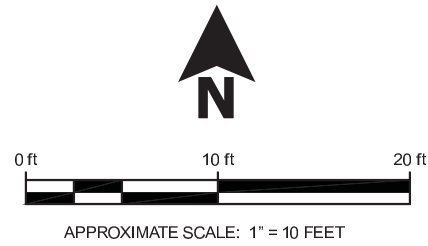

ANALYTICAL KEY	
DRO	= DIESEL RANGE ORGANICS (TPH as diesel in 1991 samples)
GRO	= GASOLINE RANGE ORGANICS (TPH as gas in 1991 samples)
B	= BENZENE
E	= ETHYLBENZENE
T	= TOLUENE
X	= XYLENES, TOTAL
N	= NAPHTHALENE
()	= CONCENTRATION EXCEEDS GROUNDWATER RCL
{ }	= CONCENTRATION EXCEEDS DIRECT CONTACT RCL FOR NON-INDUSTRIAL SOIL (< 4 FEET BGS)
[]	= CONCENTRATION EXCEEDS DIRECT CONTACT RCL FOR INDUSTRIAL SOIL (< 4 FEET BGS)
ALL CONCENTRATIONS REPORTED IN MICROGRAMS PER KILOGRAM (µg/kg), EXCEPT FOR DRO AND GRO WHICH IS REPORTED IN MILLIGRAMS PER KILOGRAM (mg/kg)	

PFO-9	
Depth:	2
Date:	10/06/11
DRO	16.6
GRO	NA
B	<25
E	<25
T	<25
X	<75
N	<25

APPROXIMATE LIMITS OF EXCAVATION DURING UST & PIPING REMOVAL

SWFO-6	
Depth:	10
Date:	10/06/11
DRO	(663)
GRO	NA
B	<25
E	47
T	44
X	181
N	(1,120)

SWFO-1	
Depth:	10
Date:	10/06/11
DRO	32.9
GRO	NA
B	<25
E	<25
T	<25
X	<75
N	<25

BFO-7	
Depth:	13
Date:	10/06/11
DRO	(11,200)
GRO	NA
B	<25
E	1,050
T	314
X	3,340
N	(14,500)

SWFO-2	
Depth:	10
Date:	10/06/11
DRO	33.3
GRO	NA
B	<25
E	<25
T	<25
X	<75
N	<25

SWFO-3	
Depth:	10
Date:	10/06/11
DRO	<10
GRO	NA
B	<25
E	<25
T	<25
X	<75
N	<25

DETAIL A

= ESTIMATED EXTENT OF SOIL IMPACTS ABOVE NR 720 RCLs

LEGEND	
	= UNDERGROUND STORAGE TANK & PIPING: #1 = 10,000-GALLON FUEL OIL #2 = 6,000-GALLON UNLEADED GASOLINE #3 = 10,000-GALLON UNLEADED GASOLINE #4 = 10,000-GALLON UNLEADED GASOLINE
	= FUEL DISPENSER (FORMER)
	SW-1 = UST TSSA SOIL SAMPLE

D-20	
Depth:	2
Date:	10/06/11
DRO	NA
GRO	<10
B	<25
E	<25
T	<25
X	<75
N	<25

D-21	
Depth:	2
Date:	10/06/11
DRO	NA
GRO	(4,200)
B	<2,500
E	{ (13,400) }
T	{ (11,700) }
X	{ (252,000) }
N	{ (118,000) }

P-26	
Depth:	2
Date:	10/06/11
DRO	NA
GRO	<10
B	<25
E	<25
T	<25
X	<75
N	<25

SW-10	
Depth:	11
Date:	10/06/11
DRO	NA
GRO	<10
B	<25
E	<25
T	<25
X	<75
N	<25

B-18	
Depth:	14
Date:	10/06/11
DRO	NA
GRO	(173)
B	(214)
E	2,370
T	680
X	(27,500)
N	(4,100)

SW-9	
Depth:	11
Date:	10/06/11
DRO	NA
GRO	<10
B	<25
E	<25
T	<25
X	<75
N	<25

SW-1	
Depth:	11
Date:	10/06/11
DRO	NA
GRO	<10
B	<25
E	<25
T	<25
X	<75
N	<25

B-19	
Depth:	14
Date:	10/06/11
DRO	NA
GRO	<10
B	<25
E	129
T	224
X	646
N	115

B-11	
Depth:	14
Date:	10/06/11
DRO	NA
GRO	<10
B	(45)
E	128
T	239
X	554
N	89

SW-2	
Depth:	11
Date:	10/06/11
DRO	NA
GRO	<10
B	<25
E	<25
T	<25
X	<75
N	<25

SW-3	
Depth:	11
Date:	10/06/11
DRO	NA
GRO	(370)
B	<25
E	420
T	61
X	890
N	(2,620)

DETAIL B

SW-4	
Depth:	11
Date:	10/06/11
DRO	NA
GRO	(360)
B	(1,030)
E	(3,110)
T	1,130
X	(38,200)
N	(9,800)

SW-5	
Depth:	11
Date:	10/06/11
DRO	NA
GRO	<10
B	(60)
E	167
T	242
X	582
N	177



SOIL QUALITY MAP (2011 UST REMOVALS)

JACOBUS QUICK FUEL (FORMER)
3411 BELL STREET, JANESVILLE, WISCONSIN

FIGURE
2A

NOTES:
1. Dimensions are based on field measurements during TSSA work on October 6, 2011 and should be considered approximate.

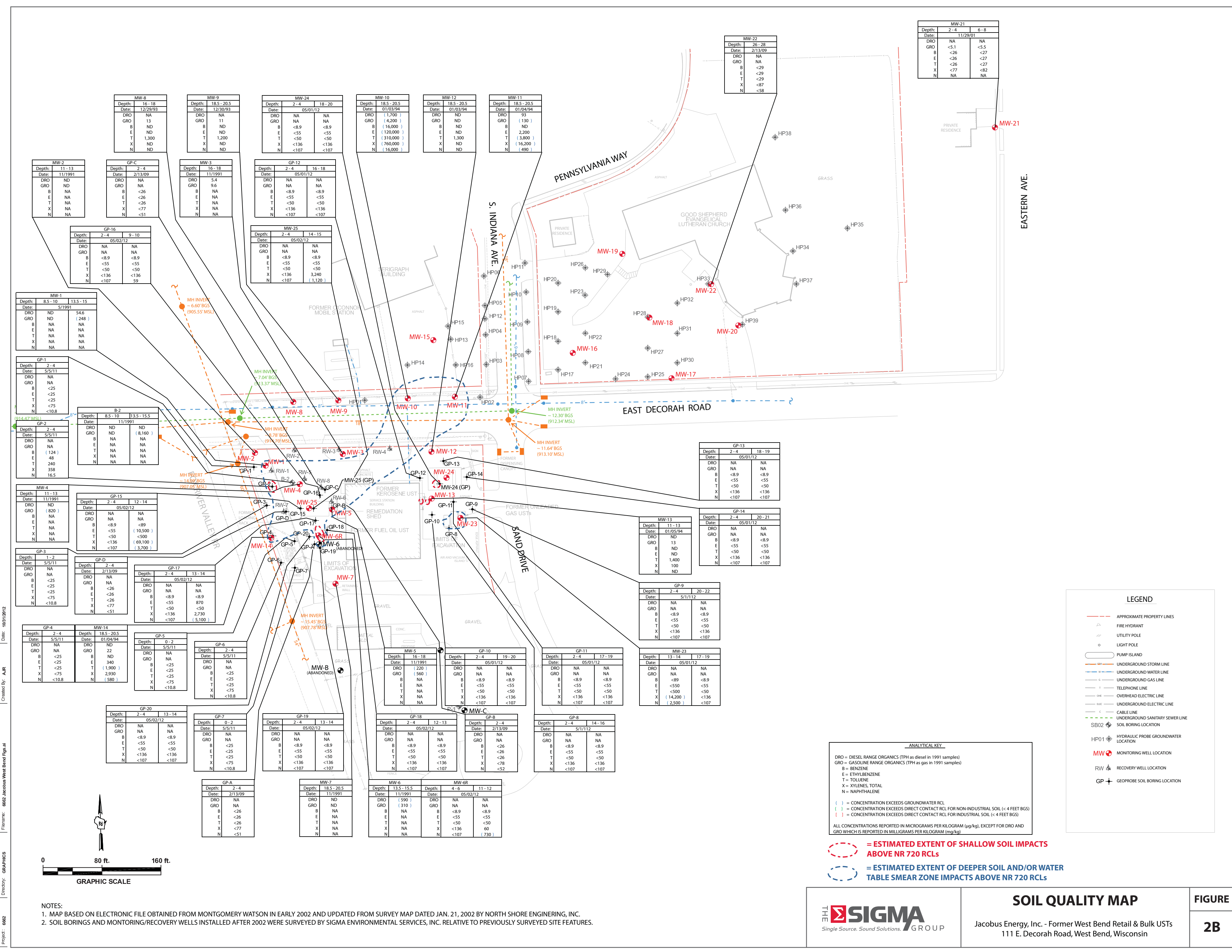

MW-21		
Depth:	2 - 4	6 - 8
Date:	11/29/01	
DRO	NA	NA
GRO	<5.1	<5.5
B	<26	<27
E	<26	<27
T	<26	<27
X	<77	<82
N	NA	NA

MW-22		
Depth:	2 - 4	18 - 19
Date:	2/13/09	
DRO	NA	NA
GRO	(130)	
B	ND	
E	2,200	
T	(3,800)	
X	(16,200)	
N	(490)	

GP-13		
Depth:	2 - 4	18 - 19
Date:	05/01/12	
DRO	NA	NA
GRO	NA	NA
B	<8.9	<8.9
E	<55	<55
T	<50	<50
X	<136	<136
N	<107	<107

GP-14		
Depth:	2 - 4	20 - 21
Date:	05/01/12	
DRO	NA	NA
GRO	NA	NA
B	<8.9	<8.9
E	<55	<55
T	<50	<50
X	<136	<136
N	<107	<107

GP-9		
Depth:	2 - 4	20 - 22
Date:	5/1/12	
DRO	NA	NA
GRO	NA	NA
B	<8.9	<8.9
E	<55	<55
T	<50	<50
X	<136	<136
N	<107	<107

MW-23		
Depth:	13 - 14	17 - 19
Date:	05/01/12	
DRO	NA	NA
GRO	NA	NA
B	<8.9	<8.9
E	<55	<55
T	<50	<50
X	(14,200)	<136
N	(2,500)	<107

LEGEND

- APPROXIMATE PROPERTY LINES
- ⚡ FIRE HYDRANT
- ⚡ UTILITY POLE
- ⦿ LIGHT POLE
- ⊞ PUMP ISLAND
- UNDERGROUND STORM LINE
- UNDERGROUND WATER LINE
- UNDERGROUND GAS LINE
- TELEPHONE LINE
- OVERHEAD ELECTRIC LINE
- UNDERGROUND ELECTRIC LINE
- CABLE LINE
- UNDERGROUND SANITARY SEWER LINE
- ⦿ SB02 SOIL BORING LOCATION
- ⦿ HP01 HYDRAULIC PROBE GROUNDWATER LOCATION
- ⦿ MW MONITORING WELL LOCATION
- ⦿ RW RECOVERY WELL LOCATION
- ⦿ GP GEOPROBE SOIL BORING LOCATION

ANALYTICAL KEY

DRO = DIESEL RANGE ORGANICS (TPH as diesel in 1991 samples)
 GRO = GASOLINE RANGE ORGANICS (TPH as gas in 1991 samples)
 B = BENZENE
 E = ETHYLBENZENE
 T = TOLUENE
 X = XYLENES, TOTAL
 N = NAPHTHALENE

() = CONCENTRATION EXCEEDS GROUNDWATER RCL
 () = CONCENTRATION EXCEEDS DIRECT CONTACT RCL FOR NON-INDUSTRIAL SOIL (< 4 FEET BGS)
 () = CONCENTRATION EXCEEDS DIRECT CONTACT RCL FOR INDUSTRIAL SOIL (< 4 FEET BGS)

ALL CONCENTRATIONS REPORTED IN MICROGRAMS PER KILOGRAM (µg/kg), EXCEPT FOR DRO AND GRO WHICH IS REPORTED IN MILLIGRAMS PER KILOGRAM (mg/kg)

- ESTIMATED EXTENT OF SHALLOW SOIL IMPACTS ABOVE NR 720 RCLS
- ESTIMATED EXTENT OF DEEPER SOIL AND/OR WATER TABLE SMEAR ZONE IMPACTS ABOVE NR 720 RCLS

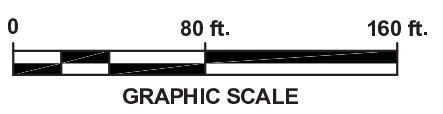

NOTES:
 1. MAP BASED ON ELECTRONIC FILE OBTAINED FROM MONTGOMERY WATSON IN EARLY 2002 AND UPDATED FROM SURVEY MAP DATED JAN. 21, 2002 BY NORTH SHORE ENGINEERING, INC.
 2. SOIL BORINGS AND MONITORING/RECOVERY WELLS INSTALLED AFTER 2002 WERE SURVEYED BY SIGMA ENVIRONMENTAL SERVICES, INC. RELATIVE TO PREVIOUSLY SURVEYED SITE FEATURES.

Single Source. Sound Solutions.

SOIL QUALITY MAP

Jacobus Energy, Inc. - Former West Bend Retail & Bulk USTs
 111 E. Decorah Road, West Bend, Wisconsin

FIGURE
2B

Project: 6662
 Directory: GRAPHICS
 Filename: 6662_Jacobus West Bend Retail & Bulk USTs
 Created By: AAR
 Date: 10/31/2012

This document has been developed for a specific application and may not be used without the written approval of Montgomery Watson.

QUALITY CONTROL

Graphic Standards DLF
Lead Professional ERD

2-4-00
2-4-00

Technical Review MGC
Project Manager

2-8-00

Management Review
Other

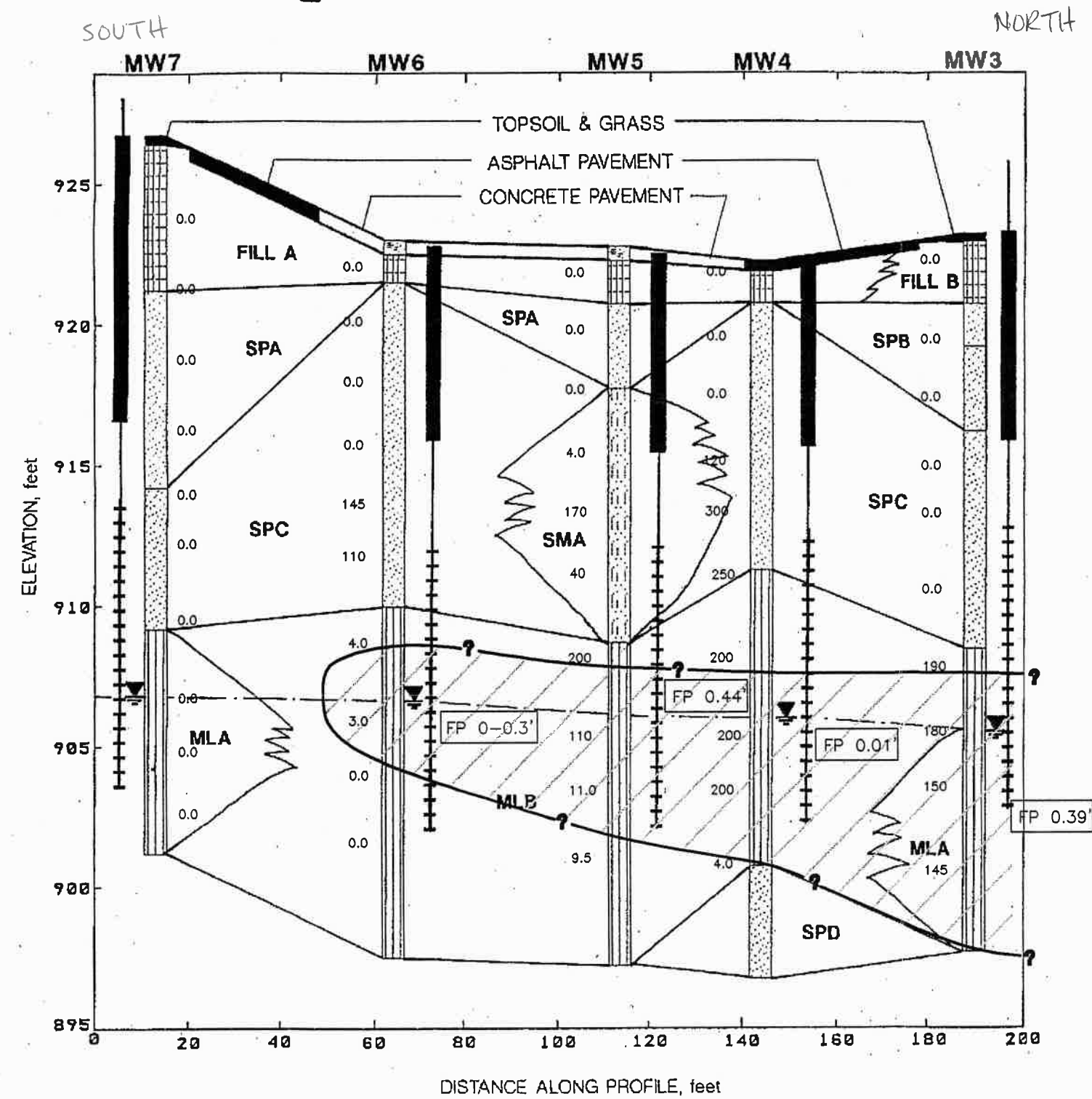

CROSS SECTION SCALE

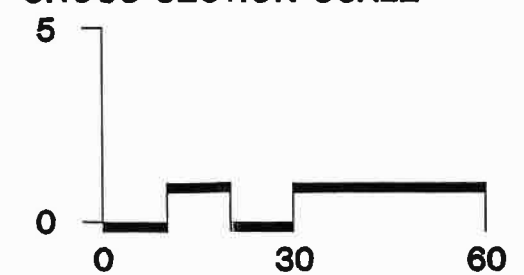

VERTICAL EXAGGERATION: SIX TIMES

LEGEND

- FILL A - BROWN FINE SAND WITH OCCASIONAL CLAY, SILT AND GRAVEL
- FILL B - REDDISH BROWN LEAN CLAY, SOME FINE TO MEDIUM SAND, TRACE GRAVEL
- SPA - BROWN FINE TO MEDIUM SAND, TRACE GRAVEL AND CLAY
- SPB - LIGHT TO DARK BROWN FINE TO MEDIUM SAND, TRACE TO LITTLE GRAVEL, TRACE TO LITTLE SILT, TRACE CLAY
- SPC - TAN FINE SAND, LITTLE SILT, TRACE CLAY
- SPD - GRAYISH BROWN FINE SAND, SOME SILT, TRACE CLAY
- SMA - TAN FINE SILTY SAND, TRACE CLAY
- MLA - TAN SILT, SOME FINE SAND, LITTLE CLAY
- MLB - TAN SANDY SILT, TRACE CLAY
- BENTONITE SEAL
- MONITORING WELL SCREEN
- GROUNDWATER LEVEL ON MARCH 18, 1992
- ESTIMATED WATER TABLE SURFACE
- CROSS-SECTIONAL AREA OF SMEAR ZONE AND GROUNDWATER CONTAMINATION
- HEADSPACE PHOTOIONIZATION DETECTOR (PID) READING ON SOIL SAMPLE, IN INSTRUMENT UNITS (I.U.)

NOTE

1. CROSS-SECTION IS GENERAL IN NATURE AND DOES NOT PURPORT TO BE AN EXACT REPRESENTATION OF SUBSURFACE CONDITIONS.
2. ELEVATIONS ARE RELATIVE TO MEAN SEA LEVEL (MSL) DATUM IN FEET AS SURVEYED BY NATIONAL SURVEY AND ENGINEERING ON JANUARY 7, 1992.
3. ALL HORIZONTAL DISTANCES ARE MEASURED WITH RESPECT TO THE CENTER OF EACH SOIL BORING OR WELL LOCATION. REFER TO FIGURE 2 (SITE PLAN WITH SOIL BORINGS AND GROUNDWATER MONITORING WELL LOCATIONS) FOR LOCATION OF CROSS-SECTION.
4. FP THICKNESS MEASURED ON NOVEMBER 10, 1999.
5. SEE FIGURE 2 FOR GEOLOGIC CROSS-SECTION LOCATION.

CLIENT REVIEW PRINT
 DATE ISSUED: 02-16-2000
 This print has been reviewed and checked in accordance with Montgomery Watson Quality Control Standards.
 SIGNATURE: *[Signature]* 2-16-00

FIGURE 3

Developed By ERD
 Approved By
 Drawn By LCL
 Date
 Reference WARZYN DWG. 2734601-B1
 Revisions
GEOLOGIC CROSS-SECTION A-A
 REQUEST FOR CLOSURE
 THE JACOBUS COMPANY
 111 EAST DECORAH ROAD
 WEST BEND, WISCONSIN
 Drawing Number 1272010
 35160101 **B1**
MONTGOMERY WATSON

This document has been developed for a specific project and is not to be used for any other project without the written approval of Montgomery Watson.

Management Review: 2-5-00
 Technical Review: MGC 2-5-00
 Graphic Standards: DLF 2-4-00
 Lead Professional: ERD 2-4-00
 Quality Control: ERD 2-4-00

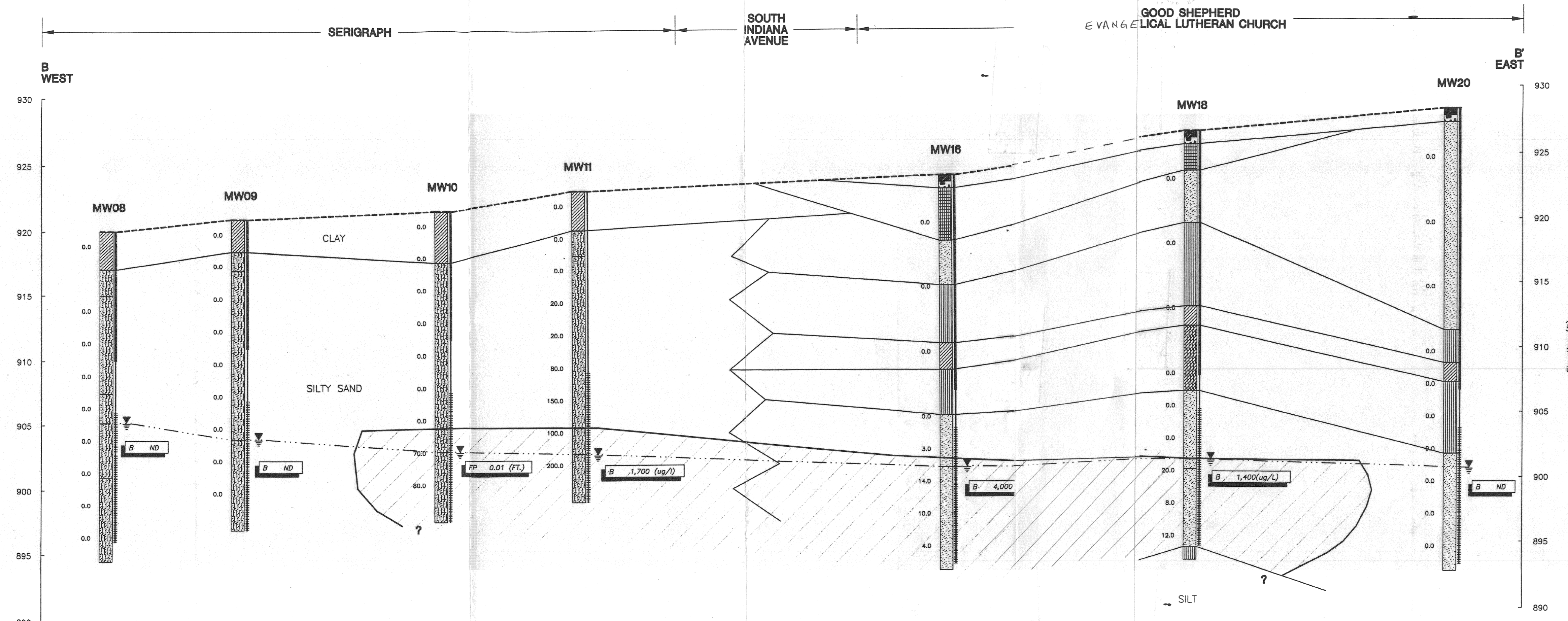

- LEGEND**
- WATER LEVEL ELEVATION
 - WATER TABLE
 - ASPHALT
 - BASE COURSE FILL
 - FILL
 - SAND
 - SILT
 - SILTY SAND
 - INTERBEDDED SILT AND CLAY
 - CLAY
 - B** BENZENE CONCENTRATION IN GROUNDWATER, IN $\mu\text{g/L}$ ON 11-10-99
 - FP** FREE PRODUCT THICKNESS IN FEET, MEASURED ON 11-10-99
 - CROSS-SECTIONAL AREA OF SMEAR ZONE AND GROUNDWATER CONTAMINATION
 - HEADSPACE PHOTOIONIZATION DETECTOR (PID) READING ON SOIL SAMPLE, IN INSTRUMENT UNITS (I.U.)

- NOTES**
- ELEVATIONS ESTABLISHED BASED ON FIELD OBSERVATIONS MADE BY MONTGOMERY WATSON AND REFERENCED TO MEAN SEA LEVEL. SURFACE ELEVATIONS ESTABLISHED BY NATIONAL SURVEY AND ENGINEERING AND LAND INFORMATION SERVICES.
 - FOR THE PURPOSE OF ILLUSTRATING SUBSOIL CONDITIONS ON THE CROSS-SECTIONS, SOME OF THE BORING LOGS HAVE BEEN SIMPLIFIED. FOR DETAILED DESCRIPTIONS OF SUBSURFACE CONDITIONS AT INDIVIDUAL BORINGS, REFER TO SOIL BORING LOGS.
 - THE STRATUM LINES ARE BASED ON INTERPOLATION BETWEEN BORINGS AND MAY NOT REPRESENT ACTUAL SUBSURFACE CONDITIONS. CONTACTS BETWEEN SUBSOIL TYPES MAY BE GRADATIONAL OR INFERRED.
 - HORIZONTAL DISTANCES ARE MEASURED WITH RESPECT TO THE CENTER OF EACH BORING LOCATION.
 - BORINGS MW08-MW11 WERE LOGGED BY WARZYN INC. IN DECEMBER 1993 AND JANUARY 1994.
 - BORINGS MW16-MW20 WERE LOGGED BY MONTGOMERY WATSON IN JANUARY 1996.
 - WATER LEVELS WERE MEASURED BY MONTGOMERY WATSON ON JUNE 18, 1997.
 - BENZENE CONCENTRATIONS WERE FROM GROUND-WATER SAMPLES COLLECTED ON NOVEMBER 10, 1999.
 - FREE PRODUCT THICKNESS MEASURED ON NOVEMBER 10, 1999.
 - SEE FIGURE 2 FOR GEOLOGIC CROSS-SECTION LOCATION.

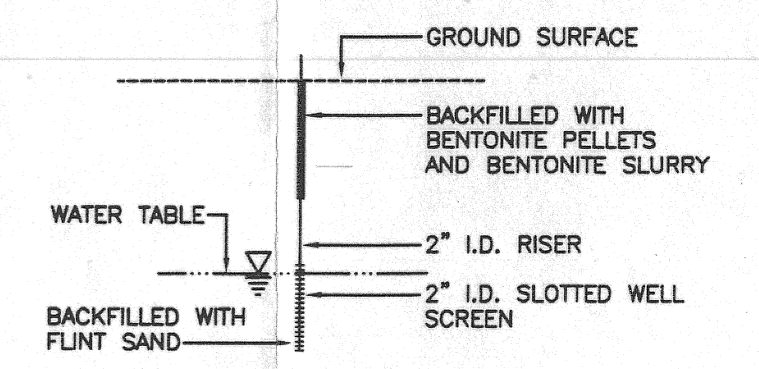

TYPICAL WELL INSTALLATION DETAIL

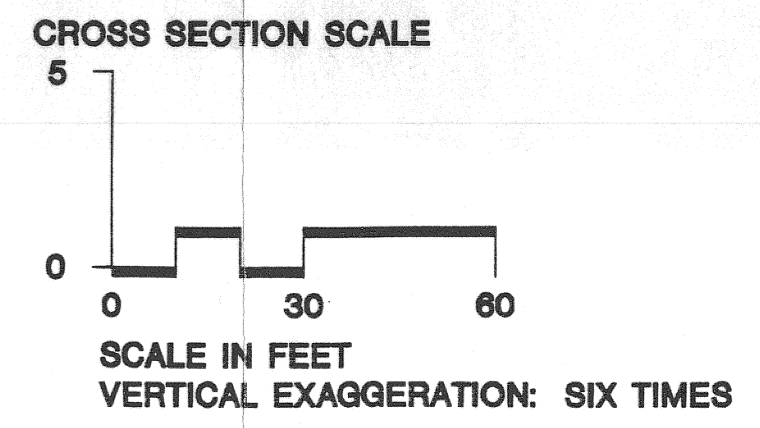

CLIENT REVIEW PRINT
 DATE ISSUED: 02-16-2000
 This print has been reviewed and checked in accordance with Montgomery Watson Quality Control Standards.
 SIGNATURE: [Signature] 2-16-00

Drawn By: LCL
 Date:
 Developed By: ERD
 Approved By:
 Reference: 1272010.18090180-D4
 Revisions:
GEOLOGIC CROSS-SECTION B-5
 REQUEST FOR CLOSURE
 THE JACOBUS COMPANY
 111 EAST DECORAH ROAD
 WEST BEND, WISCONSIN
 Drawing Number: 1272010.35160101
MONTGOMERY WATSON
 FIGURE 4

GOOD SHEPHERD
EVANGELICAL LUTHERAN CHURCH

C SOUTH

C NORTH

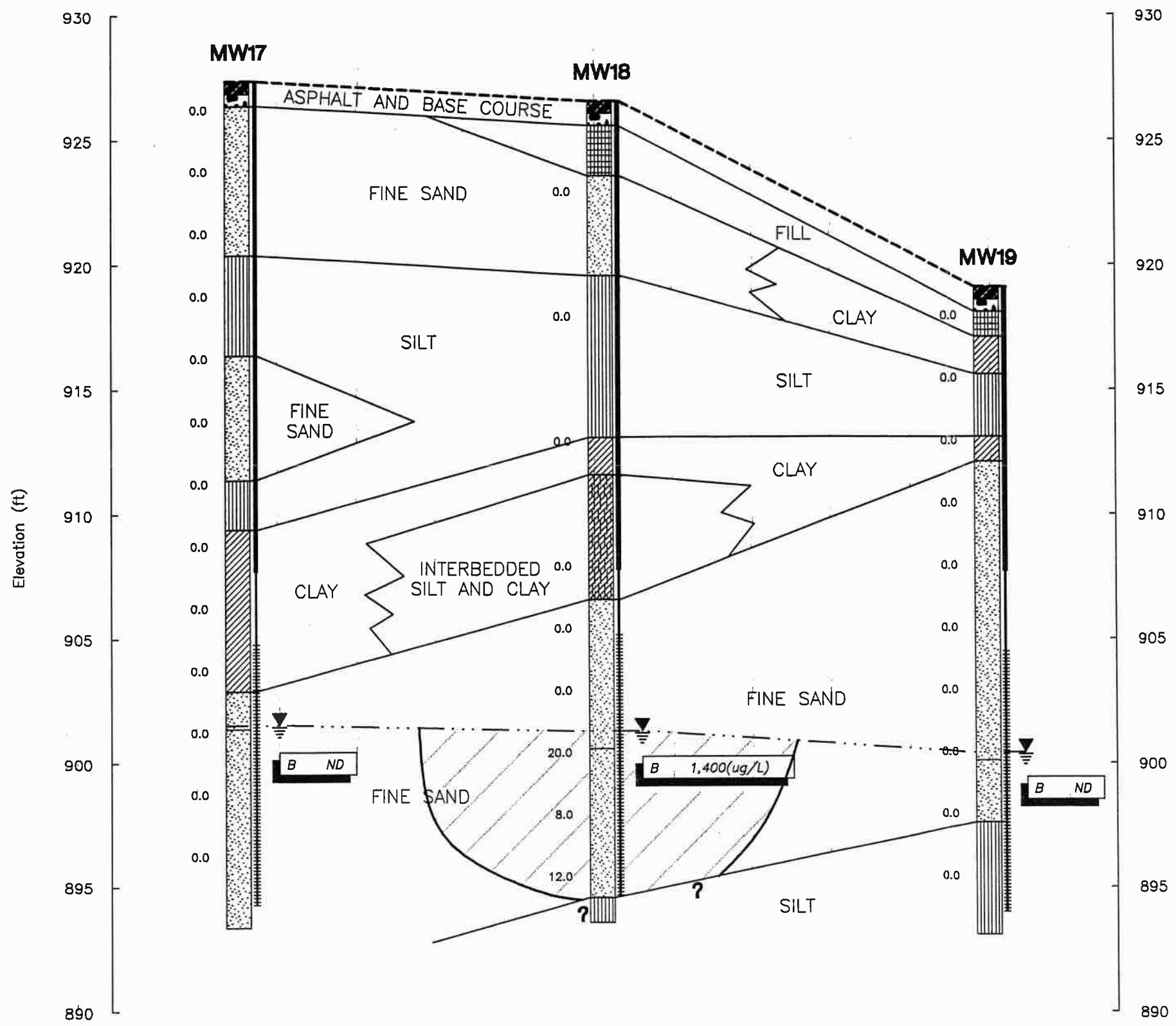

LEGEND

- WATER LEVEL ELEVATION
- WATER TABLE
- ASPHALT
- BASE COURSE FILL
- FILL
- SAND
- SILT
- SILTY SAND
- INTERBEDDED SILT AND CLAY
- CLAY
- B BENZENE CONCENTRATION IN GROUNDWATER, in ug/L
- CROSS-SECTIONAL AREA OF SMEAR ZONE AND GROUNDWATER CONTAMINATION
- 12.0 HEADSPACE PHOTOIONIZATION DETECTOR (PID) READING ON SOIL SAMPLE, IN INSTRUMENT UNITS (I.U.)

NOTES

1. BENZENE CONCENTRATIONS FROM GROUNDWATER SAMPLES COLLECTED ON NOVEMBER 10, 1999.
2. SEE FIGURE 2 FOR GEOLOGIC CROSS-SECTION LOCATION.

CLIENT REVIEW PRINT
 DATE ISSUED: 02-16-2000
 This print has been reviewed and checked in accordance with Montgomery Watson Quality Control Standards.
 SIGNATURE: *[Signature]* 2-16-00

CROSS SECTION SCALE

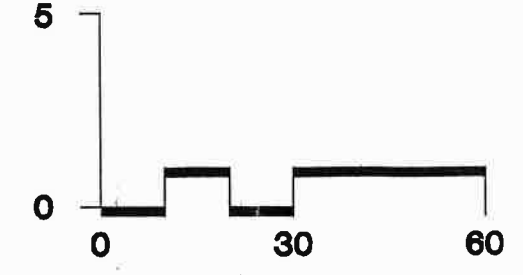

SCALE IN FEET
 VERTICAL EXAGGERATION: SIX TIMES

Developed By ERD
 Approved By
 Reference 1272010
 Revisions

Drawn By LCL
 Date

GEOLOGIC CROSS-SECTION C-C
 REQUEST FOR CLOSURE
 THE JACOBUS COMPANY
 111 EAST DECORAH ROAD
 WEST BEND, WISCONSIN

Drawing Number
 1272010
 35180101 B2

MONTGOMERY WATSON

FIGURE 5

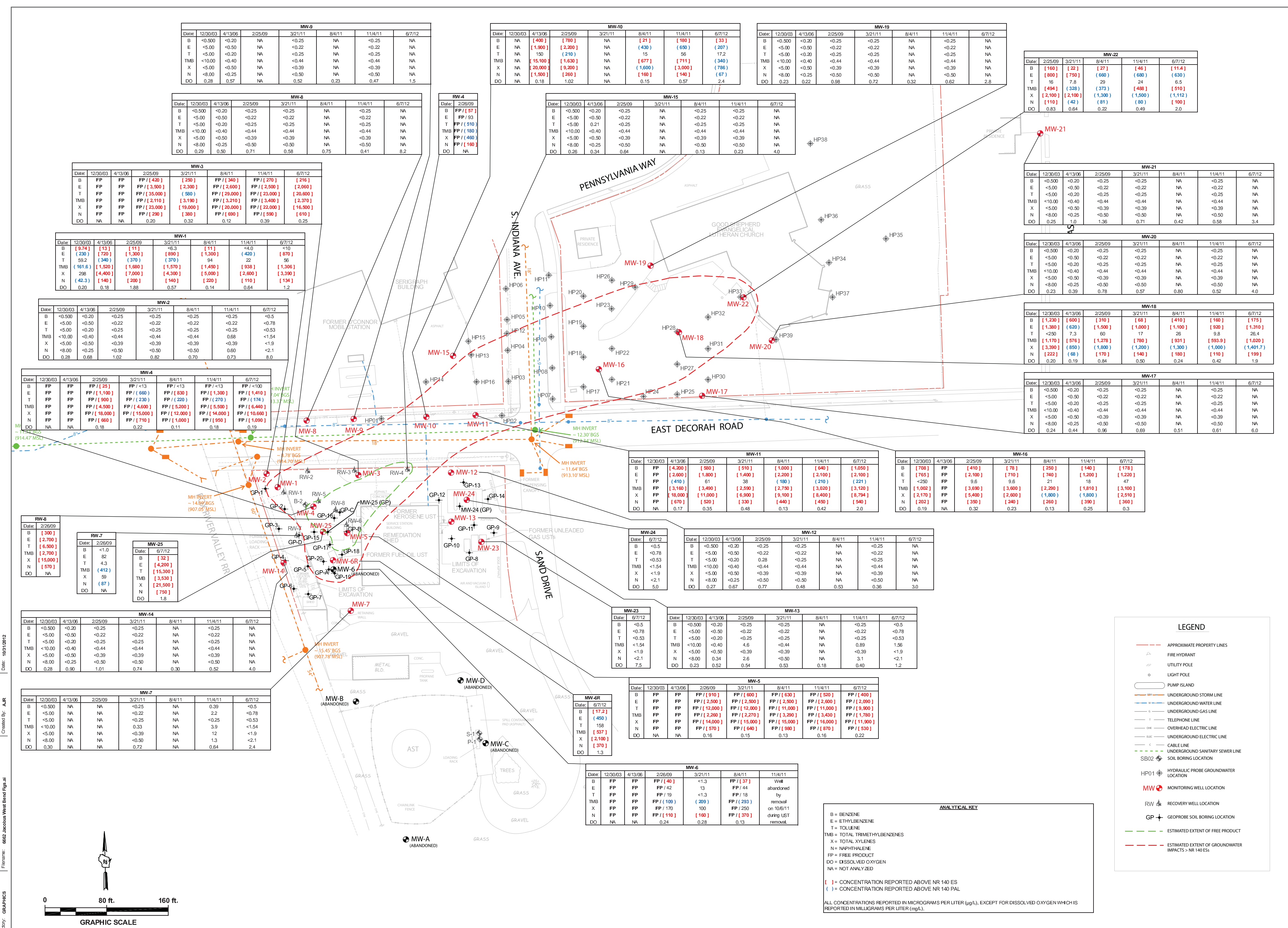

Date: 10/31/2012
 Created By: ABR
 Filename: 6662 Jacobus West Bend Retail Site
 Directory: GRAPHICS
 Project: 6662

NOTES:
 1. MAP BASED ON ELECTRONIC FILE OBTAINED FROM MONTGOMERY WATSON IN EARLY 2002 AND UPDATED FROM SURVEY MAP DATED JAN. 21, 2002 BY NORTH SHORE ENGINEERING, INC.
 2. SOIL BORINGS AND MONITORING/RECOVERY WELLS INSTALLED AFTER 2002 WERE SURVEYED BY SIGMA ENVIRONMENTAL SERVICES, INC. RELATIVE TO PREVIOUSLY SURVEYED SITE FEATURES.



GROUNDWATER QUALITY MAP
 Jacobus Energy, Inc. - Former West Bend Retail & Bulk USTs
 111 E. Decorah Road, West Bend, Wisconsin

FIGURE
2

Project: 6682
 Directory: GRAPHICS
 Filename: 6682_Jacobus West Bend Fig1.dwg
 Created By: AAR
 Date: 10/31/2012

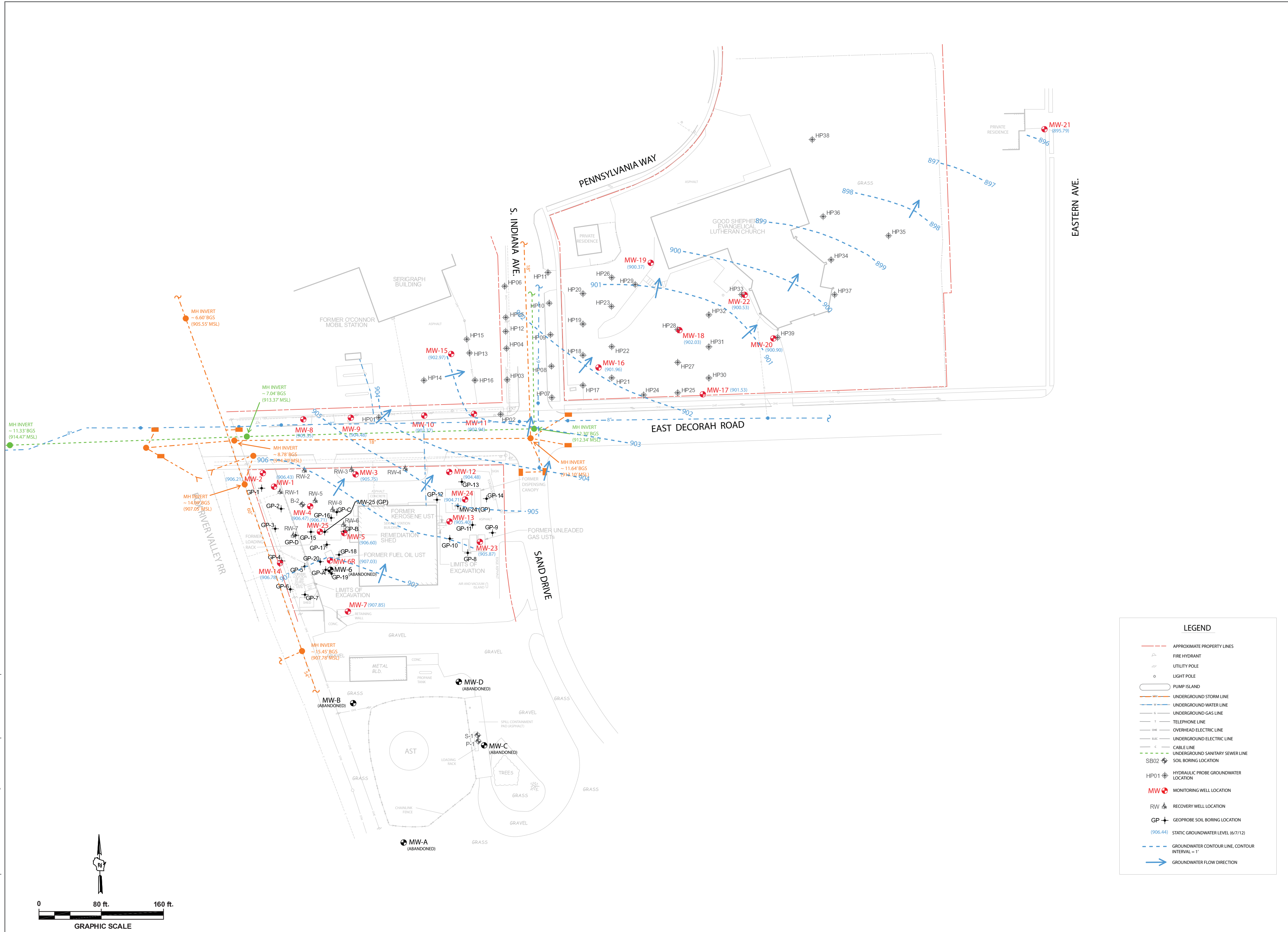

LEGEND	
	APPROXIMATE PROPERTY LINES
	FIRE HYDRANT
	UTILITY POLE
	LIGHT POLE
	PUMP ISLAND
	UNDERGROUND STORM LINE
	UNDERGROUND WATER LINE
	UNDERGROUND GAS LINE
	TELEPHONE LINE
	OVERHEAD ELECTRIC LINE
	UNDERGROUND ELECTRIC LINE
	CABLE LINE
	UNDERGROUND SANITARY SEWER LINE
	SOIL BORING LOCATION
	HP01 HYDRAULIC PROBE GROUNDWATER LOCATION
	MW MONITORING WELL LOCATION
	RW RECOVERY WELL LOCATION
	GP GEOPROBE SOIL BORING LOCATION
	(906.44) STATIC GROUNDWATER LEVEL (6/7/12)
	GROUNDWATER CONTOUR LINE, CONTOUR INTERVAL = 1'
	GROUNDWATER FLOW DIRECTION

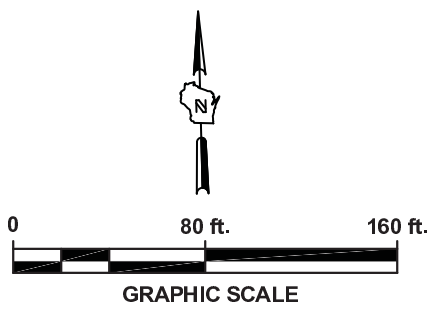

NOTES:
 1. MAP BASED ON ELECTRONIC FILE OBTAINED FROM MONTGOMERY WATSON IN EARLY 2002 AND UPDATED FROM SURVEY MAP DATED JAN. 21, 2002 BY NORTH SHORE ENGINEERING, INC.
 2. SOIL BORINGS AND MONITORING/RECOVERY WELLS INSTALLED AFTER 2002 WERE SURVEYED BY SIGMA ENVIRONMENTAL SERVICES, INC. RELATIVE TO PREVIOUSLY SURVEYED SITE FEATURES.



GROUNDWATER CONTOUR MAP
 (6/7/12)
 Jacobus Energy, Inc. - Former West Bend Retail & Bulk USTs
 111 E. Decorah Road, West Bend, Wisconsin

FIGURE
1

TABLE 3

Soil Boring TPH Concentrations
 The Jacobus Company
 West Bend Bulk Terminal
 111 East Decorah Road
 West Bend, Wisconsin

Soil Boring Sample	Depth (ft)	Head Space PID (ppm)	TPH (mg/kg)		
			G	F2	
MW1 S4	8.5-10	ND(field)	ND	ND	} May 1991
MW1 S5	13.5-15	100 (field)	248	54.6	
MW2 S5	11-13	1.0	ND	ND	} Nov. 1991
MW3 S7	16-18	190	9.6	5.4	
MW4 S5	11-13	300	820	ND	
MW5 S7	16-18	200	560	220	
MW6 S6	13.5-15.5	110	310	590	
MW7 S8	18.5-20.5	ND	ND	ND	} May 1991
B2 S4	8.5-10	ND(field)	ND	ND	
B2 S5	13.5-15.5	70 (field)	8160	ND	

NOTES:

- 1) PID readings are reported in parts per million (ppm) of benzene equivalents.
- 2) G = As Gasoline, F2 = as #2 fuel oil.

KDS/sam/DRL/GJK
 [mil-604-83A]
 2734601/159

TABLE 3

Soil Analytical Results
Groundwater Investigation
West Bend Bluk Terminal and Jiffy Stop Station
111 East Decorah Road
West Bend, Wisconsin

Concentration in milligrams/ per kilogram (mg/kg)

Soil Sample	GRO	DRO	MTBE	Benzene	Toluene	Ethyl Benzene	M-P Xylene	O-Xylene	1,3,5 TMB	1,2,4 TMB	Naphthalene
MW08 (16-18 ft)	13	NA	ND	ND	1.3	ND	ND	ND	0.5	ND	ND
MW09 (18.5-20.5 ft)	11	NA	ND	ND	1.2	ND	ND	ND	0.28	ND	ND
MW10(18.5-20.5 ft)	4,200	1,700	29	16	310	120	560	200	51	280	16
MW11 (18.5-20.5 ft)	130	93	ND	ND	3.8	2.2	11	5.2	1.9	10	0.49
MW12 (18.5-20.5 ft)	ND	ND	ND	ND	1.3	ND	ND	ND	0.44	ND	ND
MW13 (11-13 ft)	13	ND	ND	ND	1.4	ND	0.1	ND	0.22	ND	ND
MW14 (18.5-20.5 ft)	22	ND	ND	ND	1.9	0.34	2.2	0.73	0.59	1.7	0.58
	NR 720 RCL 100	100	NS	0.0055	1.5	2.9	4.1	NS	NS	NS	NS
Notes:	NR 746 Table 1 NS	NS	NS	8.5	38	4.6	42	11	11	83	2.7

- Soil Samples collected by Warzyn Inc. from December 29, 1993 through January 5, 1994.
- Analysis performed by IEA laboratory in Schaumburg, Illinois.
- "ND" indicates analyte not detected above laboratory quantitation limit.
- "NA" indicates sample not analyzed for indicated parameter.
- GRO - Gasoline Range Organics; DRO - Diesel Range Organics; MTBE - Methyl tert-butyl ether; TMB - Trimethylbenzene

**Table 1
Soil Quality Results
Jacobus Energy, Inc. - 111 E. Decorah Road, West Bend, Wisconsin
Sigma Project No. 6662**

Soil Sample Location:	MW-21		MeOH Blank	MW-22	GP-A	GP-B	GP-C	GP-D	Comp-1	Trip Blank	GP-1	GP-2	GP-3	GP-4	GP-5	GP-6	GP-7	Trip Blank	GW RCLs ³	DC RCLs for Non-Industrial Soil ⁴	DC RCLs for Industrial Soil ⁵	
	Sample Depth (feet bgs):	2 - 4	6 - 8	---	26 - 28	2 - 4	2 - 4	2 - 4	2 - 4	---	---	2 - 4	2 - 4	1 - 2	2 - 4	0 - 2	2 - 4	0 - 2				---
Date:	11/29/01	11/29/01	---	2/13/09	2/13/09	2/13/09	2/13/09	2/13/09	2/13/09	2/13/09	5/5/11	5/5/11	5/5/11	5/5/11	5/5/11	5/5/11	5/5/11	5/5/11	5/5/11			
Photoionization Detector	ppm	0	0	---	0	6.8	0	5.1	0	---	---	0	0	0	0	0	0	0	0	NS	NS	NS
Gasoline Range Organics	mg/kg	<5.1	<5.5	<5.0	NA	NA	NA	NA	NA	<5.7	NA	NA	NA	NA	NA	NA	NA	NA	NA	100	NS	NS
Diesel Range Organics	mg/kg	NA	NA	NA	NA	NA	NA	NA	NA	<4.8	NA	NA	NA	NA	NA	NA	NA	NA	NA	100	NS	NS
PVOCs & Detected VOCs																						
Benzene	µg/kg	<26	<27	<25	<29	<26	<26	<26	<26	NA	<25	<25	124	<25	<25	<25	<25	<25	<25	5.5	8,500 / 1,100	NS
Ethylbenzene	µg/kg	<26	<27	<25	<29	<26	<26	<26	<26	NA	<25	<25	48	<25	<25	<25	<25	<25	<25	2,900	4,600 / NS	NS
Methyl-tert-butyl-ether	µg/kg	<26	<27	<25	<29	<26	<26	<26	<26	NA	<25	<25	<25	<25	<25	<25	<25	<25	<25	NS	NS / NS	NS
Naphthalene	µg/kg	NA	NA	NA	<58	<51	<52	<51	<51	NA	<50	See below								NS	2,700 / NS	NS
Toluene	µg/kg	<26	<27	<25	<29	<26	<26	<26	<26	NA	<25	<25	240	<25	<25	<25	<25	<25	<25	1,500	38,000 / NS	NS
1,2,4-Trimethylbenzene	µg/kg	<26	<27	<25	<29	<26	<26	<26	<26	NA	<25	<25	123	<25	<25	<25	<25	<25	<25	NS	83,000 / NS	NS
1,3,5-Trimethylbenzene	µg/kg	<26	<27	<25	<29	<26	<26	<26	<26	NA	<25	<25	59	<25	<25	<25	<25	<25	<25	NS	11,000 / NS	NS
Xylenes (total)	µg/kg	<77	<82	<75	<87	<77	<78	<77	<77	NA	<75	<75	358	<75	<75	<75	<75	<75	<75	4,100	42,000 / NS	NS
PAHs																						
Acenaphthene	µg/kg	NA	NA	NA	NA	NA	NA	NA	NA	NA	NA	<9.7	<9.7	<9.7	<9.7	<9.7	<9.7	<9.7	NA	38,000	900,000	60,000,000
Acenaphthylene	µg/kg	NA	NA	NA	NA	NA	NA	NA	NA	NA	NA	<8.4	<8.4	<8.4	<8.4	<8.4	<8.4	<8.4	NA	700	18,000	360,000
Anthracene	µg/kg	NA	NA	NA	NA	NA	NA	NA	NA	NA	NA	<10.2	<10.2	<10.2	<10.2	<10.2	<10.2	<10.2	NA	3,000,000	5,000,000	300,000,000
Benzo(a)anthracene	µg/kg	NA	NA	NA	NA	NA	NA	NA	NA	NA	NA	<14.6	20 "J"	<14.6	<14.6	<14.6	<14.6	23.2 "J"	NA	17,000	88	3,900
Benzo(a)pyrene	µg/kg	NA	NA	NA	NA	NA	NA	NA	NA	NA	NA	<16.6	<16.6	<16.6	<16.6	<16.6	<16.6	<16.6	NA	48,000	8.8	390
Benzo(b)fluoranthene	µg/kg	NA	NA	NA	NA	NA	NA	NA	NA	NA	NA	<16.7	21.7 "J"	<16.7	<16.7	<16.7	<16.7	21.4 "J"	NA	360,000	88	3,900
Benzo(ghi)perylene	µg/kg	NA	NA	NA	NA	NA	NA	NA	NA	NA	NA	<8.2	23.8 "J"	<8.2	<8.2	<8.2	<8.2	9.6 "J"	NA	6,800,000	1,800	39,000
Benzo(k)fluoranthene	µg/kg	NA	NA	NA	NA	NA	NA	NA	NA	NA	NA	<16.1	<16.1	<16.1	<16.1	<16.1	<16.1	<16.1	NA	870,000	880	39,000
Chrysene	µg/kg	NA	NA	NA	NA	NA	NA	NA	NA	NA	NA	<9.2	10.7 "J"	<9.2	<9.2	<9.2	<9.2	12.2 "J"	NA	37,000	8,800	390,000
Dibenzo(a,h)anthracene	µg/kg	NA	NA	NA	NA	NA	NA	NA	NA	NA	NA	<10.5	<10.5	<10.5	<10.5	<10.5	<10.5	<10.5	NA	38,000	8.8	390
Fluoranthene	µg/kg	NA	NA	NA	NA	NA	NA	NA	NA	NA	NA	<9.8	17.4 "J"	<9.8	<9.8	<9.8	<9.8	29.1 "J"	NA	500,000	600,000	40,000,000
Fluorene	µg/kg	NA	NA	NA	NA	NA	NA	NA	NA	NA	NA	<10.7	<10.7	<10.7	<10.7	<10.7	<10.7	<10.7	NA	100,000	600,000	40,000,000
Indeno(1,2,3-cd)pyrene	µg/kg	NA	NA	NA	NA	NA	NA	NA	NA	NA	NA	<9.5	14.8 "J"	<9.5	<9.5	<9.5	<9.5	<9.5	NA	680,000	88	3,900
1-Methylnaphthalene	µg/kg	NA	NA	NA	NA	NA	NA	NA	NA	NA	NA	<17.9	<17.9	<17.9	<17.9	<17.9	<17.9	<17.9	NA	23,000	1,100,000	70,000,000
2-Methylnaphthalene	µg/kg	NA	NA	NA	NA	NA	NA	NA	NA	NA	NA	<9.6	36	<9.6	<9.6	<9.6	<9.6	<9.6	NA	20,000	600,000	40,000,000
Naphthalene	µg/kg	NA	NA	NA	NA	NA	NA	NA	NA	NA	NA	<10.8	16.5 "J"	<10.8	<10.8	<10.8	<10.8	<10.8	NA	400	20,000	110,000
Phenanthrene	µg/kg	NA	NA	NA	NA	NA	NA	NA	NA	NA	NA	<9.8	10.3 "J"	<9.8	<9.8	<9.8	<9.8	11.5 "J"	NA	1,800	18,000	390,000
Pyrene	µg/kg	NA	NA	NA	NA	NA	NA	NA	NA	NA	NA	<9.5	15.6 "J"	<9.5	<9.5	<9.5	<9.5	22.5 "J"	NA	8,700,000	500,000	30,000,000

- Notes:
1. mg/kg = milligrams per kilogram (equivalent to parts per million, ppm)
 2. µg/kg = micrograms per kilogram (equivalent to parts per billion, ppb)
 3. GW RCLs = Groundwater Residual Contaminant Levels based on the following:
 For petroleum hydrocarbons, GW RCLs based on Wisconsin Administrative Code, Chapter NR 720.09 generic Residual Contaminant Levels for protection of groundwater.
 For PAHs, GW RCLs based on interim guidance RCL for protection of groundwater pathway from PAH compounds, from WDNR publication RR-519-97 "Soil Cleanup Levels for Polycyclic Aromatic Hydrocarbons (PAHs) Interim Guidance" (April 1997)
 4. DC RCLs for Non-Industrial Soil = Direct Contact Residual Contaminant Levels based on the following:
 For petroleum hydrocarbons, DC RCLs based on Wisconsin Administrative Code, Chapter NR 746.06 Table 1 ("Indicators of Residual Petroleum Product in Soil Pores") soil screening levels / Table 2 ("Protection of Human Health from Direct Contact with Contaminated Soil") concentrations.
 For PAHs, DC RCLs based on interim guidance RCL for protection of direct contact with PAH compounds for non-industrial land use, from WDNR publication RR-519-97 "Soil Cleanup Levels for Polycyclic Aromatic Hydrocarbons (PAHs) Interim Guidance" (April 1997)
 5. DC RCLs for Industrial Soil = Direct Contact Residual Contaminant Levels based on the following:
 For PAHs, DC RCLs based on interim guidance RCL for protection of direct contact with PAH compounds for industrial land use, from WDNR publication RR-519-97 "Soil Cleanup Levels for Polycyclic Aromatic Hydrocarbons (PAHs) Interim Guidance" (April 1997)
 6. NA = not analyzed
 7. NS = no standard established
 8. Laboratory flags: "J" = analyte detected between Limit of Detection and Limit of Quantitation (estimated concentration)
 9. Exceedances: **bold** = Concentration exceeds GW RCL
underline = Concentration exceeds DC RCL for Non-Industrial Soil
[brackets] = Concentration exceeds DC RCL for Industrial Soil

Table 5
TSSA Soil Quality Results
Former Jacobus Quick Fuel & Bulk Plant - 111 E. Decorah Road, West Bend, Wisconsin
Sigma Project No. 12805

UST Information:		Retail UST Systems: One 6,000-Gallon Unleaded Gasoline UST and Two 10,000-Gallon Unleaded Gasoline USTs																										GW RCLs ⁴	DC RCLs ⁵	
Sample Location:		UST Basin Sidewall Samples										UST Basin Base Samples										Dispenser Samples				Piping Samples				
Soil Sample Identification:		SW-1	SW-2	SW-3	SW-4	SW-5	SW-6	SW-7	SW-8	SW-9	SW-10	B-11	B-12	B-13	B-14	B-15	B-16	B-17	B-18	B-19	D-20	D-21	D-22	D-23	P-24	P-25	P-26			
Sample Depth (feet bgs):		11	11	11	11	11	11	11	11	11	11	14	14	14	14	14	14	14	14	14	14	14	14	2	2	2	2			2
Date:		10/6/11																												
Organic Vapor Monitor (ppm):		57	0	328	428	331	376	201	0	15	0	315	321	371	411	423	284	253	127	334	45	423	152	148	0	11	18			
Diesel Range Organics	mg/kg	NA	NA	NA	NA	NA	NA	NA	NA	NA	NA	NA	NA	NA	NA	NA	NA	NA	NA	NA	NA	NA	NA	NA	NA	NA	NA	NA	100	NS
Gasoline Range Organics	mg/kg	<10	<10	370 "J,O"	360	<10	670	<10	<10	<10	<10	<10	<10	450	30 "O"	47 "O"	34 "O"	18 "O"	173	<10	<10	4,200	<10	<10	<10	<10	<10	100	NS	
PVOCs + Naphthalene																														
Benzene	µg/kg	<25	<25	<25	1,030	60	7,100	<25	<25	<25	<25	45	110	700	<25	<25	<25	<25	214	<25	<25	<2,500	<25	<25	<25	<25	<25	<25	5.5	8,500 / 1,100
Ethylbenzene	µg/kg	<25	<25	420	3,110	167	[19,800]	37	<25	<25	<25	128	281	[7,300]	48	244	126	164	2,370	129	<25	[13,400]	<25	<25	<25	<25	<25	2,900	4,600 / NS	
Methyl-tert-butyl-ether	µg/kg	<25	<25	<25	<250	<25	<250	<25	<25	<25	<25	<25	<25	<250	<25	<25	<25	<25	<25	<25	<25	<2,500	<25	<25	<25	<25	<25	NS	NS	
Naphthalene	µg/kg	<25	<25	2,620	[9,800]	177	[10,600]	<25	<25	<25	<25	89	162	[10,100]	1,020	2,080	1,600	1,270	[4,100]	115	<25	[118,000]	<25	<25	<25	<25	<25	NS	2,700 / NS	
Toluene	µg/kg	<25	<25	61	1,130	242	[46,000]	111	<25	<25	<25	239	500	2,820	57	175	80	142	680	224	<25	11,700	<25	<25	<25	<25	<25	1,500	38,000 / NS	
1,2,4-Trimethylbenzene	µg/kg	<25	<25	4,500	52,000	560	55,000	66	<25	<25	<25	370	810	56,000	1,630	3,130	1,980	1,410	19,700	510	<25	[620,000]	99	64	<25	<25	<25	NS	83,000 / NS	
1,3,5-Trimethylbenzene	µg/kg	<25	<25	4,800	[20,500]	410	[19,200]	45	<25	<25	<25	158	330	[21,700]	590	1,160	730	530	7,400	203	<25	[284,000]	47	30.1	<25	<25	<25	NS	11,000 / NS	
Xylenes (total)	µg/kg	<75	<75	890	38,200	582	[95,800]	144	<75	<75	<75	554	1,380	[76,400]	468	1,030	700	750	27,500	646	<75	[252,000]	<75	27.5	<75	<75	<75	4,100	42,000 / NS	

UST Information:		Bulk UST System: One 10,000-Gallon Fuel Oil UST										GW RCLs ⁴	DC RCLs ⁵
Sample Location:		UST Basin Sidewall Samples					UST Basin Base Samples			Piping Sample	Trip Blank		
Soil Sample Identification:		SWFO-1	SWFO-2	SWFO-3	SWFO-4	SWFO-5	SWFO-6	BFO-7	BFO-8	PFO-9			
Sample Depth (feet bgs):		10	10	10	10	10	10	13	13	2	---		
Date:		10/6/11											
Organic Vapor Monitor (ppm):		11	14	2	0	0	103	422	428	0	---		
Diesel Range Organics	mg/kg	32.9	33.3	<10	<10	<10	663	11,200	8,110	16.6	NA	100	NS
Gasoline Range Organics	mg/kg	NA	NA	NA	NA	NA	NA	NA	NA	NA	NA	100	NS
PVOCs + Naphthalene													
Benzene	µg/kg	<25	<25	<25	<25	<25	<25	<25	<25	<25	<25	5.5	8,500 / 1,100
Ethylbenzene	µg/kg	<25	<25	<25	<25	<25	47	1,050	760	<25	<25	2,900	4,600 / NS
Methyl-tert-butyl-ether	µg/kg	<25	<25	<25	<25	<25	<25	<25	<25	<25	<25	NS	NS
Naphthalene	µg/kg	<25	<25	<25	<25	<25	1,120	[14,500]	[9,300]	<25	<25	NS	2,700 / NS
Toluene	µg/kg	<25	<25	<25	<25	<25	44	314	<25	<25	<25	1,500	38,000 / NS
1,2,4-Trimethylbenzene	µg/kg	<25	<25	<25	<25	<25	287	9,200	6,300	<25	<25	NS	83,000 / NS
1,3,5-Trimethylbenzene	µg/kg	<25	<25	<25	<25	<25	152	5,200	3,200	<25	<25	NS	11,000 / NS
Xylenes (total)	µg/kg	<75	<75	<75	<75	<75	181 "J"	3,340	3,230	<75	<75	4,100	42,000 / NS

- Notes:
- mg/kg = milligrams per kilogram (equivalent to parts per million, ppm)
 - µg/kg = micrograms per kilogram (equivalent to parts per billion, ppb)
 - NA = not analyzed
 - GW RCLs = Groundwater Residual Contaminant Levels from Wisconsin Administrative Code, Chapter NR 720.09.
 - DC RCLs = Direct Contact Residual Contaminant Levels from Wisconsin Administrative Code, Chapter NR 746.06 Table 1 ("Indicators of Residual Petroleum Product in Soil Pores") soil screening levels / Table 2 ("Protection of Human Health from Direct Contact with Contaminated Soil") concentrations.
 - NS = no standard established
 - Laboratory flags: "J" = Analyte detected between Limit of Detection and Limit of Quantitation
"O" = Contamination indicated outside GRO window
 - Exceedances: box = Concentration exceeds GW RCL
[brackets] = Concentration exceeds DC RCL

Table 2
Soil Quality Results - Site Investigation
Former Jacobus Quick Fuel - 111 E. Decorah Road, West Bend, Wisconsin
Sigma Project No. 12805-003

Soil Sample Location:	Date:	GP-8		GP-9		GP-10		GP-11		GP-12		GP-13		GP-14		MW-23		MW-24		GW RCLs ⁴	DC RCLs for Non-Industrial Soil ⁵	DC RCLs for Industrial Soil ⁶
		2 - 4	14 - 16	2 - 4	20 - 22	2 - 4	19 - 20	2 - 4	17 - 19	2 - 4	16 - 18	2 - 4	18 - 19	2 - 4	20 - 21	13 - 14	17 - 19	2 - 4	18 - 20			
Organic Vapor Monitor	ppm	0	0	0	0	0	115	0	0	0	0	0	0	0	0	104	1	0	0	NS	NS	NS
Diesel Range Organics	mg/kg	NA	NA	NA	NA	NA	NA	NA	NA	NA	NA	NA	NA	NA	NA	NA	NA	NA	NA	100	NS	NS
Gasoline Range Organics	mg/kg	NA	NA	NA	NA	NA	NA	NA	NA	NA	NA	NA	NA	NA	NA	NA	NA	NA	NA	100	NS	NS
PVOCs & Detected VOCs																						
Benzene	µg/kg	<8.9	<8.9	<8.9	<8.9	<8.9	<8.9	<8.9	<8.9	<8.9	<8.9	<8.9	<8.9	<8.9	<8.9	<89	<8.9	<8.9	<8.9	5.5	8,500 / 1,100	NS
sec-Butylbenzene	µg/kg	<51	<51	<51	<51	<51	<51	<51	<51	<51	<51	<51	<51	<51	<51	<510	<51	<51	<51	NS	NS	NS
n-Butylbenzene	µg/kg	<48	<48	<48	<48	<48	50 "J"	<48	<48	<48	<48	<48	<48	<48	<48	1,300 "J"	<48	<48	<48	NS	NS	NS
Ethylbenzene	µg/kg	<55	<55	<55	<55	<55	<55	<55	<55	<55	<55	<55	<55	<55	<55	<550	<55	<55	<55	2,900	4,600 / NS	NS
Isopropylbenzene	µg/kg	<53	<53	<53	<53	<53	<53	<53	<53	<53	<53	<53	<53	<53	<53	<530	<53	<53	<53	NS	NS	NS
p-Isopropyltoluene	µg/kg	<45	<45	<45	<45	<45	50 "J"	<45	<45	<45	<45	<45	<45	<45	<45	<450	<45	<45	<45	NS	NS	NS
Methyl-tert-butyl-ether	µg/kg	<12	<12	<12	<12	<12	<12	<12	<12	<12	<12	<12	<12	<12	<12	<120	<12	<12	<12	NS	NS	NS
Naphthalene	µg/kg	<107	<107	<107	<107	<107	<107	<107	<107	<107	<107	<107	<107	<107	<107	(2,500 "J")	<107	<107	<107	See below	2,700 / NS	NS
n-Propylbenzene	µg/kg	<53	<53	<53	<53	<53	<53	<53	<53	<53	<53	<53	<53	<53	<53	1,100 "J"	<53	<53	<53	NS	NS	NS
Toluene	µg/kg	<50	<50	<50	<50	<50	<50	<50	<50	<50	<50	<50	<50	<50	<50	<500	<50	<50	<50	1,500	38,000 / NS	NS
1,2,4-Trimethylbenzene	µg/kg	<80	<80	<80	<80	<80	<80	<80	<80	<80	<80	<80	<80	<80	<80	18,000	<80	<80	<80	NS	83,000 / NS	NS
1,3,5-Trimethylbenzene	µg/kg	<48	<48	<48	<48	<48	<48	<48	<48	<48	<48	<48	<48	<48	<48	6,400	<48	<48	<48	NS	11,000 / NS	NS
Xylenes (total)	µg/kg	<136	<136	<136	<136	<136	<136	<136	<136	<136	<136	<136	<136	<136	<136	(14,200)	<136	<136	<136	4,100	42,000 / NS	NS
PAHs																						
Acenaphthene	µg/kg	NA	NA	NA	NA	NA	NA	NA	NA	NA	NA	NA	NA	NA	NA	NA	NA	NA	NA	38,000	900,000	60,000,000
Acenaphthylene	µg/kg	NA	NA	NA	NA	NA	NA	NA	NA	NA	NA	NA	NA	NA	NA	NA	NA	NA	NA	700	18,000	360,000
Anthracene	µg/kg	NA	NA	NA	NA	NA	NA	NA	NA	NA	NA	NA	NA	NA	NA	NA	NA	NA	NA	3,000,000	5,000,000	300,000,000
Benzo(a)anthracene	µg/kg	NA	NA	NA	NA	NA	NA	NA	NA	NA	NA	NA	NA	NA	NA	NA	NA	NA	NA	17,000	88	3,900
Benzo(a)pyrene	µg/kg	NA	NA	NA	NA	NA	NA	NA	NA	NA	NA	NA	NA	NA	NA	NA	NA	NA	NA	48,000	8.8	390
Benzo(b)fluoranthene	µg/kg	NA	NA	NA	NA	NA	NA	NA	NA	NA	NA	NA	NA	NA	NA	NA	NA	NA	NA	360,000	88	3,900
Benzo(ghi)perylene	µg/kg	NA	NA	NA	NA	NA	NA	NA	NA	NA	NA	NA	NA	NA	NA	NA	NA	NA	NA	6,800,000	1,800	39,000
Benzo(k)fluoranthene	µg/kg	NA	NA	NA	NA	NA	NA	NA	NA	NA	NA	NA	NA	NA	NA	NA	NA	NA	NA	870,000	880	39,000
Chrysene	µg/kg	NA	NA	NA	NA	NA	NA	NA	NA	NA	NA	NA	NA	NA	NA	NA	NA	NA	NA	37,000	8,800	390,000
Dibenzo(a,h)anthracene	µg/kg	NA	NA	NA	NA	NA	NA	NA	NA	NA	NA	NA	NA	NA	NA	NA	NA	NA	NA	38,000	8.8	390
Fluoranthene	µg/kg	NA	NA	NA	NA	NA	NA	NA	NA	NA	NA	NA	NA	NA	NA	NA	NA	NA	NA	500,000	600,000	40,000,000
Fluorene	µg/kg	NA	NA	NA	NA	NA	NA	NA	NA	NA	NA	NA	NA	NA	NA	NA	NA	NA	NA	100,000	600,000	40,000,000
Indeno(1,2,3-cd)pyrene	µg/kg	NA	NA	NA	NA	NA	NA	NA	NA	NA	NA	NA	NA	NA	NA	NA	NA	NA	NA	680,000	88	3,900
1-Methylnaphthalene	µg/kg	NA	NA	NA	NA	NA	NA	NA	NA	NA	NA	NA	NA	NA	NA	NA	NA	NA	NA	23,000	1,100,000	70,000,000
2-Methylnaphthalene	µg/kg	NA	NA	NA	NA	NA	NA	NA	NA	NA	NA	NA	NA	NA	NA	NA	NA	NA	NA	20,000	600,000	40,000,000
Naphthalene	µg/kg	NA	NA	NA	NA	NA	NA	NA	NA	NA	NA	NA	NA	NA	NA	NA	NA	NA	NA	400	20,000	110,000
Phenanthrene	µg/kg	NA	NA	NA	NA	NA	NA	NA	NA	NA	NA	NA	NA	NA	NA	NA	NA	NA	NA	1,800	18,000	390,000
Pyrene	µg/kg	NA	NA	NA	NA	NA	NA	NA	NA	NA	NA	NA	NA	NA	NA	NA	NA	NA	NA	8,700,000	500,000	30,000,000

- Notes:
- µg/kg = micrograms per kilogram (equivalent to parts per billion, ppb)
 - mg/kg = milligrams per kilogram (equivalent to parts per million, ppm)
 - NA = not analyzed
 - GW RCLs = Groundwater Residual Contaminant Levels based on the following:
 For petroleum hydrocarbons, GW RCLs based on Wisconsin Administrative Code, Chapter NR 720.09 generic Residual Contaminant Levels for protection of groundwater.
 For PAHs, GW RCLs based on interim guidance RCL for protection of groundwater pathway from PAH compounds, from WDNR publication RR-519-97 "Soil Cleanup Levels for Polycyclic Aromatic Hydrocarbons (PAHs) Interim Guidance" (April 1997)
 - DC RCLs for Non-Industrial Soil = Direct Contact Residual Contaminant Levels based on the following:
 For petroleum hydrocarbons, DC RCLs based on Wisconsin Administrative Code, Chapter NR 746.06 Table 1 ("Indicators of Residual Petroleum Product in Soil Pores") soil screening levels / Table 2 ("Protection of Human Health from Direct Contact with Contaminated Soil") concentrations.
 For PAHs, DC RCLs based on interim guidance RCL for protection of direct contact with PAH compounds for non-industrial land use, from WDNR publication RR-519-97 "Soil Cleanup Levels for Polycyclic Aromatic Hydrocarbons (PAHs) Interim Guidance" (April 1997)
 - DC RCLs for Industrial Soil = Direct Contact Residual Contaminant Levels based on the following:
 For PAHs, DC RCLs based on interim guidance RCL for protection of direct contact with PAH compounds for industrial land use, from WDNR publication RR-519-97 "Soil Cleanup Levels for Polycyclic Aromatic Hydrocarbons (PAHs) Interim Guidance" (April 1997)
 - NS = no standard established
 - Laboratory flags: "J" = Analyte detected between Limit of Detection and Limit of Quantitation
 - Exceedances: () = Concentration exceeds GW RCL
 { } = Concentration exceeds DC RCL for Non-Industrial Soil
 [] = Concentration exceeds DC RCL for Industrial Soil

Table 3
Soil Quality Results - Site Investigation
Former Jacobus Bulk Plant - 111 E. Decorah Road, West Bend, Wisconsin
Sigma Project No. 12805-004

Soil Sample Location:		GP-15		GP-16		GP-17		GP-18		GP-19		GP-20		MW-6R		MW-25		GW RCLs ⁴	DC RCLs for Non-Industrial Soil ⁵	DC RCLs for Industrial Soil ⁶
Sample Depth (feet bgs):		2 - 4	12 - 14	2 - 4	9 - 10	2 - 4	13 - 14	2 - 4	12 - 13	2 - 4	13 - 14	2 - 4	13 - 14	4 - 6	11 - 12	2 - 4	14 - 15			
Date:		05/02/12		05/02/12		05/02/12		05/02/12		05/02/12		05/02/12		05/02/12		05/02/12				
Organic Vapor Monitor	ppm	4	289	1	62	3	149	0	34	0	3	3	7	3	79	1	98	NS	NS	NS
Diesel Range Organics	mg/kg	NA	NA	NA	NA	NA	NA	NA	NA	NA	NA	NA	NA	NA	NA	NA	NA	100	NS	NS
Gasoline Range Organics	mg/kg	NA	NA	NA	NA	NA	NA	NA	NA	NA	NA	NA	NA	NA	NA	NA	NA	100	NS	NS
PVOCs & Detected VOCs																				
Benzene	µg/kg	<8.9	<89	<8.9	<8.9	<8.9	<8.9	<8.9	<8.9	<8.9	<8.9	<8.9	<8.9	<8.9	<8.9	<8.9	<8.9	5.5	8,500 / 1,100	NS
sec-Butylbenzene	µg/kg	<51	670 "J"	<51	<51	<51	1,160	<51	<51	<51	<51	<51	<51	<51	77 "J"	<51	<51	NS	NS	NS
n-Butylbenzene	µg/kg	<48	2,660	<48	93 "J"	<48	1,420	<48	<48	<48	<48	<48	<48	<48	240	<48	760	NS	NS	NS
Ethylbenzene	µg/kg	<55	{ 10,500 }	<55	<55	<55	870	<55	<55	<55	<55	<55	<55	<55	<55	<55	<55	2,900	4,600 / NS	NS
Isopropylbenzene	µg/kg	<53	<530	<53	<53	<53	450	<53	<53	<53	<53	<53	<53	<53	<53	<53	<53	NS	NS	NS
p-Isopropyltoluene	µg/kg	<45	1,730	<45	<45	<45	690	<45	<45	<45	<45	<45	<45	<45	107 "J"	<45	82 "J"	NS	NS	NS
Methyl-tert-butyl-ether	µg/kg	<12	<120	<12	<12	<12	<12	<12	<12	<12	<12	<12	<12	<12	<12	<12	<12	NS	NS	NS
Naphthalene	µg/kg	<107	{ 3,700 }	<107	<107	<107	{ 5,100 }	<107	<107	<107	<107	<107	<107	<107	(730)	<107	(1,120)	See below	2,700 / NS	NS
n-Propylbenzene	µg/kg	<53	5,500	<53	<53	<53	810	<53	<53	<53	<53	<53	<53	<53	<53	<53	<53	NS	NS	NS
Toluene	µg/kg	<50	<500	<50	<50	<50	<50	<50	<50	<50	<50	<50	<50	<50	<50	<50	<50	1,500	38,000 / NS	NS
1,2,4-Trimethylbenzene	µg/kg	<80	39,000	<80	<80	<80	4,000	<80	<80	<80	<80	<80	<80	<80	294	<80	4,800	NS	83,000 / NS	NS
1,3,5-Trimethylbenzene	µg/kg	<48	{ 11,900 }	<48	<48	<48	1,230	<48	<48	<48	<48	<48	<48	<48	261	<48	2,880	NS	11,000 / NS	NS
Xylenes (total)	µg/kg	<136	{ 69,100 }	<136	<136	<136	2,730	<136	<136	<136	<136	<136	<136	<136	60 "J"	<136	3,240	4,100	42,000 / NS	NS
PAHs																				
Acenaphthene	µg/kg	<16.4	72	<16.4	146	<16.4	690	<16.4	<16.4	<16.4	23.7 "J"	<16.4	<16.4	<16.4	22.9 "J"	<16.4	360	38,000	900,000	60,000,000
Acenaphthylene	µg/kg	<21	23.8 "J"	<21	41 "J"	<21	215 "J"	<21	<21	<21	<21	<21	<21	<21	<21	<21	145	700	18,000	360,000
Anthracene	µg/kg	<18.9	19.2 "J"	<18.9	165	<18.9	99 "J"	<18.9	<18.9	<18.9	<18.9	<18.9	<18.9	<18.9	30.7 "J"	<18.9	102	3,000,000	5,000,000	300,000,000
Benzo(a)anthracene	µg/kg	<21.4	<21.4	<21.4	22.9 "J"	<21.4	<107	<21.4	<21.4	<21.4	<21.4	<21.4	<21.4	<21.4	<21.4	<21.4	<21.4	17,000	88	3,900
Benzo(a)pyrene	µg/kg	<19.3	<19.3	<19.3	<19.3	<19.3	<96.5	<19.3	<19.3	<19.3	<19.3	<19.3	<19.3	<19.3	<19.3	<19.3	<19.3	48,000	8.8	390
Benzo(b)fluoranthene	µg/kg	<26.7	<26.7	<26.7	<26.7	<26.7	<133.5	<26.7	<26.7	<26.7	<26.7	<26.7	<26.7	<26.7	<26.7	<26.7	<26.7	360,000	88	3,900
Benzo(ghi)perylene	µg/kg	<20.9	<20.9	<20.9	<20.9	<20.9	<104.5	<20.9	<20.9	<20.9	<20.9	<20.9	<20.9	<20.9	<20.9	<20.9	<20.9	6,800,000	1,800	39,000
Benzo(k)fluoranthene	µg/kg	<18	<18	<18	<18	<18	<90	<18	<18	<18	<18	<18	<18	<18	<18	<18	<18	870,000	880	39,000
Chrysene	µg/kg	<20.3	<20.3	<20.3	54 "J"	<20.3	<101.5	<20.3	<20.3	<20.3	<20.3	<20.3	<20.3	<20.3	<20.3	<20.3	21.5 "J"	37,000	8,800	390,000
Dibenzo(a,h)anthracene	µg/kg	<24.4	<24.4	<24.4	<24.4	<24.4	<122	<24.4	<24.4	<24.4	<24.4	<24.4	<24.4	<24.4	<24.4	<24.4	<24.4	38,000	8.8	390
Fluoranthene	µg/kg	<21.2	33 "J"	<21.2	38 "J"	<21.2	<106	<21.2	<21.2	<21.2	<21.2	<21.2	<21.2	<21.2	22.6 "J"	<21.2	65 "J"	500,000	600,000	40,000,000
Fluorene	µg/kg	<20.3	158	<20.3	92	<20.3	1,530	<20.3	<20.3	<20.3	<20.3	<20.3	<20.3	<20.3	52 "J"	<20.3	880	100,000	600,000	40,000,000
Indeno(1,2,3-cd)pyrene	µg/kg	<23.7	<23.7	<23.7	<23.7	<23.7	<118.5	<23.7	<23.7	<23.7	<23.7	<23.7	<23.7	<23.7	<23.7	<23.7	<23.7	680,000	88	3,900
1-Methylnaphthalene	µg/kg	<21	1,600	<21	69	<21	9,400	<21	<21	<21	21.9 "J"	<21	<21	<21	24.7 "J"	<21	5,900	23,000	1,100,000	70,000,000
2-Methylnaphthalene	µg/kg	<22.4	3,300	<22.4	67 "J"	<22.4	17,200	<22.4	<22.4	<22.4	<22.4	<22.4	<22.4	<22.4	<22.4	<22.4	4,600	20,000	600,000	40,000,000
Naphthalene	µg/kg	<24.9	(1,500)	<24.9	59 "J"	<24.9	(3,140)	<24.9	<24.9	<24.9	<24.9	<24.9	<24.9	<24.9	<24.9	<24.9	(400)	400	20,000	110,000
Phenanthrene	µg/kg	<22	286	<22	53 "J"	<22	(2,740)	<22	<22	<22	<22	<22	<22	<22	68 "J"	<22	1,350	1,800	18,000	390,000
Pyrene	µg/kg	<20.7	36 "J"	<20.7	440	<20.7	182 "J"	<20.7	<20.7	<20.7	<20.7	<20.7	<20.7	<20.7	76	<20.7	149	8,700,000	500,000	30,000,000

Notes:

- µg/kg = micrograms per kilogram (equivalent to parts per billion, ppb)
- mg/kg = milligrams per kilogram (equivalent to parts per million, ppm)
- NA = not analyzed
- GW RCLs = Groundwater Residual Contaminant Levels based on the following:
 For petroleum hydrocarbons, GW RCLs based on Wisconsin Administrative Code, Chapter NR 720.09 generic Residual Contaminant Levels for protection of groundwater.
 For PAHs, GW RCLs based on interim guidance RCL for protection of groundwater pathway from PAH compounds, from WDNR publication RR-519-97 "Soil Cleanup Levels for Polycyclic Aromatic Hydrocarbons (PAHs) Interim"
- DC RCLs for Non-Industrial Soil = Direct Contact Residual Contaminant Levels based on the following:
 For petroleum hydrocarbons, DC RCLs based on Wisconsin Administrative Code, Chapter NR 746.06 Table 1 ("Indicators of Residual Petroleum Product in Soil Pores") soil screening levels / Table 2 ("Protection of Human Health from Direct Contact with Contaminated Soil") concentrations.
 For PAHs, DC RCLs based on interim guidance RCL for protection of direct contact with PAH compounds for non-industrial land use, from WDNR publication RR-519-97 "Soil Cleanup Levels for Polycyclic Aromatic Hydrocarbons (PAHs) Interim Guidance" (April 1997)
- DC RCLs for Industrial Soil = Direct Contact Residual Contaminant Levels based on the following:
 For PAHs, DC RCLs based on interim guidance RCL for protection of direct contact with PAH compounds for industrial land use, from WDNR publication RR-519-97 "Soil Cleanup Levels for Polycyclic Aromatic Hydrocarbons (PAHs) Interim Guidance" (April 1997)
- NS = no standard established
- Laboratory flags: "J" = Analyte detected between Limit of Detection and Limit of Quantitation
- Exceedances: () = Concentration exceeds GW RCL
 { } = Concentration exceeds DC RCL for Non-Industrial Soil
 [] = Concentration exceeds DC RCL for Industrial Soil

Table 3
Groundwater Quality Results
Jacobus Bulk Plant / Retail Station (Former) - 111 E. Decorah Road, West Bend, Wisconsin
Project Reference #6662

Sample Location:	MW-1																							NR 140 ES	NR 140 PAL	
	Sample Date:	12/17/91	6/9/94	9/14/94	12/8/94	8/29/95	4/10/96	8/8/96	10/24/96	6/18/97	11/19/98	5/20/99	11/10/99	12/19/01	3/17/03	3/03 Dup 2	12/30/03	12/03 Dup 1	4/13/06	2/25/09	3/21/11	8/4/11	11/4/11			6/7/12
PVOCs	Units																									
Benzene	µg/l	[10,000]	[850]	[970]	[660]	[550]	[38]	[1,070]	[490]	[450]	[220]	[150]	[90]	[36]	[32.2]	34.4	[9.74]	6.55	[13]	[11]	<6.3	[11 "J"]	<4.0	<10	5	0.5
Ethylbenzene	µg/l	[4,000]	[660]	[520]	[480]	[590]	35	[2,350]	[524]	[700]	[420]	[800]	[750]	[390]	[667]	654	[230]	222	[720]	[1,300]	[890]	[1,300]	[420]	[870]	700	140
Methyl tert Butyl Ether	µg/l	ND	<100	<100	<100	<100	<100	<100	<100	<15	<4.0	(20)	<10	<2.6	<10.0	<10.0	3.34	1.21	<10	<2.3	<5.8	<4.6	<3.7	<16	60	12
Toluene	µg/l	[16,000]	[3,700]	[3,500]	[2,100]	[1,500]	3.9	[15,300]	(510)	[1,600]	42	[1,300]	[950]	35	<25.0	25.0	59.2	58.4	(340)	(370)	(370)	94	22 "J"	56	800	160
1,2,4-Trimethylbenzene	µg/l	2,400	290	430	140	200	18	1,640	209	500	190	600	500	230	313	298	143	124	1,200	1,400	1,400	1,300	860	1,200	NS	NS
1,3,5-Trimethylbenzene	µg/l	730	100	110	88	45	3.1	468	59	140	94	160	180	52	54.2	57.2	18.6	19.7	320	280	170	150	78	106	NS	NS
Total Trimethylbenzene	µg/l	[3,130]	(390)	[540]	(228)	(245)	21.1	[2,108]	(268)	[640]	(284)	[760]	[680]	(282)	(367.2)	355.2	(161.6)	143.7	[1,520]	[1,680]	[1,570]	[1,450]	[938]	[1,306]	480	96
Total Xylenes	µg/l	[22,900]	[2,620]	[3,310]	(1,340)	(1,770)	45.4	[18,170]	(1,305)	[3,500]	(750)	[3,800]	[4,000]	(730)	(698)	692	298	282	[4,400]	[7,000]	[4,300]	[5,000]	[2,600]	[3,390]	2,000	400
Detected VOCs																										
n-Butylbenzene	µg/l	NA	NA	NA	NA	NA	NA	NA	NA	NA	NA	NA	NA	NA	NA	NA	NA	NA	NA	NA	NA	NA	NA	NA	NS	NS
Chloroform	µg/l	NA	NA	NA	NA	NA	NA	NA	NA	NA	NA	NA	NA	NA	NA	NA	NA	NA	NA	NA	NA	NA	NA	NA	6	0.6
Chloromethane	µg/l	NA	NA	NA	NA	NA	NA	NA	NA	NA	NA	NA	NA	NA	NA	NA	NA	NA	NA	NA	NA	NA	NA	NA	30	3
Isopropylbenzene	µg/l	NA	NA	NA	NA	NA	NA	NA	NA	NA	NA	NA	NA	NA	NA	NA	NA	NA	NA	NA	NA	NA	NA	NA	NS	NS
Methylene Chloride	µg/l	NA	NA	NA	NA	NA	NA	NA	NA	NA	NA	NA	NA	NA	NA	NA	NA	NA	NA	NA	NA	NA	NA	NA	5	0.5
n-Propylbenzene	µg/l	NA	NA	NA	NA	NA	NA	NA	NA	NA	NA	NA	NA	NA	NA	NA	NA	NA	NA	NA	NA	NA	NA	NA	NS	NS
Naphthalene	µg/l	NA	NA	NA	NA	NA	NA	NA	NA	NA	NA	NA	NA	NA	NA	NA	(42.3)	NA	[140]	[200]	[140]	[220]	[110]	[134 "J"]	100	10
Dissolved Metals																										
Lead	µg/l	NA	NA	NA	NA	NA	NA	NA	NA	NA	NA	NA	NA	NA	NA	NA	NA	NA	NA	NA	NA	NA	NA	NA	15	1.5

Notes:

- µg/l = micrograms per liter (equivalent to parts per billion, ppb)
- NR 140 ES = Wisconsin Administrative Code, Chapter NR 140 Enforcement Standard
- NR 140 PAL = Wisconsin Administrative Code, Chapter NR 140 Preventive Action Limit
- FP = Free Product in well - no sample collected
- Laboratory flags:
 - "L" = Concentration flagged by laboratory as common lab solvent and contaminant
 - "J" = Concentration reported between Method Detection Limit and Limit of Quantitation
 - "Q" = Unquantitated hydrocarbons present in the sample outside of the reported carbon range (lab indicated these are late end petroleum hydrocarbon peaks)
- Exceedances:
 - [] = Concentration exceeds NR 140 ES
 - () = Concentration exceeds NR 140 PAL
- Trip blank results:
 - 12/19/01 - All PVOCs reported below laboratory detection limits
 - 3/17/03 - All PVOCs reported below laboratory detection limits
 - 12/30/03 - All PVOCs reported below laboratory detection limits
 - 4/13/06 - All PVOCs reported below laboratory detection limits
 - 2/25/09 & 2/26/09 - All PVOCs reported below laboratory detection limits
 - 3/21/11 - All PVOCs reported below laboratory detection limits
 - 8/4/11 - All PVOCs reported below laboratory detection limits
 - 11/4/11 - All PVOCs reported below laboratory detection limits
 - 6/7/12 - All PVOCs reported below laboratory detection limits
- Equipment blank results:
 - 12/19/01 - All PVOCs reported below laboratory detection limits, except for toluene reported at 0.22 µg/l in 1 blank (2 equipment blanks used this event)
 - 3/17/03 - All PVOCs reported below laboratory detection limits
 - 12/30/03 - Not used, as new disposable bailers used at each well to collect groundwater samples
 - 4/13/06 - All PVOCs reported below laboratory detection limits, except benzene (1.3 µg/L) and toluene (0.62 µg/L). Benzene was not detected at low levels in any samples, but toluene was detected at low levels in well MW-15.
 - 2/25/09 & 2/26/09 - All PVOCs reported below laboratory detection limits
 - 3/21/11 - All PVOCs reported below laboratory detection limits
 - 8/4/11 - All PVOCs reported below laboratory detection limits, except toluene (0.47 "J" µg/L). Toluene was not detected at this low of level in any samples.
 - 11/4/11 - All PVOCs reported below laboratory detection limits
 - 6/7/12 - All PVOCs reported below laboratory detection limits

Table 3
Groundwater Quality Results
Jacobus Bulk Plant / Retail Station (Former) - 111 E. Decorah Road, West Bend, Wisconsin
Project Reference #6662

Sample Location:		MW-2																									NR 140	NR 140		
Sample Date:		12/17/91	7/28/93	9/29/93	12/30/93	3/24/94	6/9/94	9/14/94	12/8/94	8/29/95	4/10/96	8/8/96	10/24/96	6/18/97	11/19/98	5/20/99	11/10/99	12/19/01	12/01 Dup 2	3/17/03	12/30/03	4/13/06	2/25/09	3/21/11	8/4/11	11/4/11	6/7/12	ES	PAL	
PVOcs																														
	Units																													
Benzene	µg/l	ND	[56]	(3.2)	ND	ND	ND	ND	ND	ND	ND	ND	ND	ND	ND	ND	ND	<0.13	<0.13	<0.500	<0.500	<0.20	<0.25	<0.25	NA	<0.25	<0.5	5	0.5	
Ethylbenzene	µg/l	ND	100	6.6	2	ND	ND	ND	ND	ND	ND	ND	ND	ND	ND	ND	ND	0.43	0.44	<0.500	<5.00	<0.50	<0.22	<0.22	NA	<0.22	<0.78	700	140	
Methyl tert Butyl Ether	µg/l	ND	ND	ND	ND	ND	ND	ND	ND	ND	ND	ND	ND	ND	ND	ND	ND	<0.58	<0.16	<0.200	<0.146	<0.50	<0.23	<0.23	NA	<0.23	<0.8	60	12	
Toluene	µg/l	ND	(500)	6.9	ND	ND	ND	0.56	ND	ND	ND	11	0.3	ND	ND	ND	ND	<0.20	<0.20	<0.500	<5.00	<0.20	<0.25	<0.25	NA	<0.25	<0.53	800	160	
1,2,4-Trimethylbenzene	µg/l	ND	77	3.8	ND	ND	ND	ND	ND	ND	ND	ND	ND	ND	ND	ND	ND	1.8	1.8	<1.00	<5.00	<0.20	<0.25	<0.25	NA	0.32 "J"	<0.8	NS	NS	
1,3,5-Trimethylbenzene	µg/l	ND	21	2	ND	ND	ND	ND	ND	ND	ND	0.9	ND	ND	ND	ND	ND	1.0	0.97	<1.00	<5.00	<0.20	<0.19	<0.19	NA	0.36 "J"	<0.74	NS	NS	
Total Trimethylbenzene	µg/l	ND	(98)	5.8	ND	ND	ND	ND	ND	ND	ND	0.9	ND	ND	ND	ND	ND	2.8	2.77	<2.00	<10.00	<0.40	<0.44	<0.44	NA	0.68 "J"	<1.54	480	96	
Total Xylenes	µg/l	ND	(560)	23.9	3	ND	ND	ND	ND	ND	ND	16.3	0.8	ND	ND	ND	1.1	6.0	5.7	<0.500	<5.00	<0.50	<0.39	<0.39	NA	<0.39	<1.9	2,000	400	
Detected VOCs																														
n-Butylbenzene	µg/l	NA	NA	NA	NA	NA	NA	NA	NA	NA	NA	NA	NA	NA	NA	NA	NA	NA	NA	NA	NA	NA	NA	NA	NA	NA	NA	NA	NS	NS
Chloroform	µg/l	NA	NA	NA	NA	NA	NA	NA	NA	NA	NA	NA	NA	NA	NA	NA	NA	NA	NA	NA	NA	NA	NA	NA	NA	NA	NA	NA	6	0.6
Chloromethane	µg/l	NA	NA	NA	NA	NA	NA	NA	NA	NA	NA	NA	NA	NA	NA	NA	NA	NA	NA	NA	NA	NA	NA	NA	NA	NA	NA	NA	30	3
Isopropylbenzene	µg/l	NA	NA	NA	NA	NA	NA	NA	NA	NA	NA	NA	NA	NA	NA	NA	NA	NA	NA	NA	NA	NA	NA	NA	NA	NA	NA	NA	NS	NS
Methylene Chloride	µg/l	NA	NA	NA	NA	NA	NA	NA	NA	NA	NA	NA	NA	NA	NA	NA	NA	NA	NA	NA	NA	NA	NA	NA	NA	NA	NA	NA	5	0.5
n-Propylbenzene	µg/l	NA	NA	NA	NA	NA	NA	NA	NA	NA	NA	NA	NA	NA	NA	NA	NA	NA	NA	NA	NA	NA	NA	NA	NA	NA	NA	NA	NS	NS
Naphthalene	µg/l	NA	NA	NA	NA	NA	NA	NA	NA	NA	NA	NA	NA	NA	NA	NA	NA	NA	NA	NA	<8.00	<0.25	<0.50	<0.50	NA	0.60 "J"	<2.1	100	10	
Dissolved Metals																														
Lead	µg/l	NA	NA	NA	NA	NA	NA	NA	NA	NA	NA	NA	NA	NA	NA	NA	NA	NA	NA	NA	NA	NA	NA	NA	NA	NA	NA	NA	15	1.5

Notes:

- µg/l = micrograms per liter (equivalent to parts per billion, ppb)
- NR 140 ES = Wisconsin Administrative Code, Chapter NR 140 Enforcement Standard
- NR 140 PAL = Wisconsin Administrative Code, Chapter NR 140 Preventive Action Limit
- FP = Free Product in well - no sample collected
- Laboratory flags:
 - "L" = Concentration flagged by laboratory as common lab solvent and contaminant
 - "J" = Concentration reported between Method Detection Limit and Limit of Quantitation
 - "Q" = Unquantitated hydrocarbons present in the sample outside of the reported carbon range (lab indicated these are late end petroleum hydrocarbon peaks)
- Exceedances:
 - [] = Concentration exceeds NR 140 ES
 - () = Concentration exceeds NR 140 PAL
- Trip blank results:
 - 12/19/01 - All PVOcs reported below laboratory detection limits
 - 3/17/03 - All PVOcs reported below laboratory detection limits
 - 12/30/03 - All PVOcs reported below laboratory detection limits
 - 4/13/06 - All PVOcs reported below laboratory detection limits
 - 2/25/09 & 2/26/09 - All PVOcs reported below laboratory detection limits
 - 3/21/11 - All PVOcs reported below laboratory detection limits
 - 8/4/11 - All PVOcs reported below laboratory detection limits
 - 11/4/11 - All PVOcs reported below laboratory detection limits
 - 6/7/12 - All PVOcs reported below laboratory detection limits
- Equipment blank results:
 - 12/19/01 - All PVOcs reported below laboratory detection limits, except for toluene reported at 0.22 µg/l in 1 blank (2 equipment blanks used this event)
 - 3/17/03 - All PVOcs reported below laboratory detection limits
 - 12/30/03 - Not used, as new disposable bailers used at each well to collect groundwater samples
 - 4/13/06 - All PVOcs reported below laboratory detection limits, except benzene (1.3 µg/L) and toluene (0.62 µg/L). Benzene was not detected at low levels in any samples, but toluene was detected at low levels in well MW-15.
 - 2/25/09 & 2/26/09 - All PVOcs reported below laboratory detection limits
 - 3/21/11 - All PVOcs reported below laboratory detection limits
 - 8/4/11 - All PVOcs reported below laboratory detection limits, except toluene (0.47 "J" µg/L). Toluene was not detected at this low level in any samples.
 - 11/4/11 - All PVOcs reported below laboratory detection limits
 - 6/7/12 - All PVOcs reported below laboratory detection limits

Table 3 Groundwater Quality Results Jacobus Bulk Plant / Retail Station (Former) - 111 E. Decorah Road, West Bend, Wisconsin Project Reference #6662															
Sample Location:		MW-3											NR 140	NR 140	
Sample Date:		12/17/91	12/19/01	3/17/03	12/30/03	4/13/06	2/25/09	3/21/11	8/4/11	11/4/11	11/11 Dup.	6/7/12	ES	PAL	
PVOCs		Units													
Benzene	µg/l	[33,000]	FP	FP	FP	FP	FP / [420]	[250]	[340 "J"]	FP / [270 "J"]	400	[216 "J"]	5	0.5	
Ethylbenzene	µg/l	[4,300]	FP	FP	FP	FP	FP / [3,500]	[2,300]	[2,600]	FP / [2,500]	5,200	[2,060]	700	140	
Methyl tert Butyl Ether	µg/l	ND	FP	FP	FP	FP	FP / <2.3	<9.2	<120	FP / <92	<23	<160	60	12	
Toluene	µg/l	[70,000]	FP	FP	FP	FP	FP / [35,000]	(580)	[29,000]	FP / [23,000]	25,000	[20,600]	800	160	
1,2,4-Trimethylbenzene	µg/l	2,600	FP	FP	FP	FP	FP / 1,600	2,400	2,300	FP / 2,400	10,000	1,700	NS	NS	
1,3,5-Trimethylbenzene	µg/l	570	FP	FP	FP	FP	FP / 510	790	910 "J"	FP / 1,000	4,600	670	NS	NS	
Total Trimethylbenzene	µg/l	[3,170]	FP	FP	FP	FP	FP / [2,110]	[3,190]	[3,210]	FP / [3,400]	14,600	[2,370]	480	96	
Total Xylenes	µg/l	[24,200]	FP	FP	FP	FP	FP / [23,000]	[19,000]	[20,000]	FP / [22,000]	43,000	[16,500]	2,000	400	
Detected VOCs															
n-Butylbenzene	µg/l	NA	NA	NA	NA	NA	NA	NA	NA	NA	NA	NA	NA	NS	NS
Chloroform	µg/l	NA	NA	NA	NA	NA	NA	NA	NA	NA	NA	NA	NA	6	0.6
Chloromethane	µg/l	NA	NA	NA	NA	NA	NA	NA	NA	NA	NA	NA	NA	30	3
Isopropylbenzene	µg/l	NA	NA	NA	NA	NA	NA	NA	NA	NA	NA	NA	NA	NS	NS
Methylene Chloride	µg/l	NA	NA	NA	NA	NA	NA	NA	NA	NA	NA	NA	NA	5	0.5
n-Propylbenzene	µg/l	NA	NA	NA	NA	NA	NA	NA	NA	NA	NA	NA	NA	NS	NS
Naphthalene	µg/l	NA	NA	NA	FP	FP	FP / [290]	[380]	[690 "J"]	FP / [590 "J"]	NA	[610 "J"]	100	10	
Dissolved Metals															
Lead	µg/l	NA	NA	NA	NA	NA	NA	(5.1)	NA	NA	NA	NA	15	1.5	

Notes:

- µg/l = micrograms per liter (equivalent to parts per billion, ppb)
- NR 140 ES = Wisconsin Administrative Code, Chapter NR 140 Enforcement Standard
- NR 140 PAL = Wisconsin Administrative Code, Chapter NR 140 Preventive Action Limit
- FP = Free Product in well - no sample collected
- Laboratory flags:
 - "L" = Concentration flagged by laboratory as common lab solvent and contaminant
 - "J" = Concentration reported between Method Detection Limit and Limit of Quantitation
 - "Q" = Unquantitated hydrocarbons present in the sample outside of the reported carbon range (lab indicated these are late end petroleum hydrocarbon peaks)
- Exceedances:
 - [] = Concentration exceeds NR 140 ES
 - () = Concentration exceeds NR 140 PAL
- Trip blank results:
 - 12/19/01 - All PVOCs reported below laboratory detection limits
 - 3/17/03 - All PVOCs reported below laboratory detection limits
 - 12/30/03 - All PVOCs reported below laboratory detection limits
 - 4/13/06 - All PVOCs reported below laboratory detection limits
 - 2/25/09 & 2/26/09 - All PVOCs reported below laboratory detection limits
 - 3/21/11 - All PVOCs reported below laboratory detection limits
 - 8/4/11 - All PVOCs reported below laboratory detection limits
 - 11/4/11 - All PVOCs reported below laboratory detection limits
 - 6/7/12 - All PVOCs reported below laboratory detection limits
- Equipment blank results:
 - 12/19/01 - All PVOCs reported below laboratory detection limits, except for toluene reported at 0.22 µg/l in 1 blank (2 equipment blanks used this event)
 - 3/17/03 - All PVOCs reported below laboratory detection limits
 - 12/30/03 - Not used, as new disposable bailers used at each well to collect groundwater samples
 - 4/13/06 - All PVOCs reported below laboratory detection limits, except benzene (1.3 µg/L) and toluene (0.62 µg/L). Benzene was not detected at low levels in any samples, but toluene was detected at low levels in well MW-15.
 - 2/25/09 & 2/26/09 - All PVOCs reported below laboratory detection limits
 - 3/21/11 - All PVOCs reported below laboratory detection limits
 - 8/4/11 - All PVOCs reported below laboratory detection limits, except toluene (0.47 "J" µg/L). Toluene was not detected at this low of level in any samples.
 - 11/4/11 - All PVOCs reported below laboratory detection limits
 - 6/7/12 - All PVOCs reported below laboratory detection limits

Table 3
Groundwater Quality Results
Jacobus Bulk Plant / Retail Station (Former) - 111 E. Decorah Road, West Bend, Wisconsin
Project Reference #6662

Sample Location:		MW-4													NR 140	NR 140	
Sample Date:		12/18/91	6/18/97	11/19/98	5/20/99	12/19/01	3/17/03	12/30/03	4/13/06	2/25/09	3/21/11	8/4/11	11/4/11	6/7/12	ES	PAL	
PVOCs																	
	Units																
Benzene	µg/l	[21,000]	[600]	[350]	<200	FP	FP	FP	FP	FP / [25 "J"]	FP / <13	FP / <13	FP / <13	FP / <100	5	0.5	
Ethylbenzene	µg/l	[3,700]	[2,300]	[2,500]	[7,000]	FP	FP	FP	FP	FP / [1,100]	FP / (660)	FP / [830]	FP / [1,300]	FP / [1,410]	700	140	
Methyl tert Butyl Ether	µg/l	[300]	ND	ND	<200	FP	FP	FP	FP	FP / <9.2	FP / <12	FP / <12	FP / <12	FP / <160	60	12	
Toluene	µg/l	[53,000]	[8,500]	[6,400]	[10,000]	FP	FP	FP	FP	FP / [900]	FP / (230)	FP / (220)	FP / (270)	FP / (174 "J")	800	160	
1,2,4-Trimethylbenzene	µg/l	1,800	2,200	2,900	60,000	FP	FP	FP	FP	FP / 3,400	FP / 3,500	FP / 3,900	FP / 4,100	FP / 4,700	NS	NS	
1,3,5-Trimethylbenzene	µg/l	530	630	2,700	20,000	FP	FP	FP	FP	FP / 1,100	FP / 1,100	FP / 1,300	FP / 1,400	FP / 1,740	NS	NS	
Total Trimethylbenzene	µg/l	[2,330]	[2,830]	[5,600]	[80,000]	FP	FP	FP	FP	FP / [4,500]	FP / [4,600]	FP / [5,200]	FP / [5,500]	FP / [6,440]	480	96	
Total Xylenes	µg/l	[20,200]	[12,900]	[21,600]	[67,000]	FP	FP	FP	FP	FP / [18,000]	FP / [15,000]	FP / [12,000]	FP / [14,000]	FP / [10,660]	2,000	400	
Detected VOCs																	
n-Butylbenzene	µg/l	NA	NA	NA	NA	NA	NA	NA	NA	NA	NA	NA	NA	NA	NS	NS	
Chloroform	µg/l	NA	NA	NA	NA	NA	NA	NA	NA	NA	NA	NA	NA	NA	6	0.6	
Chloromethane	µg/l	NA	NA	NA	NA	NA	NA	NA	NA	NA	NA	NA	NA	NA	30	3	
Isopropylbenzene	µg/l	NA	NA	NA	NA	NA	NA	NA	NA	NA	NA	NA	NA	NA	NS	NS	
Methylene Chloride	µg/l	NA	NA	NA	NA	NA	NA	NA	NA	NA	NA	NA	NA	NA	5	0.5	
n-Propylbenzene	µg/l	NA	NA	NA	NA	NA	NA	NA	NA	NA	NA	NA	NA	NA	NS	NS	
Naphthalene	µg/l	NA	NA	NA	NA	NA	NA	FP	FP	FP / [660]	FP / [710]	FP / [1,000]	FP / [950]	FP / [1,090 "J"]	100	10	
Dissolved Metals																	
Lead	µg/l	NA	NA	NA	NA	NA	NA	NA	NA	NA	NA	FP / (6.5)	NA	NA	NA	15	1.5

Notes:

- µg/l = micrograms per liter (equivalent to parts per billion, ppb)
- NR 140 ES = Wisconsin Administrative Code, Chapter NR 140 Enforcement Standard
- NR 140 PAL = Wisconsin Administrative Code, Chapter NR 140 Preventive Action Limit
- FP = Free Product in well - no sample collected
- Laboratory flags:
 - "L" = Concentration flagged by laboratory as common lab solvent and contaminant
 - "J" = Concentration reported between Method Detection Limit and Limit of Quantitation
 - "Q" = Unquantitated hydrocarbons present in the sample outside of the reported carbon range (lab indicated these are late end petroleum hydrocarbon peaks)
- Exceedances:
 - [] = Concentration exceeds NR 140 ES
 - () = Concentration exceeds NR 140 PAL
- Trip blank results:
 - 12/19/01 - All PVOCs reported below laboratory detection limits
 - 3/17/03 - All PVOCs reported below laboratory detection limits
 - 12/30/03 - All PVOCs reported below laboratory detection limits
 - 4/13/06 - All PVOCs reported below laboratory detection limits
 - 2/25/09 & 2/26/09 - All PVOCs reported below laboratory detection limits
 - 3/21/11 - All PVOCs reported below laboratory detection limits
 - 8/4/11 - All PVOCs reported below laboratory detection limits
 - 11/4/11 - All PVOCs reported below laboratory detection limits
 - 6/7/12 - All PVOCs reported below laboratory detection limits
- Equipment blank results:
 - 12/19/01 - All PVOCs reported below laboratory detection limits, except for toluene reported at 0.22 µg/l in 1 blank (2 equipment blanks used this event)
 - 3/17/03 - All PVOCs reported below laboratory detection limits
 - 12/30/03 - Not used, as new disposable bailers used at each well to collect groundwater samples
 - 4/13/06 - All PVOCs reported below laboratory detection limits, except benzene (1.3 µg/L) and toluene (0.62 µg/L). Benzene was not detected at low levels in any samples, but toluene was detected at low levels in well MW-15.
 - 2/25/09 & 2/26/09 - All PVOCs reported below laboratory detection limits
 - 3/21/11 - All PVOCs reported below laboratory detection limits
 - 8/4/11 - All PVOCs reported below laboratory detection limits, except toluene (0.47 "J" µg/L). Toluene was not detected at this low level in any samples.
 - 11/4/11 - All PVOCs reported below laboratory detection limits
 - 6/7/12 - All PVOCs reported below laboratory detection limits

Table 3 Groundwater Quality Results Jacobus Bulk Plant / Retail Station (Former) - 111 E. Decorah Road, West Bend, Wisconsin Project Reference #6662															
Sample Location:		MW-5											NR 140	NR 140	
Sample Date:		12/18/91	12/19/01	3/17/03	12/30/03	4/13/06	2/26/09	3/21/11	8/4/11	8/11 Dup	11/4/11	6/7/12	ES	PAL	
PVOCs		Units													
Benzene	µg/l	[22,000]	FP	FP	FP	FP	FP / [910]	FP / [600]	FP / [630]	630	FP / [520]	FP / [400]	5	0.5	
Ethylbenzene	µg/l	[3,200]	FP	FP	FP	FP	FP / [2,500]	FP / [2,500]	FP / [2,500]	2,800	FP / [2,600]	FP / [2,090]	700	140	
Methyl tert Butyl Ether	µg/l	ND	FP	FP	FP	FP	FP / <18	FP / <46	FP / <46	<46	FP / <23	FP / <80	60	12	
Toluene	µg/l	[49,000]	FP	FP	FP	FP	FP / [12,000]	FP / [12,000]	FP / [11,000]	12,000	FP / [11,000]	FP / [9,900]	800	160	
1,2,4-Trimethylbenzene	µg/l	1,500	FP	FP	FP	FP	FP / 1,800	FP / 1,800	FP / 2,600	4,200	FP / 2,700	FP / 1,420	NS	NS	
1,3,5-Trimethylbenzene	µg/l	450	FP	FP	FP	FP	FP / 460	FP / 470	FP / 690	1,100	FP / 730	FP / 360	NS	NS	
Total Trimethylbenzene	µg/l	[1,950]	FP	FP	FP	FP	FP / [2,260]	FP / [2,270]	FP / [3,290]	5,300	FP / [3,430]	FP / [1,780]	480	96	
Total Xylenes	µg/l	[18,600]	FP	FP	FP	FP	FP / [14,000]	FP / [15,000]	FP / [15,000]	17,000	FP / [16,000]	FP / [11,900]	2,000	400	
Detected VOCs															
n-Butylbenzene	µg/l	NA	NA	NA	NA	NA	NA	NA	NA	NA	NA	NA	NA	NS	NS
Chloroform	µg/l	NA	NA	NA	NA	NA	NA	NA	NA	NA	NA	NA	NA	6	0.6
Chloromethane	µg/l	NA	NA	NA	NA	NA	NA	NA	NA	NA	NA	NA	NA	30	3
Isopropylbenzene	µg/l	NA	NA	NA	NA	NA	NA	NA	NA	NA	NA	NA	NA	NS	NS
Methylene Chloride	µg/l	NA	NA	NA	NA	NA	NA	NA	NA	NA	NA	NA	NA	5	0.5
n-Propylbenzene	µg/l	NA	NA	NA	NA	NA	NA	NA	NA	NA	NA	NA	NA	NS	NS
Naphthalene	µg/l	NA	NA	NA	FP	FP	FP / [570]	FP / [640]	FP / [980]	NA	FP / [870]	FP / [530 "J"]	100	10	
Dissolved Metals															
Lead	µg/l	NA	NA	NA	NA	NA	NA	FP / 0.96	NA	NA	NA	NA	15	1.5	

Notes:

- µg/l = micrograms per liter (equivalent to parts per billion, ppb)
- NR 140 ES = Wisconsin Administrative Code, Chapter NR 140 Enforcement Standard
- NR 140 PAL = Wisconsin Administrative Code, Chapter NR 140 Preventive Action Limit
- FP = Free Product in well - no sample collected
- Laboratory flags:
 - "L" = Concentration flagged by laboratory as common lab solvent and contaminant
 - "J" = Concentration reported between Method Detection Limit and Limit of Quantitation
 - "Q" = Unquantitated hydrocarbons present in the sample outside of the reported carbon range (lab indicated these are late end petroleum hydrocarbon peaks)
- Exceedances:
 - [] = Concentration exceeds NR 140 ES
 - () = Concentration exceeds NR 140 PAL
- Trip blank results:
 - 12/19/01 - All PVOCs reported below laboratory detection limits
 - 3/17/03 - All PVOCs reported below laboratory detection limits
 - 12/30/03 - All PVOCs reported below laboratory detection limits
 - 4/13/06 - All PVOCs reported below laboratory detection limits
 - 2/25/09 & 2/26/09 - All PVOCs reported below laboratory detection limits
 - 3/21/11 - All PVOCs reported below laboratory detection limits
 - 8/4/11 - All PVOCs reported below laboratory detection limits
 - 11/4/11 - All PVOCs reported below laboratory detection limits
 - 6/7/12 - All PVOCs reported below laboratory detection limits
- Equipment blank results:
 - 12/19/01 - All PVOCs reported below laboratory detection limits, except for toluene reported at 0.22 µg/l in 1 blank (2 equipment blanks used this event)
 - 3/17/03 - All PVOCs reported below laboratory detection limits
 - 12/30/03 - Not used, as new disposable bailers used at each well to collect groundwater samples
 - 4/13/06 - All PVOCs reported below laboratory detection limits, except benzene (1.3 µg/L) and toluene (0.62 µg/L). Benzene was not detected at low levels in any samples, but toluene was detected at low levels in well MW-15.
 - 2/25/09 & 2/26/09 - All PVOCs reported below laboratory detection limits
 - 3/21/11 - All PVOCs reported below laboratory detection limits
 - 8/4/11 - All PVOCs reported below laboratory detection limits, except toluene (0.47 "J" µg/L). Toluene was not detected at this low of level in any samples.
 - 11/4/11 - All PVOCs reported below laboratory detection limits
 - 6/7/12 - All PVOCs reported below laboratory detection limits

Table 3 Groundwater Quality Results Jacobus Bulk Plant / Retail Station (Former) - 111 E. Decorah Road, West Bend, Wisconsin Project Reference #6662																	
Sample Location:		MW-6													MW-6R	NR 140	NR 140
Sample Date:		12/18/91	6/18/97	11/20/98	5/20/99	12/19/01	3/17/03	12/30/03	4/13/06	2/26/09	3/21/11	8/4/11	11/4/11	6/7/12	ES	PAL	
PVOCs		Units															
Benzene	µg/l	[570]	[220]	[190]	[130]	FP	FP	FP	FP	FP / [40 "Q"]	<1.3 "Q"	FP / [37]	Well	[17.2]	5	0.5	
Ethylbenzene	µg/l	(140)	91	130	34	FP	FP	FP	FP	FP / 42 "Q"	13 "Q"	FP / 44	abandoned	(450)	700	140	
Methyl tert Butyl Ether	µg/l	ND	ND	ND	<4.0	FP	FP	FP	FP	FP / <1.2 "Q"	<1.2 "Q"	FP / <2.3	by	<8	60	12	
Toluene	µg/l	97	30	55	4.0	FP	FP	FP	FP	FP / 19 "Q"	<1.3 "Q"	FP / 18 "J"	removal	158	800	160	
1,2,4-Trimethylbenzene	µg/l	210	87	90	100	FP	FP	FP	FP	FP / 70 "Q"	140 "Q"	FP / 200	on 10/6/11	420	NS	NS	
1,3,5-Trimethylbenzene	µg/l	52	26	27	32	FP	FP	FP	FP	FP / 39 "Q"	69 "Q"	FP / 93	during	117	NS	NS	
Total Trimethylbenzene	µg/l	(262)	(113)	(117)	(132)	FP	FP	FP	FP	FP / (109)	(209)	FP / (293)	UST	[537]	480	96	
Total Xylenes	µg/l	(600)	265	(401)	190	FP	FP	FP	FP	FP / 170 "Q"	100 "Q"	FP / 250	removal.	[2,100]	2,000	400	
Detected VOCs																	
n-Butylbenzene	µg/l	NA	NA	NA	NA	NA	NA	NA	NA	NA	NA	NA	NA	17.4 "J"	NS	NS	
Chloroform	µg/l	NA	NA	NA	NA	NA	NA	NA	NA	NA	NA	NA	NA	<4.9	6	0.6	
Chloromethane	µg/l	NA	NA	NA	NA	NA	NA	NA	NA	NA	NA	NA	NA	<19	30	3	
Isopropylbenzene	µg/l	NA	NA	NA	NA	NA	NA	NA	NA	NA	NA	NA	NA	19.9 "J"	NS	NS	
Methylene Chloride	µg/l	NA	NA	NA	NA	NA	NA	NA	NA	NA	NA	NA	NA	<11	5	0.5	
n-Propylbenzene	µg/l	NA	NA	NA	NA	NA	NA	NA	NA	NA	NA	NA	NA	40	NS	NS	
Naphthalene	µg/l	NA	NA	NA	NA	NA	NA	FP	FP	FP / [110 "Q"]	[160 "Q"]	FP / [370]	NA	[370]	100	10	
Dissolved Metals																	
Lead	µg/l	NA	NA	NA	NA	NA	NA	NA	NA	NA	NA	0.35 "J"	NA	NA	NA	15	1.5

Notes:

- µg/l = micrograms per liter (equivalent to parts per billion, ppb)
- NR 140 ES = Wisconsin Administrative Code, Chapter NR 140 Enforcement Standard
- NR 140 PAL = Wisconsin Administrative Code, Chapter NR 140 Preventive Action Limit
- FP = Free Product in well - no sample collected
- Laboratory flags:
 - "L" = Concentration flagged by laboratory as common lab solvent and contaminant
 - "J" = Concentration reported between Method Detection Limit and Limit of Quantitation
 - "Q" = Unquantitated hydrocarbons present in the sample outside of the reported carbon range (lab indicated these are late end petroleum hydrocarbon peaks)
- Exceedances:
 - [] = Concentration exceeds NR 140 ES
 - () = Concentration exceeds NR 140 PAL
- Trip blank results:
 - 12/19/01 - All PVOCs reported below laboratory detection limits
 - 3/17/03 - All PVOCs reported below laboratory detection limits
 - 12/30/03 - All PVOCs reported below laboratory detection limits
 - 4/13/06 - All PVOCs reported below laboratory detection limits
 - 2/25/09 & 2/26/09 - All PVOCs reported below laboratory detection limits
 - 3/21/11 - All PVOCs reported below laboratory detection limits
 - 8/4/11 - All PVOCs reported below laboratory detection limits
 - 11/4/11 - All PVOCs reported below laboratory detection limits
 - 6/7/12 - All PVOCs reported below laboratory detection limits
- Equipment blank results:
 - 12/19/01 - All PVOCs reported below laboratory detection limits, except for toluene reported at 0.22 µg/l in 1 blank (2 equipment blanks used this event)
 - 3/17/03 - All PVOCs reported below laboratory detection limits
 - 12/30/03 - Not used, as new disposable bailers used at each well to collect groundwater samples
 - 4/13/06 - All PVOCs reported below laboratory detection limits, except benzene (1.3 µg/L) and toluene (0.62 µg/L). Benzene was not detected at low levels in any samples, but toluene was detected at low levels in well MW-15.
 - 2/25/09 & 2/26/09 - All PVOCs reported below laboratory detection limits
 - 3/21/11 - All PVOCs reported below laboratory detection limits
 - 8/4/11 - All PVOCs reported below laboratory detection limits, except toluene (0.47 "J" µg/L). Toluene was not detected at this low level in any samples.
 - 11/4/11 - All PVOCs reported below laboratory detection limits
 - 6/7/12 - All PVOCs reported below laboratory detection limits

Table 3
Groundwater Quality Results
Jacobus Bulk Plant / Retail Station (Former) - 111 E. Decorah Road, West Bend, Wisconsin
Project Reference #6662

Sample Location:		MW-7																NR 140	NR 140		
Sample Date:		12/17/91	9/29/93	1/20/94	3/24/94	6/9/94	9/14/94	12/29/94	8/29/95	12/19/01	3/17/03	12/30/03	4/13/06	9/25/09	3/21/11	8/4/11	11/4/11	6/7/12	ES	PAL	
PVOCs		Units																			
Benzene	µg/l	ND	(3.1)	ND	ND	ND	ND	ND	ND	<0.13	<0.500	<0.500	NA	NA	<0.25	NA	0.39 "J"	<0.5	5	0.5	
Ethylbenzene	µg/l	ND	2.6	ND	ND	ND	ND	ND	ND	<0.22	<0.500	<5.00	NA	NA	<0.22	NA	2.2	<0.78	700	140	
Methyl tert Butyl Ether	µg/l	ND	ND	ND	ND	ND	ND	ND	ND	<0.16	<0.200	<0.146	NA	NA	<0.23	NA	<0.23	<0.8	60	12	
Toluene	µg/l	3	10	ND	ND	ND	ND	ND	ND	<0.20	<0.500	<5.00	NA	NA	<0.25	NA	<0.25	<0.53	800	160	
1,2,4-Trimethylbenzene	µg/l	ND	2.9	ND	ND	ND	1.1	ND	ND	<0.22	<1.00	<5.00	NA	NA	0.33 "J"	NA	3.6	<0.8	NS	NS	
1,3,5-Trimethylbenzene	µg/l	ND	ND	ND	ND	ND	ND	ND	ND	<0.29	<1.00	<5.00	NA	NA	<0.19	NA	0.30 "J"	<0.74	NS	NS	
Total Trimethylbenzene	µg/l	ND	2.9	ND	ND	ND	1.1	ND	ND	<0.51	<2.00	<10.00	NA	NA	0.33 "J"	NA	3.9	<1.54	480	96	
Total Xylenes	µg/l	ND	13	ND	ND	ND	ND	ND	ND	<0.23	<0.500	<5.00	NA	NA	<0.39	NA	12	<1.9	2,000	400	
Detected VOCs																					
n-Butylbenzene	µg/l	NA	NA	NA	NA	NA	NA	NA	NA	NA	NA	NA	NA	NA	NA	NA	NA	NA	NA	NS	NS
Chloroform	µg/l	NA	NA	NA	NA	NA	NA	NA	NA	NA	NA	NA	NA	NA	NA	NA	NA	NA	NA	6	0.6
Chloromethane	µg/l	NA	NA	NA	NA	NA	NA	NA	NA	NA	NA	NA	NA	NA	NA	NA	NA	NA	NA	30	3
Isopropylbenzene	µg/l	NA	NA	NA	NA	NA	NA	NA	NA	NA	NA	NA	NA	NA	NA	NA	NA	NA	NA	NS	NS
Methylene Chloride	µg/l	NA	NA	NA	NA	NA	NA	NA	NA	NA	NA	NA	NA	NA	NA	NA	NA	NA	NA	5	0.5
n-Propylbenzene	µg/l	NA	NA	NA	NA	NA	NA	NA	NA	NA	NA	NA	NA	NA	NA	NA	NA	NA	NA	NS	NS
Naphthalene	µg/l	NA	NA	5	NA	NA	NA	NA	NA	NA	NA	<8.00	NA	NA	<0.50	NA	1.3 "J"	<2.1	100	10	
Dissolved Metals																					
Lead	µg/l	NA	NA	NA	NA	NA	NA	NA	NA	NA	NA	NA	NA	NA	NA	NA	NA	NA	NA	15	1.5

Notes:

- µg/l = micrograms per liter (equivalent to parts per billion, ppb)
- NR 140 ES = Wisconsin Administrative Code, Chapter NR 140 Enforcement Standard
- NR 140 PAL = Wisconsin Administrative Code, Chapter NR 140 Preventive Action Limit
- FP = Free Product in well - no sample collected
- Laboratory flags:
 - "L" = Concentration flagged by laboratory as common lab solvent and contaminant
 - "J" = Concentration reported between Method Detection Limit and Limit of Quantitation
 - "Q" = Unquantitated hydrocarbons present in the sample outside of the reported carbon range (lab indicated these are late end petroleum hydrocarbon peaks)
- Exceedances:
 - [] = Concentration exceeds NR 140 ES
 - () = Concentration exceeds NR 140 PAL
- Trip blank results:
 - 12/19/01 - All PVOCs reported below laboratory detection limits
 - 3/17/03 - All PVOCs reported below laboratory detection limits
 - 12/30/03 - All PVOCs reported below laboratory detection limits
 - 4/13/06 - All PVOCs reported below laboratory detection limits
 - 2/25/09 & 2/26/09 - All PVOCs reported below laboratory detection limits
 - 3/21/11 - All PVOCs reported below laboratory detection limits
 - 8/4/11 - All PVOCs reported below laboratory detection limits
 - 11/4/11 - All PVOCs reported below laboratory detection limits
 - 6/7/12 - All PVOCs reported below laboratory detection limits
- Equipment blank results:
 - 12/19/01 - All PVOCs reported below laboratory detection limits, except for toluene reported at 0.22 µg/l in 1 blank (2 equipment blanks used this event)
 - 3/17/03 - All PVOCs reported below laboratory detection limits
 - 12/30/03 - Not used, as new disposable bailers used at each well to collect groundwater samples
 - 4/13/06 - All PVOCs reported below laboratory detection limits, except benzene (1.3 µg/L) and toluene (0.62 µg/L). Benzene was not detected at low levels in any samples, but toluene was detected at low levels in well MW-15.
 - 2/25/09 & 2/26/09 - All PVOCs reported below laboratory detection limits
 - 3/21/11 - All PVOCs reported below laboratory detection limits
 - 8/4/11 - All PVOCs reported below laboratory detection limits, except toluene (0.47 "J" µg/L). Toluene was not detected at this low of level in any samples.
 - 11/4/11 - All PVOCs reported below laboratory detection limits
 - 6/7/12 - All PVOCs reported below laboratory detection limits

Table 3
Groundwater Quality Results
Jacobus Bulk Plant / Retail Station (Former) - 111 E. Decorah Road, West Bend, Wisconsin
Project Reference #6662

Sample Location:		MW-8																				NR 140	NR 140		
Sample Date:		1/20/94	2/21/94	6/9/94	9/14/94	12/8/94	8/29/95	4/10/96	8/8/96	10/24/96	2/5/97	6/18/97	11/10/99	12/19/01	3/17/03	12/30/03	4/13/06	2/25/09	3/21/11	8/4/11	11/4/11	6/7/12	ES	PAL	
PVOCS		Units																							
	Units																								
Benzene	µg/l	ND	ND	ND	ND	ND	ND	ND	ND	ND	ND	ND	ND	<0.13	<0.500	<0.500	<0.20	<0.25	<0.25	NA	<0.25	NA	5	0.5	
Ethylbenzene	µg/l	ND	ND	ND	ND	ND	ND	ND	ND	ND	ND	ND	ND	<0.22	<0.500	<5.00	<0.50	<0.22	<0.22	NA	<0.22	NA	700	140	
Methyl tert Butyl Ether	µg/l	ND	ND	ND	ND	ND	ND	ND	ND	ND	ND	ND	ND	<0.16	<0.200	<0.146	<0.50	<0.23	<0.23	NA	<0.23	NA	60	12	
Toluene	µg/l	ND	ND	ND	ND	ND	ND	ND	ND	ND	ND	ND	ND	0.23	<0.500	<5.00	<0.20	<0.25	<0.25	NA	<0.25	NA	800	160	
1,2,4-Trimethylbenzene	µg/l	ND	ND	ND	ND	ND	ND	ND	1.2	ND	ND	ND	ND	<0.22	<1.00	<5.00	<0.20	<0.25	<0.25	NA	<0.25	NA	NS	NS	
1,3,5-Trimethylbenzene	µg/l	ND	ND	ND	ND	ND	ND	ND	ND	ND	ND	ND	ND	<0.29	<1.00	<5.00	<0.20	<0.19	<0.19	NA	<0.19	NA	NS	NS	
Total Trimethylbenzene	µg/l	ND	ND	ND	ND	ND	ND	1.2	ND	ND	ND	ND	ND	<0.51	<2.00	<10.00	<0.40	<0.44	<0.44	NA	<0.44	NA	480	96	
Total Xylenes	µg/l	ND	ND	ND	ND	ND	ND	1	ND	ND	ND	ND	ND	0.48	<0.500	<5.00	<0.50	<0.39	<0.39	NA	<0.39	NA	2,000	400	
Detected VOCs																									
n-Butylbenzene	µg/l	NA	NA	NA	NA	NA	NA	NA	NA	NA	NA	NA	NA	NA	NA	NA	NA	NA	NA	NA	NA	NA	NS	NS	
Chloroform	µg/l	NA	NA	NA	NA	NA	NA	NA	NA	NA	NA	NA	NA	NA	NA	NA	NA	NA	NA	NA	NA	NA	6	0.6	
Chloromethane	µg/l	NA	NA	NA	NA	NA	NA	NA	NA	NA	NA	NA	NA	NA	NA	NA	NA	NA	NA	NA	NA	NA	30	3	
Isopropylbenzene	µg/l	NA	NA	NA	NA	NA	NA	NA	NA	NA	NA	NA	NA	NA	NA	NA	NA	NA	NA	NA	NA	NA	NS	NS	
Methylene Chloride	µg/l	NA	NA	NA	NA	NA	NA	NA	NA	NA	NA	NA	NA	NA	NA	NA	NA	NA	NA	NA	NA	NA	5	0.5	
n-Propylbenzene	µg/l	NA	NA	NA	NA	NA	NA	NA	NA	NA	NA	NA	NA	NA	NA	NA	NA	NA	NA	NA	NA	NA	NS	NS	
Naphthalene	µg/l	ND	ND	ND	NA	NA	NA	NA	NA	NA	NA	NA	NA	NA	NA	<8.00	<0.25	<0.50	<0.50	NA	<0.50		100	10	
Dissolved Metals																									
Lead	µg/l	NA	NA	NA	NA	NA	NA	NA	NA	NA	NA	NA	NA	NA	NA	NA	NA	NA	NA	NA	NA	NA	15	1.5	

Notes:

- µg/l = micrograms per liter (equivalent to parts per billion, ppb)
- NR 140 ES = Wisconsin Administrative Code, Chapter NR 140 Enforcement Standard
- NR 140 PAL = Wisconsin Administrative Code, Chapter NR 140 Preventive Action Limit
- FP = Free Product in well - no sample collected
- Laboratory flags:
 - "L" = Concentration flagged by laboratory as common lab solvent and contaminant
 - "J" = Concentration reported between Method Detection Limit and Limit of Quantitation
 - "Q" = Unquantitated hydrocarbons present in the sample outside of the reported carbon range (lab indicated these are late end petroleum hydrocarbon peaks)
- Exceedances:
 - [] = Concentration exceeds NR 140 ES
 - () = Concentration exceeds NR 140 PAL
- Trip blank results:
 - 12/19/01 - All PVOCS reported below laboratory detection limits
 - 3/17/03 - All PVOCS reported below laboratory detection limits
 - 12/30/03 - All PVOCS reported below laboratory detection limits
 - 4/13/06 - All PVOCS reported below laboratory detection limits
 - 2/25/09 & 2/26/09 - All PVOCS reported below laboratory detection limits
 - 3/21/11 - All PVOCS reported below laboratory detection limits
 - 8/4/11 - All PVOCS reported below laboratory detection limits
 - 11/4/11 - All PVOCS reported below laboratory detection limits
 - 6/7/12 - All PVOCS reported below laboratory detection limits
- Equipment blank results:
 - 12/19/01 - All PVOCS reported below laboratory detection limits, except for toluene reported at 0.22 µg/l in 1 blank (2 equipment blanks used this event)
 - 3/17/03 - All PVOCS reported below laboratory detection limits
 - 12/30/03 - Not used, as new disposable bailers used at each well to collect groundwater samples
 - 4/13/06 - All PVOCS reported below laboratory detection limits, except benzene (1.3 µg/L) and toluene (0.62 µg/L). Benzene was not detected at low levels in any samples, but toluene was detected at low levels in well MW-15.
 - 2/25/09 & 2/26/09 - All PVOCS reported below laboratory detection limits
 - 3/21/11 - All PVOCS reported below laboratory detection limits
 - 8/4/11 - All PVOCS reported below laboratory detection limits, except toluene (0.47 "J" µg/L). Toluene was not detected at this low level in any samples.
 - 11/4/11 - All PVOCS reported below laboratory detection limits
 - 6/7/12 - All PVOCS reported below laboratory detection limits

Table 3
Groundwater Quality Results
Jacobus Bulk Plant / Retail Station (Former) - 111 E. Decorah Road, West Bend, Wisconsin
Project Reference #6662

Sample Location:		MW-9																						NR 140	NR 140	
Sample Date:		1/20/94	2/21/94	6/9/94	9/14/94	12/8/94	8/29/95	4/10/96	8/8/96	10/24/96	2/5/97	6/18/97	11/19/98	5/20/99	11/10/99	12/19/01	3/17/03	12/30/03	4/13/06	2/25/09	3/21/11	8/4/11	11/4/11	6/7/12	ES	PAL
PVOCs		Units																								
Benzene	µg/l	[21]	[19]	[5]	(1.5)	(2.4)	0.3	ND	ND	(0.9)	(1.5)	0.2	ND	ND	ND	<0.13	<0.500	<0.500	<0.20	NA	<0.25	NA	<0.25	NA	5	0.5
Ethylbenzene	µg/l	ND	ND	ND	ND	ND	ND	ND	ND	ND	ND	ND	ND	ND	ND	<0.22	<0.500	<5.00	<0.50	NA	<0.22	NA	<0.22	NA	700	140
Methyl tert Butyl Ether	µg/l	ND	11	ND	ND	1.3	ND	ND	ND	ND	0.8	ND	0.8	0.3	1.0	<0.16	<0.200	<0.146	<0.50	NA	<0.23	NA	<0.23	NA	60	12
Toluene	µg/l	ND	1	ND	0.64	ND	ND	ND	0.6	0.2	ND	ND	ND	ND	ND	<0.20	<0.500	<5.00	<0.20	NA	<0.25	NA	<0.25	NA	800	160
1,2,4-Trimethylbenzene	µg/l	ND	ND	ND	ND	ND	ND	0.4	ND	ND	ND	ND	ND	ND	ND	<0.22	<1.00	<5.00	<0.20	NA	<0.25	NA	<0.25	NA	NS	NS
1,3,5-Trimethylbenzene	µg/l	ND	ND	ND	ND	ND	ND	ND	ND	ND	ND	ND	ND	ND	ND	<0.29	<1.00	<5.00	<0.20	NA	<0.19	NA	<0.19	NA	NS	NS
Total Trimethylbenzene	µg/l	ND	ND	ND	ND	ND	ND	0.4	ND	ND	ND	ND	ND	ND	ND	<0.51	<2.00	<10.00	<0.40	NA	<0.44	NA	<0.44	NA	480	96
Total Xylenes	µg/l	ND	ND	ND	ND	ND	ND	0.3	ND	ND	ND	ND	ND	ND	ND	0.27	<0.500	<5.00	<0.50	NA	<0.39	NA	<0.39	NA	2,000	400
Detected VOCs																										
n-Butylbenzene	µg/l	NA	NA	NA	NA	NA	NA	NA	NA	NA	NA	NA	NA	NA	NA	NA	NA	NA	NA	NA	NA	NA	NA	NA	NS	NS
Chloroform	µg/l	NA	NA	NA	NA	NA	NA	NA	NA	NA	NA	NA	NA	NA	NA	NA	NA	NA	NA	NA	NA	NA	NA	NA	6	0.6
Chloromethane	µg/l	NA	NA	NA	NA	NA	NA	NA	NA	NA	NA	NA	NA	NA	NA	NA	NA	NA	NA	NA	NA	NA	NA	NA	30	3
Isopropylbenzene	µg/l	NA	NA	NA	NA	NA	NA	NA	NA	NA	NA	NA	NA	NA	NA	NA	NA	NA	NA	NA	NA	NA	NA	NA	NS	NS
Methylene Chloride	µg/l	NA	NA	NA	NA	NA	NA	NA	NA	NA	NA	NA	NA	NA	NA	NA	NA	NA	NA	NA	NA	NA	NA	NA	5	0.5
n-Propylbenzene	µg/l	NA	NA	NA	NA	NA	NA	NA	NA	NA	NA	NA	NA	NA	NA	NA	NA	NA	NA	NA	NA	NA	NA	NA	NS	NS
Naphthalene	µg/l	NA	NA	NA	NA	NA	NA	NA	NA	NA	NA	NA	NA	NA	NA	NA	NA	<8.00	<0.25	NA	<0.50	NA	<0.50	NA	100	10
Dissolved Metals																										
Lead	µg/l	ND	ND	NA	NA	NA	NA	NA	NA	NA	NA	NA	NA	NA	NA	NA	NA	NA	NA	NA	NA	NA	NA	NA	15	1.5

Notes:

- µg/l = micrograms per liter (equivalent to parts per billion, ppb)
- NR 140 ES = Wisconsin Administrative Code, Chapter NR 140 Enforcement Standard
- NR 140 PAL = Wisconsin Administrative Code, Chapter NR 140 Preventive Action Limit
- FP = Free Product in well - no sample collected
- Laboratory flags:
 - "L" = Concentration flagged by laboratory as common lab solvent and contaminant
 - "J" = Concentration reported between Method Detection Limit and Limit of Quantitation
 - "Q" = Unquantitated hydrocarbons present in the sample outside of the reported carbon range (lab indicated these are late end petroleum hydrocarbon peaks)
- Exceedances:
 - [] = Concentration exceeds NR 140 ES
 - () = Concentration exceeds NR 140 PAL
- Trip blank results:
 - 12/19/01 - All PVOCs reported below laboratory detection limits
 - 3/17/03 - All PVOCs reported below laboratory detection limits
 - 12/30/03 - All PVOCs reported below laboratory detection limits
 - 4/13/06 - All PVOCs reported below laboratory detection limits
 - 2/25/09 & 2/26/09 - All PVOCs reported below laboratory detection limits
 - 3/21/11 - All PVOCs reported below laboratory detection limits
 - 8/4/11 - All PVOCs reported below laboratory detection limits
 - 11/4/11 - All PVOCs reported below laboratory detection limits
 - 6/7/12 - All PVOCs reported below laboratory detection limits
- Equipment blank results:
 - 12/19/01 - All PVOCs reported below laboratory detection limits, except for toluene reported at 0.22 µg/l in 1 blank (2 equipment blanks used this event)
 - 3/17/03 - All PVOCs reported below laboratory detection limits
 - 12/30/03 - Not used, as new disposable bailers used at each well to collect groundwater samples
 - 4/13/06 - All PVOCs reported below laboratory detection limits, except benzene (1.3 µg/L) and toluene (0.62 µg/L). Benzene was not detected at low levels in any samples, but toluene was detected at low levels in well MW-15.
 - 2/25/09 & 2/26/09 - All PVOCs reported below laboratory detection limits
 - 3/21/11 - All PVOCs reported below laboratory detection limits
 - 8/4/11 - All PVOCs reported below laboratory detection limits, except toluene (0.47 "J" µg/L). Toluene was not detected at this low of level in any samples.
 - 11/4/11 - All PVOCs reported below laboratory detection limits
 - 6/7/12 - All PVOCs reported below laboratory detection limits

Table 3
Groundwater Quality Results
Jacobus Bulk Plant / Retail Station (Former) - 111 E. Decorah Road, West Bend, Wisconsin
Project Reference #6662

Sample Location:		MW-10																NR 140	NR 140
Sample Date:		1/20/94	2/21/94	6/9/94	9/14/94	12/8/94	6/18/97	12/19/01	3/17/03	12/30/03	4/13/06	2/25/09	3/21/11	8/4/11	11/4/11	6/7/12	6/12 Dup	ES	PAL
PVOCs																			
	Units																		
Benzene	µg/l	[24,000]	[13,000]	[16,000]	[18,000]	[33,000]	[7,000]	[1,700]	FP	NA	[400]	[780]	NA	[21]	[180]	[33]	36	5	0.5
Ethylbenzene	µg/l	[2,700]	[6,700]	[3,300]	[3,000]	[2,900]	[1,400]	[2,000]	FP	NA	[1,900]	[2,200]	NA	(430)	(650)	(207)	214	700	140
Methyl tert Butyl Ether	µg/l	[1,300]	<500	[3,400]	ND	ND	[150]	<16	FP	NA	<100	<9.2	NA	<2.3	<1.2	<8	<8	60	12
Toluene	µg/l	[39,000]	[57,000]	[34,000]	[30,000]	[74,000]	[10,000]	[5,500]	FP	NA	150	(210)	NA	15 "J"	56	17.2	13.2 "J"	800	160
1,2,4-Trimethylbenzene	µg/l	<1,000	4,300	1,800	2,700	1,100	800	3,000	FP	NA	11,000	1,300	NA	650	660	340	360	NS	NS
1,3,5-Trimethylbenzene	µg/l	<1,000	560	<1,000	<1,000	290	200	840	FP	NA	4,100	330	NA	27	51	<7.4	<7.4	NS	NS
Total Trimethylbenzene	µg/l	<2,000	[4,860]	[1,800]	[2,700]	[1,390]	[1,000]	[3,840]	FP	NA	[15,100]	[1,630]	NA	[677]	[711]	(340)	360	480	96
Total Xylenes	µg/l	[16,000]	[45,000]	[19,000]	[15,200]	[18,600]	[8,300]	[15,000]	FP	NA	[20,000]	[9,200]	NA	(1,600)	[3,000]	(786)	775	2,000	400
Detected VOCs																			
n-Butylbenzene	µg/l	NA	NA	NA	NA	NA	NA	NA	NA	NA	NA	NA	NA	NA	NA	NA	NA	NS	NS
Chloroform	µg/l	NA	NA	NA	NA	NA	NA	NA	NA	NA	NA	NA	NA	NA	NA	NA	NA	6	0.6
Chloromethane	µg/l	NA	NA	NA	NA	NA	NA	NA	NA	NA	NA	NA	NA	NA	NA	NA	NA	30	3
Isopropylbenzene	µg/l	NA	NA	NA	NA	NA	NA	NA	NA	NA	NA	NA	NA	NA	NA	NA	NA	NS	NS
Methylene Chloride	µg/l	NA	NA	NA	NA	NA	NA	NA	NA	NA	NA	NA	NA	NA	NA	NA	NA	5	0.5
n-Propylbenzene	µg/l	NA	NA	NA	NA	NA	NA	NA	NA	NA	NA	NA	NA	NA	NA	NA	NA	NS	NS
Naphthalene	µg/l	<1,000	[4,400]	NA	NA	NA	NA	NA	NA	NA	[1,500]	[260]	NA	[160]	[140]	(67 "J")	69	100	10
Dissolved Metals																			
Lead	µg/l	NA	NA	NA	NA	NA	NA	NA	NA	NA	NA	NA	NA	NA	NA	NA	NA	15	1.5

Notes:

- µg/l = micrograms per liter (equivalent to parts per billion, ppb)
- NR 140 ES = Wisconsin Administrative Code, Chapter NR 140 Enforcement Standard
- NR 140 PAL = Wisconsin Administrative Code, Chapter NR 140 Preventive Action Limit
- FP = Free Product in well - no sample collected
- Laboratory flags:
 - "L" = Concentration flagged by laboratory as common lab solvent and contaminant
 - "J" = Concentration reported between Method Detection Limit and Limit of Quantitation
 - "Q" = Unquantitated hydrocarbons present in the sample outside of the reported carbon range (lab indicated these are late end petroleum hydrocarbon peaks)
- Exceedances:
 - [] = Concentration exceeds NR 140 ES
 - () = Concentration exceeds NR 140 PAL
- Trip blank results:
 - 12/19/01 - All PVOCs reported below laboratory detection limits
 - 3/17/03 - All PVOCs reported below laboratory detection limits
 - 12/30/03 - All PVOCs reported below laboratory detection limits
 - 4/13/06 - All PVOCs reported below laboratory detection limits
 - 2/25/09 & 2/26/09 - All PVOCs reported below laboratory detection limits
 - 3/21/11 - All PVOCs reported below laboratory detection limits
 - 8/4/11 - All PVOCs reported below laboratory detection limits
 - 11/4/11 - All PVOCs reported below laboratory detection limits
 - 6/7/12 - All PVOCs reported below laboratory detection limits
- Equipment blank results:
 - 12/19/01 - All PVOCs reported below laboratory detection limits, except for toluene reported at 0.22 µg/l in 1 blank (2 equipment blanks used this event)
 - 3/17/03 - All PVOCs reported below laboratory detection limits
 - 12/30/03 - Not used, as new disposable bailers used at each well to collect groundwater samples
 - 4/13/06 - All PVOCs reported below laboratory detection limits, except benzene (1.3 µg/L) and toluene (0.62 µg/L). Benzene was not detected at low levels in any samples, but toluene was detected at low levels in well MW-15.
 - 2/25/09 & 2/26/09 - All PVOCs reported below laboratory detection limits
 - 3/21/11 - All PVOCs reported below laboratory detection limits
 - 8/4/11 - All PVOCs reported below laboratory detection limits, except toluene (0.47 "J" µg/L). Toluene was not detected at this low of level in any samples.
 - 11/4/11 - All PVOCs reported below laboratory detection limits
 - 6/7/12 - All PVOCs reported below laboratory detection limits

Table 3
Groundwater Quality Results
Jacobus Bulk Plant / Retail Station (Former) - 111 E. Decorah Road, West Bend, Wisconsin
Project Reference #6662

Sample Location:		MW-11																	NR 140	NR 140
Sample Date:		1/20/94	2/21/94	10/24/96	6/18/97	11/20/98	5/20/99	11/10/99	12/19/01	12/01 Dup 1	3/17/03	12/30/03	4/13/06	2/25/09	3/21/11	8/4/11	11/4/11	6/7/12	ES	PAL
PVOCs		Units																		
Benzene	µg/l	[1,000]	[40,000]	[6,910]	[9,400]	[3,600]	[7,800]	[1,700]	[7,000]	5,700	FP	FP	[4,200]	[580]	[510]	[1,000]	[640]	[1,050]	5	0.5
Ethylbenzene	µg/l	[2,600]	[54,000]	[3,870]	[2,400]	[2,100]	[2,400]	[2,100]	[2,200]	1,900	FP	FP	[2,600]	[1,800]	[1,400]	[2,200]	[2,100]	[2,100]	700	140
Methyl tert Butyl Ether	µg/l	<1,000	<5,000	<200	[80]	<20	<40	<20	<16	<6.4	FP	FP	<100	<9.2	<9.2	<5.8	<4.6	<40	60	12
Toluene	µg/l	[31,000]	[150,000]	[25,700]	[18,000]	[910]	[3,400]	[3,100]	[340]	320	FP	FP	[410]	61	38 "J"	[180]	[210]	[221]	800	160
1,2,4-Trimethylbenzene	µg/l	<1,000	280,000	12,600	1,400	1,600	2,800	2,000	1,900	1,800	FP	FP	2,500	2,700	1,800	2,000	2,200	2,260	NS	NS
1,3,5-Trimethylbenzene	µg/l	<1,000	26,000	3,290	700	1,300	820	580	520	450	FP	FP	660	790	790	750	820	860	NS	NS
Total Trimethylbenzene	µg/l	<2,000	[306,000]	[15,890]	[2,100]	[2,900]	[3,620]	[2,580]	[2,420]	2,250	FP	FP	[3,160]	[3,490]	[2,590]	[2,750]	[3,020]	[3,120]	480	96
Total Xylenes	µg/l	[15,600]	[460,000]	[29,450]	[14,800]	[14,300]	[17,600]	[13,300]	[16,000]	14,000	FP	FP	[18,000]	[11,000]	[6,900]	[9,100]	[8,400]	[8,794]	2,000	400
Detected VOCs																				
n-Butylbenzene	µg/l	NA	NA	NA	NA	NA	NA	NA	NA	NA	NA	NA	NA	NA	NA	NA	NA	NA	NS	NS
Chloroform	µg/l	NA	NA	NA	NA	NA	NA	NA	NA	NA	NA	NA	NA	NA	NA	NA	NA	NA	6	0.6
Chloromethane	µg/l	NA	NA	NA	NA	NA	NA	NA	NA	NA	NA	NA	NA	NA	NA	NA	NA	NA	30	3
Isopropylbenzene	µg/l	NA	NA	NA	NA	NA	NA	NA	NA	NA	NA	NA	NA	NA	NA	NA	NA	NA	NS	NS
Methylene Chloride	µg/l	NA	NA	NA	NA	NA	NA	NA	NA	NA	NA	NA	NA	NA	NA	NA	NA	NA	5	0.5
n-Propylbenzene	µg/l	NA	NA	NA	NA	NA	NA	NA	NA	NA	NA	NA	NA	NA	NA	NA	NA	NA	NS	NS
Naphthalene	µg/l	<1,000	[88,000]	NA	NA	NA	NA	NA	NA	NA	FP	[670]	[520]	[330]	[440]	[450]	[540]		100	10
Dissolved Metals																				
Lead	µg/l	NA	NA	NA	NA	NA	NA	NA	NA	NA	NA	NA	NA	NA	NA	NA	NA	NA	15	1.5

Notes:

- µg/l = micrograms per liter (equivalent to parts per billion, ppb)
- NR 140 ES = Wisconsin Administrative Code, Chapter NR 140 Enforcement Standard
- NR 140 PAL = Wisconsin Administrative Code, Chapter NR 140 Preventive Action Limit
- FP = Free Product in well - no sample collected
- Laboratory flags:
 - "L" = Concentration flagged by laboratory as common lab solvent and contaminant
 - "J" = Concentration reported between Method Detection Limit and Limit of Quantitation
 - "Q" = Unquantitated hydrocarbons present in the sample outside of the reported carbon range (lab indicated these are late end petroleum hydrocarbon peaks)
- Exceedances:
 - [] = Concentration exceeds NR 140 ES
 - () = Concentration exceeds NR 140 PAL
- Trip blank results:
 - 12/19/01 - All PVOCs reported below laboratory detection limits
 - 3/17/03 - All PVOCs reported below laboratory detection limits
 - 12/30/03 - All PVOCs reported below laboratory detection limits
 - 4/13/06 - All PVOCs reported below laboratory detection limits
 - 2/25/09 & 2/26/09 - All PVOCs reported below laboratory detection limits
 - 3/21/11 - All PVOCs reported below laboratory detection limits
 - 8/4/11 - All PVOCs reported below laboratory detection limits
 - 11/4/11 - All PVOCs reported below laboratory detection limits
 - 6/7/12 - All PVOCs reported below laboratory detection limits
- Equipment blank results:
 - 12/19/01 - All PVOCs reported below laboratory detection limits, except for toluene reported at 0.22 µg/l in 1 blank (2 equipment blanks used this event)
 - 3/17/03 - All PVOCs reported below laboratory detection limits
 - 12/30/03 - Not used, as new disposable bailers used at each well to collect groundwater samples
 - 4/13/06 - All PVOCs reported below laboratory detection limits, except benzene (1.3 µg/L) and toluene (0.62 µg/L). Benzene was not detected at low levels in any samples, but toluene was detected at low levels in well MW-15.
 - 2/25/09 & 2/26/09 - All PVOCs reported below laboratory detection limits
 - 3/21/11 - All PVOCs reported below laboratory detection limits
 - 8/4/11 - All PVOCs reported below laboratory detection limits, except toluene (0.47 "J" µg/L). Toluene was not detected at this low of level in any samples.
 - 11/4/11 - All PVOCs reported below laboratory detection limits
 - 6/7/12 - All PVOCs reported below laboratory detection limits

Table 3
Groundwater Quality Results
Jacobus Bulk Plant / Retail Station (Former) - 111 E. Decorah Road, West Bend, Wisconsin
Project Reference #6662

Sample Location:		MW-12																							NR 140	NR 140	
Sample Date:		1/20/94	2/21/94	6/9/94	9/14/94	12/8/94	8/29/95	4/10/96	8/8/96	10/24/96	6/18/97	11/20/98	5/20/99	11/10/99	12/19/01	3/17/03	3/03 Dup 1	12/30/03	4/13/06	2/25/09	3/21/11	8/4/11	11/4/11	6/7/12	ES	PAL	
PVOCs																											
	Units																										
Benzene	µg/l	ND	(1)	ND	ND	ND	ND	ND	ND	ND	ND	ND	ND	ND	<0.13	<0.500	<0.500	<0.500	<0.20	<0.25	<0.25	NA	<0.25	NA	5	0.5	
Ethylbenzene	µg/l	ND	ND	ND	ND	ND	ND	ND	ND	ND	ND	ND	ND	ND	<0.22	<0.500	<0.500	<5.00	<0.50	<0.22	<0.22	NA	<0.22	NA	700	140	
Methyl tert Butyl Ether	µg/l	ND	ND	ND	ND	ND	ND	ND	ND	ND	ND	(13)	6.7	(16)	6.7	<0.200	1.61	1.05	<0.50	<0.23	<0.23	NA	<0.23	NA	60	12	
Toluene	µg/l	ND	3	ND	ND	1.1	ND	ND	ND	ND	ND	ND	ND	ND	0.39	<0.500	<0.500	<5.00	<0.20	0.28 "J"	<0.25	NA	<0.25	NA	800	160	
1,2,4-Trimethylbenzene	µg/l	ND	ND	ND	ND	ND	ND	ND	ND	ND	ND	ND	ND	ND	2.5	<1.00	<1.00	<5.00	<0.20	<0.25	<0.25	NA	<0.25	NA	NS	NS	
1,3,5-Trimethylbenzene	µg/l	ND	ND	ND	ND	ND	ND	ND	ND	ND	ND	ND	ND	ND	0.91	<1.00	<1.00	<5.00	<0.20	<0.19	<0.19	NA	<0.19	NA	NS	NS	
Total Trimethylbenzene	µg/l	ND	ND	ND	ND	ND	ND	ND	ND	ND	ND	ND	ND	ND	3.41	<2.00	<2.00	<10.00	<0.40	<0.44	<0.44	NA	<0.44	NA	480	96	
Total Xylenes	µg/l	ND	ND	ND	ND	ND	ND	ND	ND	ND	ND	ND	ND	ND	1.8	<0.500	<0.500	<5.00	<0.50	<0.39	<0.39	NA	<0.39	NA	2,000	400	
Detected VOCs																											
n-Butylbenzene	µg/l	NA	NA	NA	NA	NA	NA	NA	NA	NA	NA	NA	NA	NA	NA	NA	NA	NA	NA	NA	NA	NA	NA	NA	NA	NS	NS
Chloroform	µg/l	NA	NA	NA	NA	NA	NA	NA	NA	NA	NA	NA	NA	NA	NA	NA	NA	NA	NA	NA	NA	NA	NA	NA	NA	6	0.6
Chloromethane	µg/l	NA	NA	NA	NA	NA	NA	NA	NA	NA	NA	NA	NA	NA	NA	NA	NA	NA	NA	NA	NA	NA	NA	NA	NA	30	3
Isopropylbenzene	µg/l	NA	NA	NA	NA	NA	NA	NA	NA	NA	NA	NA	NA	NA	NA	NA	NA	NA	NA	NA	NA	NA	NA	NA	NA	NS	NS
Methylene Chloride	µg/l	NA	NA	NA	NA	NA	NA	NA	NA	NA	NA	NA	NA	NA	NA	NA	NA	NA	NA	NA	NA	NA	NA	NA	NA	5	0.5
n-Propylbenzene	µg/l	NA	NA	NA	NA	NA	NA	NA	NA	NA	NA	NA	NA	NA	NA	NA	NA	NA	NA	NA	NA	NA	NA	NA	NA	NS	NS
Naphthalene	µg/l	2	5	NA	NA	NA	NA	NA	NA	NA	NA	NA	NA	NA	NA	NA	NA	NA	<8.00	<0.25	<0.50	<0.50	NA	<0.50	NA	100	10
Dissolved Metals																											
Lead	µg/l	NA	NA	NA	NA	NA	NA	NA	NA	NA	NA	NA	NA	NA	NA	NA	NA	NA	NA	NA	NA	NA	NA	NA	NA	15	1.5

Notes:

- µg/l = micrograms per liter (equivalent to parts per billion, ppb)
- NR 140 ES = Wisconsin Administrative Code, Chapter NR 140 Enforcement Standard
- NR 140 PAL = Wisconsin Administrative Code, Chapter NR 140 Preventive Action Limit
- FP = Free Product in well - no sample collected
- Laboratory flags:
 - "L" = Concentration flagged by laboratory as common lab solvent and contaminant
 - "J" = Concentration reported between Method Detection Limit and Limit of Quantitation
 - "Q" = Unquantitated hydrocarbons present in the sample outside of the reported carbon range (lab indicated these are late end petroleum hydrocarbon peaks)
- Exceedances:
 - [] = Concentration exceeds NR 140 ES
 - () = Concentration exceeds NR 140 PAL
- Trip blank results:
 - 12/19/01 - All PVOCs reported below laboratory detection limits
 - 3/17/03 - All PVOCs reported below laboratory detection limits
 - 12/30/03 - All PVOCs reported below laboratory detection limits
 - 4/13/06 - All PVOCs reported below laboratory detection limits
 - 2/25/09 & 2/26/09 - All PVOCs reported below laboratory detection limits
 - 3/21/11 - All PVOCs reported below laboratory detection limits
 - 8/4/11 - All PVOCs reported below laboratory detection limits
 - 11/4/11 - All PVOCs reported below laboratory detection limits
 - 6/7/12 - All PVOCs reported below laboratory detection limits
- Equipment blank results:
 - 12/19/01 - All PVOCs reported below laboratory detection limits, except for toluene reported at 0.22 µg/l in 1 blank (2 equipment blanks used this event)
 - 3/17/03 - All PVOCs reported below laboratory detection limits
 - 12/30/03 - Not used, as new disposable bailers used at each well to collect groundwater samples
 - 4/13/06 - All PVOCs reported below laboratory detection limits, except benzene (1.3 µg/L) and toluene (0.62 µg/L). Benzene was not detected at low levels in any samples, but toluene was detected at low levels in well MW-15.
 - 2/25/09 & 2/26/09 - All PVOCs reported below laboratory detection limits
 - 3/21/11 - All PVOCs reported below laboratory detection limits
 - 8/4/11 - All PVOCs reported below laboratory detection limits, except toluene (0.47 "J" µg/L). Toluene was not detected at this low of level in any samples.
 - 11/4/11 - All PVOCs reported below laboratory detection limits
 - 6/7/12 - All PVOCs reported below laboratory detection limits

Table 3
Groundwater Quality Results
Jacobus Bulk Plant / Retail Station (Former) - 111 E. Decorah Road, West Bend, Wisconsin
Project Reference #6662

Sample Location:		MW-13																		NR 140	NR 140		
Sample Date:		1/20/94	2/21/94	6/9/94	9/14/94	12/8/94	8/29/95	4/10/96	8/8/96	10/24/96	6/18/97	11/10/99	12/19/01	3/17/03	12/30/03	4/13/06	2/25/09	3/21/11	8/4/11	11/4/11	6/7/12	ES	PAL
PVOCs	Units																						
Benzene	µg/l	ND	ND	ND	ND	ND	ND	ND	ND	ND	ND	ND	<0.13	<0.500	<0.500	<0.20	<0.25	<0.25	NA	<0.25	<0.5	5	0.5
Ethylbenzene	µg/l	ND	ND	ND	ND	ND	ND	ND	ND	ND	0.4	ND	0.55	<0.500	<5.00	<0.50	<0.22	<0.22	NA	<0.22	<0.78	700	140
Methyl tert Butyl Ether	µg/l	ND	1	ND	ND	ND	ND	ND	ND	ND	ND	ND	<0.16	<0.200	<0.146	<0.50	<0.23	<0.23	NA	<0.23	<0.8	60	12
Toluene	µg/l	ND	2	ND	0.93	ND	ND	ND	ND	ND	ND	ND	0.87	<0.500	<5.00	<0.20	<0.25	<0.25	NA	<0.25	<0.53	800	160
1,2,4-Trimethylbenzene	µg/l	ND	ND	ND	ND	ND	ND	ND	ND	ND	1.1	1.2	7.3	<1.00	<5.00	<0.20	2.3	<0.25	NA	0.56 "J"	0.80 "J"	NS	NS
1,3,5-Trimethylbenzene	µg/l	ND	ND	ND	ND	ND	ND	ND	ND	ND	ND	ND	2.1	<1.00	<5.00	<0.20	2.3	<0.19	NA	0.33 "J"	0.76 "J"	NS	NS
Total Trimethylbenzene	µg/l	ND	ND	ND	ND	ND	ND	ND	ND	ND	1.1	1.2	9.4	<2.00	<10.00	<0.40	4.6	<0.44	NA	0.89 "J"	1.56 "J"	480	96
Total Xylenes	µg/l	ND	3	ND	ND	ND	ND	ND	ND	ND	4.2	3.6	8.9	<0.500	<5.00	<0.50	<0.39	<0.39	NA	<0.39	<1.9	2,000	400
Detected VOCs																							
n-Butylbenzene	µg/l	NA	NA	NA	NA	NA	NA	NA	NA	NA	NA	NA	NA	NA	NA	NA	NA	NA	NA	NA	NA	NS	NS
Chloroform	µg/l	NA	NA	NA	NA	NA	NA	NA	NA	NA	NA	NA	NA	NA	NA	NA	NA	NA	NA	NA	NA	6	0.6
Chloromethane	µg/l	NA	NA	NA	NA	NA	NA	NA	NA	NA	NA	NA	NA	NA	NA	NA	NA	NA	NA	NA	NA	30	3
Isopropylbenzene	µg/l	NA	NA	NA	NA	NA	NA	NA	NA	NA	NA	NA	NA	NA	NA	NA	NA	NA	NA	NA	NA	NS	NS
Methylene Chloride	µg/l	NA	NA	NA	NA	NA	NA	NA	NA	NA	NA	NA	NA	NA	NA	NA	NA	NA	NA	NA	NA	5	0.5
n-Propylbenzene	µg/l	NA	NA	NA	NA	NA	NA	NA	NA	NA	NA	NA	NA	NA	NA	NA	NA	NA	NA	NA	NA	NS	NS
Naphthalene	µg/l	(10)	5	NA	NA	NA	NA	NA	NA	NA	NA	NA	NA	NA	<8.00	0.34 "J"	2.6	<0.50	NA	3.1	<2.1	100	10
Dissolved Metals																							
Lead	µg/l	NA	NA	NA	NA	NA	NA	NA	NA	NA	NA	NA	NA	NA	NA	NA	NA	NA	NA	NA	NA	15	1.5

Notes:

- µg/l = micrograms per liter (equivalent to parts per billion, ppb)
- NR 140 ES = Wisconsin Administrative Code, Chapter NR 140 Enforcement Standard
- NR 140 PAL = Wisconsin Administrative Code, Chapter NR 140 Preventive Action Limit
- FP = Free Product in well - no sample collected
- Laboratory flags:
 - "L" = Concentration flagged by laboratory as common lab solvent and contaminant
 - "J" = Concentration reported between Method Detection Limit and Limit of Quantitation
 - "Q" = Unquantitated hydrocarbons present in the sample outside of the reported carbon range (lab indicated these are late end petroleum hydrocarbon peaks)
- Exceedances:
 - [] = Concentration exceeds NR 140 ES
 - () = Concentration exceeds NR 140 PAL
- Trip blank results:
 - 12/19/01 - All PVOCs reported below laboratory detection limits
 - 3/17/03 - All PVOCs reported below laboratory detection limits
 - 12/30/03 - All PVOCs reported below laboratory detection limits
 - 4/13/06 - All PVOCs reported below laboratory detection limits
 - 2/25/09 & 2/26/09 - All PVOCs reported below laboratory detection limits
 - 3/21/11 - All PVOCs reported below laboratory detection limits
 - 8/4/11 - All PVOCs reported below laboratory detection limits
 - 11/4/11 - All PVOCs reported below laboratory detection limits
 - 6/7/12 - All PVOCs reported below laboratory detection limits
- Equipment blank results:
 - 12/19/01 - All PVOCs reported below laboratory detection limits, except for toluene reported at 0.22 µg/l in 1 blank (2 equipment blanks used this event)
 - 3/17/03 - All PVOCs reported below laboratory detection limits
 - 12/30/03 - Not used, as new disposable bailers used at each well to collect groundwater samples
 - 4/13/06 - All PVOCs reported below laboratory detection limits, except benzene (1.3 µg/L) and toluene (0.62 µg/L). Benzene was not detected at low levels in any samples, but toluene was detected at low levels in well MW-15.
 - 2/25/09 & 2/26/09 - All PVOCs reported below laboratory detection limits
 - 3/21/11 - All PVOCs reported below laboratory detection limits
 - 8/4/11 - All PVOCs reported below laboratory detection limits, except toluene (0.47 "J" µg/L). Toluene was not detected at this low of level in any samples.
 - 11/4/11 - All PVOCs reported below laboratory detection limits
 - 6/7/12 - All PVOCs reported below laboratory detection limits

Table 3
Groundwater Quality Results
Jacobus Bulk Plant / Retail Station (Former) - 111 E. Decorah Road, West Bend, Wisconsin
Project Reference #6662

Sample Location:		MW-14																				NR 140	NR 140				
Sample Date:		1/20/94	2/21/94	6/9/94	9/14/94	12/8/94	8/29/95	4/10/96	8/8/96	10/24/96	6/18/97	11/19/98	5/20/99	11/10/99	12/19/01	3/17/03	12/30/03	4/13/06	2/25/09	3/21/11	8/4/11	11/4/11	6/7/12	ES	PAL		
PVOCs		Units																									
Benzene	µg/l	ND	(1)	ND	ND	ND	ND	ND	ND	ND	ND	ND	ND	ND	ND	<0.13	<0.500	<0.500	<0.20	<0.25	<0.25	NA	<0.25	NA	5	0.5	
Ethylbenzene	µg/l	ND	ND	ND	ND	ND	ND	ND	ND	ND	ND	ND	ND	ND	ND	<0.22	<0.500	<5.00	<0.50	<0.22	<0.22	NA	<0.22	NA	700	140	
Methyl tert Butyl Ether	µg/l	ND	1	ND	ND	ND	ND	ND	ND	ND	ND	ND	ND	ND	ND	<0.16	<0.200	<0.146	<0.50	<0.23	<0.23	NA	<0.23	NA	60	12	
Toluene	µg/l	ND	2	ND	ND	ND	0.3	ND	ND	0.2	ND	ND	ND	ND	ND	<0.20	<0.500	<5.00	<0.20	<0.25	<0.25	NA	<0.25	NA	800	160	
1,2,4-Trimethylbenzene	µg/l	ND	ND	ND	ND	ND	ND	ND	ND	ND	ND	ND	ND	ND	ND	<0.22	<1.00	<5.00	<0.20	<0.25	<0.25	NA	<0.25	NA	NS	NS	
1,3,5-Trimethylbenzene	µg/l	ND	ND	ND	ND	ND	ND	ND	ND	ND	ND	ND	ND	ND	ND	<0.29	<1.00	<5.00	<0.20	<0.19	<0.19	NA	<0.19	NA	NS	NS	
Total Trimethylbenzene	µg/l	ND	ND	ND	ND	ND	ND	ND	ND	ND	ND	ND	ND	ND	ND	<0.51	<2.00	<10.00	<0.40	<0.44	<0.44	NA	<0.44	NA	480	96	
Total Xylenes	µg/l	ND	ND	ND	ND	ND	ND	ND	ND	ND	ND	ND	ND	ND	ND	<0.23	<0.500	<5.00	<0.50	<0.39	<0.39	NA	<0.39	NA	2,000	400	
Detected VOCs																											
n-Butylbenzene	µg/l	NA	NA	NA	NA	NA	NA	NA	NA	NA	NA	NA	NA	NA	NA	NA	NA	NA	NA	NA	NA	NA	NA	NA	NS	NS	
Chloroform	µg/l	NA	NA	NA	NA	NA	NA	NA	NA	NA	NA	NA	NA	NA	NA	NA	NA	NA	NA	NA	NA	NA	NA	NA	6	0.6	
Chloromethane	µg/l	NA	NA	NA	NA	NA	NA	NA	NA	NA	NA	NA	NA	NA	NA	NA	NA	NA	NA	NA	NA	NA	NA	NA	30	3	
Isopropylbenzene	µg/l	NA	NA	NA	NA	NA	NA	NA	NA	NA	NA	NA	NA	NA	NA	NA	NA	NA	NA	NA	NA	NA	NA	NA	NS	NS	
Methylene Chloride	µg/l	NA	NA	NA	NA	NA	NA	NA	NA	NA	NA	NA	NA	NA	NA	NA	NA	NA	NA	NA	NA	NA	NA	NA	5	0.5	
n-Propylbenzene	µg/l	NA	NA	NA	NA	NA	NA	NA	NA	NA	NA	NA	NA	NA	NA	NA	NA	NA	NA	NA	NA	NA	NA	NA	NS	NS	
Naphthalene	µg/l	3	3	NA	NA	NA	NA	NA	NA	NA	NA	NA	NA	NA	NA	NA	NA	<8.00	<0.25	<0.50	<0.50	NA	<0.50	NA	100	10	
Dissolved Metals																											
Lead	µg/l	NA	NA	NA	NA	NA	NA	NA	NA	NA	NA	NA	NA	NA	NA	NA	NA	NA	NA	NA	NA	NA	NA	NA	NA	15	1.5

Notes:

- µg/l = micrograms per liter (equivalent to parts per billion, ppb)
- NR 140 ES = Wisconsin Administrative Code, Chapter NR 140 Enforcement Standard
- NR 140 PAL = Wisconsin Administrative Code, Chapter NR 140 Preventive Action Limit
- FP = Free Product in well - no sample collected
- Laboratory flags:
 - "L" = Concentration flagged by laboratory as common lab solvent and contaminant
 - "J" = Concentration reported between Method Detection Limit and Limit of Quantitation
 - "Q" = Unquantitated hydrocarbons present in the sample outside of the reported carbon range (lab indicated these are late end petroleum hydrocarbon peaks)
- Exceedances:
 - [] = Concentration exceeds NR 140 ES
 - () = Concentration exceeds NR 140 PAL
- Trip blank results:
 - 12/19/01 - All PVOCs reported below laboratory detection limits
 - 3/17/03 - All PVOCs reported below laboratory detection limits
 - 12/30/03 - All PVOCs reported below laboratory detection limits
 - 4/13/06 - All PVOCs reported below laboratory detection limits
 - 2/25/09 & 2/26/09 - All PVOCs reported below laboratory detection limits
 - 3/21/11 - All PVOCs reported below laboratory detection limits
 - 8/4/11 - All PVOCs reported below laboratory detection limits
 - 11/4/11 - All PVOCs reported below laboratory detection limits
 - 6/7/12 - All PVOCs reported below laboratory detection limits
- Equipment blank results:
 - 12/19/01 - All PVOCs reported below laboratory detection limits, except for toluene reported at 0.22 µg/l in 1 blank (2 equipment blanks used this event)
 - 3/17/03 - All PVOCs reported below laboratory detection limits
 - 12/30/03 - Not used, as new disposable bailers used at each well to collect groundwater samples
 - 4/13/06 - All PVOCs reported below laboratory detection limits, except benzene (1.3 µg/L) and toluene (0.62 µg/L). Benzene was not detected at low levels in any samples, but toluene was detected at low levels in well MW-15.
 - 2/25/09 & 2/26/09 - All PVOCs reported below laboratory detection limits
 - 3/21/11 - All PVOCs reported below laboratory detection limits
 - 8/4/11 - All PVOCs reported below laboratory detection limits, except toluene (0.47 "J" µg/L). Toluene was not detected at this low of level in any samples.
 - 11/4/11 - All PVOCs reported below laboratory detection limits
 - 6/7/12 - All PVOCs reported below laboratory detection limits

Table 3 Groundwater Quality Results Jacobus Bulk Plant / Retail Station (Former) - 111 E. Decorah Road, West Bend, Wisconsin Project Reference #6662																				
Sample Location:		MW-15																NR 140	NR 140	
Sample Date:		1/30/96	3/6/96	8/8/96	2/5/97	6/18/97	11/19/98	5/20/99	11/10/99	12/19/01	3/17/03	12/30/03	4/13/06	2/25/09	3/21/11	8/4/11	11/4/11	6/7/12	ES	PAL
PVOCs		Units																		
		µg/l																		
Benzene	µg/l	ND	ND	ND	ND	ND	ND	ND	ND	<0.13	<0.500	<0.500	<0.20	<0.25	NA	<0.25	<0.25	NA	5	0.5
Ethylbenzene	µg/l	ND	ND	ND	ND	0.2	ND	ND	ND	<0.22	<0.500	<5.00	<0.50	<0.22	NA	<0.22	<0.22	NA	700	140
Methyl tert Butyl Ether	µg/l	0.8	1.2	0.4	1.1	ND	ND	0.3	ND	<0.16	<0.200	0.153	<0.50	<0.23	NA	<0.23	<0.23	NA	60	12
Toluene	µg/l	ND	ND	ND	ND	ND	ND	ND	ND	<0.20	<0.500	<5.00	0.21 "J"	<0.25	NA	<0.25	<0.25	NA	800	160
1,2,4-Trimethylbenzene	µg/l	0.4	ND	ND	ND	ND	ND	ND	ND	<0.22	<1.00	<5.00	<0.20	<0.25	NA	<0.25	<0.25	NA	NS	NS
1,3,5-Trimethylbenzene	µg/l	ND	ND	ND	ND	ND	ND	ND	ND	<0.29	<1.00	<5.00	<0.20	<0.19	NA	<0.19	<0.19	NA	NS	NS
Total Trimethylbenzene	µg/l	0.4	ND	ND	ND	ND	ND	ND	ND	<0.51	<2.00	<10.00	<0.40	<0.44	NA	<0.44	<0.44	NA	480	96
Total Xylenes	µg/l	ND	ND	ND	ND	ND	ND	ND	0.9 "J"	<0.23	<0.500	<5.00	<0.50	<0.39	NA	<0.39	<0.39	NA	2,000	400
Detected VOCs																				
n-Butylbenzene	µg/l	NA	NA	NA	NA	NA	NA	NA	NA	NA	NA	NA	NA	NA	NA	NA	NA	NA	NS	NS
Chloroform	µg/l	NA	NA	NA	NA	NA	NA	NA	NA	NA	NA	NA	NA	NA	NA	NA	NA	NA	6	0.6
Chloromethane	µg/l	NA	NA	NA	NA	NA	NA	NA	NA	NA	NA	NA	NA	NA	NA	NA	NA	NA	30	3
Isopropylbenzene	µg/l	NA	NA	NA	NA	NA	NA	NA	NA	NA	NA	NA	NA	NA	NA	NA	NA	NA	NS	NS
Methylene Chloride	µg/l	NA	NA	NA	NA	NA	NA	NA	NA	NA	NA	NA	NA	NA	NA	NA	NA	NA	5	0.5
n-Propylbenzene	µg/l	NA	NA	NA	NA	NA	NA	NA	NA	NA	NA	NA	NA	NA	NA	NA	NA	NA	NS	NS
Naphthalene	µg/l	NA	NA	NA	NA	NA	NA	NA	NA	NA	NA	<8.00	<0.25	<0.50	NA	<0.50	<0.50	NA	100	10
Dissolved Metals																				
Lead	µg/l	NA	NA	NA	NA	NA	NA	NA	NA	NA	NA	NA	NA	NA	NA	NA	NA	NA	15	1.5

Notes:

- µg/l = micrograms per liter (equivalent to parts per billion, ppb)
- NR 140 ES = Wisconsin Administrative Code, Chapter NR 140 Enforcement Standard
- NR 140 PAL = Wisconsin Administrative Code, Chapter NR 140 Preventive Action Limit
- FP = Free Product in well - no sample collected
- Laboratory flags:
 - "L" = Concentration flagged by laboratory as common lab solvent and contaminant
 - "J" = Concentration reported between Method Detection Limit and Limit of Quantitation
 - "Q" = Unquantitated hydrocarbons present in the sample outside of the reported carbon range (lab indicated these are late end petroleum hydrocarbon peaks)
- Exceedances:
 - [] = Concentration exceeds NR 140 ES
 - () = Concentration exceeds NR 140 PAL
- Trip blank results:
 - 12/19/01 - All PVOCs reported below laboratory detection limits
 - 3/17/03 - All PVOCs reported below laboratory detection limits
 - 12/30/03 - All PVOCs reported below laboratory detection limits
 - 4/13/06 - All PVOCs reported below laboratory detection limits
 - 2/25/09 & 2/26/09 - All PVOCs reported below laboratory detection limits
 - 3/21/11 - All PVOCs reported below laboratory detection limits
 - 8/4/11 - All PVOCs reported below laboratory detection limits
 - 11/4/11 - All PVOCs reported below laboratory detection limits
 - 6/7/12 - All PVOCs reported below laboratory detection limits
- Equipment blank results:
 - 12/19/01 - All PVOCs reported below laboratory detection limits, except for toluene reported at 0.22 µg/l in 1 blank (2 equipment blanks used this event)
 - 3/17/03 - All PVOCs reported below laboratory detection limits
 - 12/30/03 - Not used, as new disposable bailers used at each well to collect groundwater samples
 - 4/13/06 - All PVOCs reported below laboratory detection limits, except benzene (1.3 µg/L) and toluene (0.62 µg/L). Benzene was not detected at low levels in any samples, but toluene was detected at low levels in well MW-15.
 - 2/25/09 & 2/26/09 - All PVOCs reported below laboratory detection limits
 - 3/21/11 - All PVOCs reported below laboratory detection limits
 - 8/4/11 - All PVOCs reported below laboratory detection limits, except toluene (0.47 "J" µg/L). Toluene was not detected at this low of level in any samples.
 - 11/4/11 - All PVOCs reported below laboratory detection limits
 - 6/7/12 - All PVOCs reported below laboratory detection limits

Table 3
Groundwater Quality Results
Jacobus Bulk Plant / Retail Station (Former) - 111 E. Decorah Road, West Bend, Wisconsin
Project Reference #6662

Sample Location:		MW-16																		NR 140	NR 140	
Sample Date:		1/30/96	3/6/96	8/8/96	2/5/97	6/18/97	11/20/98	5/20/99	11/10/99	12/19/01	3/17/03	12/30/03	4/13/06	2/25/09	2/09 Dup	3/21/11	8/4/11	11/4/11	6/7/12	ES	PAL	
PVOCs		Units																				
Benzene	µg/l	[517]	[8,590]	[5,440]	[4,500]	[4,000]	[4,900]	[1,100]	[4,000]	[3,000]	[972]	[708]	FP	[410]	390	[78 "J"]	[250]	[140]	[178]	5	0.5	
Ethylbenzene	µg/l	[1,430]	[1,280]	[1,260]	[2,400]	[1,800]	[1,700]	[800]	[1,900]	[1,600]	[1,600]	[765]	FP	[2,100]	1,800	[710]	[740]	[1,200]	[1,220]	700	140	
Methyl tert Butyl Ether	µg/l	[105]	[68]	[55]	[55]	<60	(35)	<10	<20	<6.4	<100	7.70	FP	<4.6	<4.6	<9.2	<4.6	<2.3	<40	60	12	
Toluene	µg/l	(380)	(766)	(200)	[850]	<40	80	<10	(190)	(160)	<250	<250	FP	9.6 "J"	10 "J"	<10	21 "J"	18 "J"	47 "J"	800	160	
1,2,4-Trimethylbenzene	µg/l	790	705	598	1,400	1,100	1,000	500	1,100	960	1,050	842	FP	3,000	2,100	2,500	1,700	1,500	2,550	NS	NS	
1,3,5-Trimethylbenzene	µg/l	160	136	122	340	460	750	140	310	210	<500	160	FP	690	500	1,100	590	310	550	NS	NS	
Total Trimethylbenzene	µg/l	[950]	[841]	[720]	[1,740]	[1,560]	[1,750]	[640]	[1,410]	[1,170]	[1,050]	[1,002]	FP	[3,690]	2,600	[3,600]	[2,290]	[1,810]	[3,100]	480	96	
Total Xylenes	µg/l	[7,990]	[6,550]	[6,740]	[13,800]	[10,600]	[10,000]	[3,310]	[10,000]	[6,900]	[5,070]	[2,170]	FP	[5,400]	5,100	[2,600]	(1,800)	(1,800)	[2,510]	2,000	400	
Detected VOCs																						
n-Butylbenzene	µg/l	NA	NA	NA	NA	NA	NA	NA	NA	NA	NA	NA	NA	NA	NA	NA	NA	NA	NA	NA	NS	NS
Chloroform	µg/l	NA	NA	NA	NA	NA	NA	NA	NA	NA	NA	NA	NA	NA	NA	NA	NA	NA	NA	NA	6	0.6
Chloromethane	µg/l	NA	NA	NA	NA	NA	NA	NA	NA	NA	NA	NA	NA	NA	NA	NA	NA	NA	NA	NA	30	3
Isopropylbenzene	µg/l	NA	NA	NA	NA	NA	NA	NA	NA	NA	NA	NA	NA	NA	NA	NA	NA	NA	NA	NA	NS	NS
Methylene Chloride	µg/l	NA	NA	NA	NA	NA	NA	NA	NA	NA	NA	NA	NA	NA	NA	NA	NA	NA	NA	NA	5	0.5
n-Propylbenzene	µg/l	NA	NA	NA	NA	NA	NA	NA	NA	NA	NA	NA	NA	NA	NA	NA	NA	NA	NA	NA	NS	NS
Naphthalene	µg/l	NA	NA	NA	NA	NA	NA	NA	NA	NA	NA	NA	[202]	FP	[350]	NA	[240]	[260]	[390]	[360]	100	10
Dissolved Metals																						
Lead	µg/l	NA	NA	NA	NA	NA	NA	NA	NA	NA	NA	NA	NA	NA	NA	NA	NA	NA	NA	NA	15	1.5

Notes:

- µg/l = micrograms per liter (equivalent to parts per billion, ppb)
- NR 140 ES = Wisconsin Administrative Code, Chapter NR 140 Enforcement Standard
- NR 140 PAL = Wisconsin Administrative Code, Chapter NR 140 Preventive Action Limit
- FP = Free Product in well - no sample collected
- Laboratory flags:
 - "L" = Concentration flagged by laboratory as common lab solvent and contaminant
 - "J" = Concentration reported between Method Detection Limit and Limit of Quantitation
 - "Q" = Unquantitated hydrocarbons present in the sample outside of the reported carbon range (lab indicated these are late end petroleum hydrocarbon peaks)
- Exceedances:
 - [] = Concentration exceeds NR 140 ES
 - () = Concentration exceeds NR 140 PAL
- Trip blank results:
 - 12/19/01 - All PVOCs reported below laboratory detection limits
 - 3/17/03 - All PVOCs reported below laboratory detection limits
 - 12/30/03 - All PVOCs reported below laboratory detection limits
 - 4/13/06 - All PVOCs reported below laboratory detection limits
 - 2/25/09 & 2/26/09 - All PVOCs reported below laboratory detection limits
 - 3/21/11 - All PVOCs reported below laboratory detection limits
 - 8/4/11 - All PVOCs reported below laboratory detection limits
 - 11/4/11 - All PVOCs reported below laboratory detection limits
 - 6/7/12 - All PVOCs reported below laboratory detection limits
- Equipment blank results:
 - 12/19/01 - All PVOCs reported below laboratory detection limits, except for toluene reported at 0.22 µg/l in 1 blank (2 equipment blanks used this event)
 - 3/17/03 - All PVOCs reported below laboratory detection limits
 - 12/30/03 - Not used, as new disposable bailers used at each well to collect groundwater samples
 - 4/13/06 - All PVOCs reported below laboratory detection limits, except benzene (1.3 µg/L) and toluene (0.62 µg/L). Benzene was not detected at low levels in any samples, but toluene was detected at low levels in well MW-15.
 - 2/25/09 & 2/26/09 - All PVOCs reported below laboratory detection limits
 - 3/21/11 - All PVOCs reported below laboratory detection limits
 - 8/4/11 - All PVOCs reported below laboratory detection limits, except toluene (0.47 "J" µg/L). Toluene was not detected at this low level in any samples.
 - 11/4/11 - All PVOCs reported below laboratory detection limits
 - 6/7/12 - All PVOCs reported below laboratory detection limits

Table 3
Groundwater Quality Results
Jacobus Bulk Plant / Retail Station (Former) - 111 E. Decorah Road, West Bend, Wisconsin
Project Reference #6662

Sample Location:		MW-17																	NR 140	NR 140
Sample Date:		1/30/96	3/6/96	8/8/96	2/5/97	6/18/97	11/19/98	5/20/99	12/19/01	3/17/03	12/30/03	4/13/06	2/25/09	3/21/11	8/4/11	11/4/11	6/7/12	ES	PAL	
PVOCs																				
Units																				
Benzene	µg/l	ND	ND	ND	ND	ND	ND	ND	ND	<0.13	<0.500	<0.500	<0.20	<0.25	<0.25	NA	<0.25	NA	5	0.5
Ethylbenzene	µg/l	ND	ND	ND	ND	0.2	ND	ND	ND	<0.22	<0.500	<5.00	<0.50	<0.22	<0.22	NA	<0.22	NA	700	140
Methyl tert Butyl Ether	µg/l	ND	ND	ND	ND	ND	ND	ND	ND	<0.16	<0.200	<0.146	<0.50	<0.23	<0.23	NA	<0.23	NA	60	12
Toluene	µg/l	ND	ND	ND	ND	ND	ND	ND	0.6 "J"	<0.20	<0.500	<5.00	<0.20	<0.25	<0.25	NA	<0.25	NA	800	160
1,2,4-Trimethylbenzene	µg/l	ND	ND	ND	ND	ND	ND	ND	ND	<0.22	<1.00	<5.00	<0.20	<0.25	<0.25	NA	<0.25	NA	NS	NS
1,3,5-Trimethylbenzene	µg/l	ND	ND	ND	ND	ND	ND	ND	ND	<0.29	<1.00	<5.00	<0.20	<0.19	<0.19	NA	<0.19	NA	NS	NS
Total Trimethylbenzene	µg/l	ND	ND	ND	ND	ND	ND	ND	ND	<0.51	<2.00	<10.00	<0.40	<0.44	<0.44	NA	<0.44	NA	480	96
Total Xylenes	µg/l	ND	ND	ND	ND	ND	ND	ND	ND	<0.23	<0.500	<5.00	<0.50	<0.39	<0.39	NA	<0.39	NA	2,000	400
Detected VOCs																				
n-Butylbenzene	µg/l	NA	NA	NA	NA	NA	NA	NA	NA	NA	NA	NA	NA	NA	NA	NA	NA	NA	NS	NS
Chloroform	µg/l	NA	NA	NA	NA	NA	NA	NA	NA	NA	NA	NA	NA	NA	NA	NA	NA	NA	6	0.6
Chloromethane	µg/l	NA	NA	NA	NA	NA	NA	NA	NA	NA	NA	NA	NA	NA	NA	NA	NA	NA	30	3
Isopropylbenzene	µg/l	NA	NA	NA	NA	NA	NA	NA	NA	NA	NA	NA	NA	NA	NA	NA	NA	NA	NS	NS
Methylene Chloride	µg/l	NA	NA	NA	NA	NA	NA	NA	NA	NA	NA	NA	NA	NA	NA	NA	NA	NA	5	0.5
n-Propylbenzene	µg/l	NA	NA	NA	NA	NA	NA	NA	NA	NA	NA	NA	NA	NA	NA	NA	NA	NA	NS	NS
Naphthalene	µg/l	NA	NA	NA	NA	NA	NA	NA	NA	NA	NA	<8.00	<0.25	<0.50	<0.50	NA	<0.50	NA	100	10
Dissolved Metals																				
Lead	µg/l	NA	NA	NA	NA	NA	NA	NA	NA	NA	NA	NA	NA	NA	NA	NA	NA	NA	15	1.5

Notes:

- µg/l = micrograms per liter (equivalent to parts per billion, ppb)
- NR 140 ES = Wisconsin Administrative Code, Chapter NR 140 Enforcement Standard
- NR 140 PAL = Wisconsin Administrative Code, Chapter NR 140 Preventive Action Limit
- FP = Free Product in well - no sample collected
- Laboratory flags:
 - "L" = Concentration flagged by laboratory as common lab solvent and contaminant
 - "J" = Concentration reported between Method Detection Limit and Limit of Quantitation
 - "Q" = Unquantitated hydrocarbons present in the sample outside of the reported carbon range (lab indicated these are late end petroleum hydrocarbon peaks)
- Exceedances:
 - [] = Concentration exceeds NR 140 ES
 - () = Concentration exceeds NR 140 PAL
- Trip blank results:
 - 12/19/01 - All PVOCs reported below laboratory detection limits
 - 3/17/03 - All PVOCs reported below laboratory detection limits
 - 12/30/03 - All PVOCs reported below laboratory detection limits
 - 4/13/06 - All PVOCs reported below laboratory detection limits
 - 2/25/09 & 2/26/09 - All PVOCs reported below laboratory detection limits
 - 3/21/11 - All PVOCs reported below laboratory detection limits
 - 8/4/11 - All PVOCs reported below laboratory detection limits
 - 11/4/11 - All PVOCs reported below laboratory detection limits
 - 6/7/12 - All PVOCs reported below laboratory detection limits
- Equipment blank results:
 - 12/19/01 - All PVOCs reported below laboratory detection limits, except for toluene reported at 0.22 µg/l in 1 blank (2 equipment blanks used this event)
 - 3/17/03 - All PVOCs reported below laboratory detection limits
 - 12/30/03 - Not used, as new disposable bailers used at each well to collect groundwater samples
 - 4/13/06 - All PVOCs reported below laboratory detection limits, except benzene (1.3 µg/L) and toluene (0.62 µg/L). Benzene was not detected at low levels in any samples, but toluene was detected at low levels in well MW-15.
 - 2/25/09 & 2/26/09 - All PVOCs reported below laboratory detection limits
 - 3/21/11 - All PVOCs reported below laboratory detection limits
 - 8/4/11 - All PVOCs reported below laboratory detection limits, except toluene (0.47 "J" µg/L). Toluene was not detected at this low of level in any samples.
 - 11/4/11 - All PVOCs reported below laboratory detection limits
 - 6/7/12 - All PVOCs reported below laboratory detection limits

Table 3
Groundwater Quality Results
Jacobus Bulk Plant / Retail Station (Former) - 111 E. Decorah Road, West Bend, Wisconsin
Project Reference #6662

Sample Location:		MW-18																		NR 140	NR 140
Sample Date:		1/30/96	3/6/96	8/8/96	2/5/97	6/18/97	11/20/98	5/20/99	11/10/99	12/19/01	3/17/03	12/30/03	4/13/06	4/06 Dup	2/25/09	3/21/11	8/4/11	11/4/11	6/7/12	ES	PAL
PVOCs																					
	Units																				
Benzene	µg/l	[7,880]	[6,170]	[7,370]	[3,800]	[4,600]	[1,900]	[1,800]	[1,400]	[1,500]	[1,550]	[1,230]	[600]	630	[310]	[68]	[410]	[160]	[175]	5	0.5
Ethylbenzene	µg/l	[1,910]	[1,270]	[1,390]	[1,100]	[950]	[950]	[900]	[750]	[840]	[1,490]	[1,380]	[620]	690	[1,500]	[1,000]	[1,100]	[920]	[1,310]	700	140
Methyl tert Butyl Ether	µg/l	[72]	[64]	[110]	[80]	[70]	(15)	(15)	<10	<1.6	<10.0	8.40	<5.0	<5.0	<2.3	<4.6	<4.6	<2.3	<8	60	12
Toluene	µg/l	(260)	56	71	ND	45	ND	<10	40	14	87.4	<250	7.3	7.7	60	17 "J"	26 "J"	9.8 "J"	26.4	800	160
1,2,4-Trimethylbenzene	µg/l	850	648	675	690	500	600	470	550	600	890	977	540	570	1,200	750	910	590	1,020	NS	NS
1,3,5-Trimethylbenzene	µg/l	160	106	154	70	150	240	80	120	130	183	193	36	40	78	<3.8	21 "J"	3.9 "J"	<7.4	NS	NS
Total Trimethylbenzene	µg/l	[1,010]	[754]	[829]	[760]	[650]	[840]	[550]	[670]	[730]	[1,073]	[1,170]	[576]	610	[1,278]	[780]	[931]	[593.9]	[1,020]	480	96
Total Xylenes	µg/l	[8,160]	[5,046]	[4,314]	[2,910]	[3,000]	[3,235]	[2,835]	[3,000]	[2,800]	[4,880]	[3,390]	(850)	980	(1,800)	(1,200)	(1,300)	(1,000)	(1,401.7)	2,000	400
Detected VOCs																					
n-Butylbenzene	µg/l	NA	NA	NA	NA	NA	NA	NA	NA	NA	NA	NA	NA	NA	NA	NA	NA	NA	NA	NS	NS
Chloroform	µg/l	NA	NA	NA	NA	NA	NA	NA	NA	NA	NA	NA	NA	NA	NA	NA	NA	NA	NA	6	0.6
Chloromethane	µg/l	NA	NA	NA	NA	NA	NA	NA	NA	NA	NA	NA	NA	NA	NA	NA	NA	NA	NA	30	3
Isopropylbenzene	µg/l	NA	NA	NA	NA	NA	NA	NA	NA	NA	NA	NA	NA	NA	NA	NA	NA	NA	NA	NS	NS
Methylene Chloride	µg/l	NA	NA	NA	NA	NA	NA	NA	NA	NA	NA	NA	NA	NA	NA	NA	NA	NA	NA	5	0.5
n-Propylbenzene	µg/l	NA	NA	NA	NA	NA	NA	NA	NA	NA	NA	NA	NA	NA	NA	NA	NA	NA	NA	NS	NS
Naphthalene	µg/l	NA	NA	NA	NA	NA	NA	NA	NA	NA	NA	[222]	(68)	74	[170]	[140]	[180]	[110]	[199]	100	10
Dissolved Metals																					
Lead	µg/l	NA	NA	NA	NA	NA	NA	NA	NA	NA	NA	NA	NA	NA	NA	NA	NA	NA	NA	15	1.5

Notes:

- µg/l = micrograms per liter (equivalent to parts per billion, ppb)
- NR 140 ES = Wisconsin Administrative Code, Chapter NR 140 Enforcement Standard
- NR 140 PAL = Wisconsin Administrative Code, Chapter NR 140 Preventive Action Limit
- FP = Free Product in well - no sample collected
- Laboratory flags:
 - "L" = Concentration flagged by laboratory as common lab solvent and contaminant
 - "J" = Concentration reported between Method Detection Limit and Limit of Quantitation
 - "Q" = Unquantitated hydrocarbons present in the sample outside of the reported carbon range (lab indicated these are late end petroleum hydrocarbon peaks)
- Exceedances:
 - [] = Concentration exceeds NR 140 ES
 - () = Concentration exceeds NR 140 PAL
- Trip blank results:
 - 12/19/01 - All PVOCs reported below laboratory detection limits
 - 3/17/03 - All PVOCs reported below laboratory detection limits
 - 12/30/03 - All PVOCs reported below laboratory detection limits
 - 4/13/06 - All PVOCs reported below laboratory detection limits
 - 2/25/09 & 2/26/09 - All PVOCs reported below laboratory detection limits
 - 3/21/11 - All PVOCs reported below laboratory detection limits
 - 8/4/11 - All PVOCs reported below laboratory detection limits
 - 11/4/11 - All PVOCs reported below laboratory detection limits
 - 6/7/12 - All PVOCs reported below laboratory detection limits
- Equipment blank results:
 - 12/19/01 - All PVOCs reported below laboratory detection limits, except for toluene reported at 0.22 µg/l in 1 blank (2 equipment blanks used this event)
 - 3/17/03 - All PVOCs reported below laboratory detection limits
 - 12/30/03 - Not used, as new disposable bailers used at each well to collect groundwater samples
 - 4/13/06 - All PVOCs reported below laboratory detection limits, except benzene (1.3 µg/L) and toluene (0.62 µg/L). Benzene was not detected at low levels in any samples, but toluene was detected at low levels in well MW 15.
 - 2/25/09 & 2/26/09 - All PVOCs reported below laboratory detection limits
 - 3/21/11 - All PVOCs reported below laboratory detection limits
 - 8/4/11 - All PVOCs reported below laboratory detection limits, except toluene (0.47 "J" µg/L). Toluene was not detected at this low level in any samples.
 - 11/4/11 - All PVOCs reported below laboratory detection limits
 - 6/7/12 - All PVOCs reported below laboratory detection limits

Table 3
Groundwater Quality Results
Jacobus Bulk Plant / Retail Station (Former) - 111 E. Decorah Road, West Bend, Wisconsin
Project Reference #6662

Sample Location:		MW-19																NR 140	NR 140	
Sample Date:		1/30/96	3/6/96	8/8/96	2/5/97	6/18/97	11/19/98	5/20/99	11/10/99	12/19/01	3/17/03	12/30/03	4/13/06	2/25/09	3/21/11	8/4/11	11/4/11	6/7/12	ES	PAL
PVOCs	Units																			
Benzene	µg/l	ND	ND	0.4	0.2	ND	ND	ND	ND	<0.13	<0.500	<0.500	<0.20	<0.25	<0.25	NA	<0.25	NA	5	0.5
Ethylbenzene	µg/l	ND	ND	ND	ND	0.2	ND	ND	ND	<0.22	<0.500	<5.00	<0.50	<0.22	<0.22	NA	<0.22	NA	700	140
Methyl tert Butyl Ether	µg/l	ND	ND	ND	ND	ND	ND	0.3	ND	<0.16	0.327	0.222	<0.50	0.32 "J"	<0.23	NA	<0.23	NA	60	12
Toluene	µg/l	ND	ND	ND	ND	ND	ND	ND	ND	<0.20	<0.500	<5.00	<0.20	<0.25	<0.25	NA	<0.25	NA	800	160
1,2,4-Trimethylbenzene	µg/l	ND	ND	ND	ND	0.4	ND	ND	ND	<0.22	<1.00	<5.00	<0.20	<0.25	<0.25	NA	<0.25	NA	NS	NS
1,3,5-Trimethylbenzene	µg/l	ND	ND	ND	ND	ND	ND	ND	ND	<0.29	<1.00	<5.00	<0.20	<0.19	<0.19	NA	<0.19	NA	NS	NS
Total Trimethylbenzene	µg/l	ND	ND	ND	ND	0.4	ND	ND	ND	<0.51	<2.00	<10.00	<0.40	<0.44	<0.44	NA	<0.44	NA	480	96
Total Xylenes	µg/l	ND	ND	ND	ND	ND	ND	ND	ND	<0.23	<0.500	<5.00	<0.50	<0.39	<0.39	NA	<0.39	NA	2,000	400
Detected VOCs																				
n-Butylbenzene	µg/l	NA	NA	NA	NA	NA	NA	NA	NA	NA	NA	NA	NA	NA	NA	NA	NA	NA	NS	NS
Chloroform	µg/l	NA	NA	NA	NA	NA	NA	NA	NA	NA	NA	NA	NA	NA	NA	NA	NA	NA	6	0.6
Chloromethane	µg/l	NA	NA	NA	NA	NA	NA	NA	NA	NA	NA	NA	NA	NA	NA	NA	NA	NA	30	3
Isopropylbenzene	µg/l	NA	NA	NA	NA	NA	NA	NA	NA	NA	NA	NA	NA	NA	NA	NA	NA	NA	NS	NS
Methylene Chloride	µg/l	NA	NA	NA	NA	NA	NA	NA	NA	NA	NA	NA	NA	NA	NA	NA	NA	NA	5	0.5
n-Propylbenzene	µg/l	NA	NA	NA	NA	NA	NA	NA	NA	NA	NA	NA	NA	NA	NA	NA	NA	NA	NS	NS
Naphthalene	µg/l	NA	NA	NA	NA	NA	NA	NA	NA	NA	NA	<8.00	<0.25	<0.50	<0.50	NA	<0.50	NA	100	10
Dissolved Metals																				
Lead	µg/l	NA	NA	NA	NA	NA	NA	NA	NA	NA	NA	NA	NA	NA	NA	NA	NA	NA	15	1.5

Notes:

- µg/l = micrograms per liter (equivalent to parts per billion, ppb)
- NR 140 ES = Wisconsin Administrative Code, Chapter NR 140 Enforcement Standard
- NR 140 PAL = Wisconsin Administrative Code, Chapter NR 140 Preventive Action Limit
- FP = Free Product in well - no sample collected
- Laboratory flags:
 - "L" = Concentration flagged by laboratory as common lab solvent and contaminant
 - "J" = Concentration reported between Method Detection Limit and Limit of Quantitation
 - "Q" = Unquantitated hydrocarbons present in the sample outside of the reported carbon range (lab indicated these are late end petroleum hydrocarbon peaks)
- Exceedances:
 - [] = Concentration exceeds NR 140 ES
 - () = Concentration exceeds NR 140 PAL
- Trip blank results:
 - 12/19/01 - All PVOCs reported below laboratory detection limits
 - 3/17/03 - All PVOCs reported below laboratory detection limits
 - 12/30/03 - All PVOCs reported below laboratory detection limits
 - 4/13/06 - All PVOCs reported below laboratory detection limits
 - 2/25/09 & 2/26/09 - All PVOCs reported below laboratory detection limits
 - 3/21/11 - All PVOCs reported below laboratory detection limits
 - 8/4/11 - All PVOCs reported below laboratory detection limits
 - 11/4/11 - All PVOCs reported below laboratory detection limits
 - 6/7/12 - All PVOCs reported below laboratory detection limits
- Equipment blank results:
 - 12/19/01 - All PVOCs reported below laboratory detection limits, except for toluene reported at 0.22 µg/l in 1 blank (2 equipment blanks used this event)
 - 3/17/03 - All PVOCs reported below laboratory detection limits
 - 12/30/03 - Not used, as new disposable bailers used at each well to collect groundwater samples
 - 4/13/06 - All PVOCs reported below laboratory detection limits, except benzene (1.3 µg/L) and toluene (0.62 µg/L). Benzene was not detected at low levels in any samples, but toluene was detected at low levels in well MW-15.
 - 2/25/09 & 2/26/09 - All PVOCs reported below laboratory detection limits
 - 3/21/11 - All PVOCs reported below laboratory detection limits
 - 8/4/11 - All PVOCs reported below laboratory detection limits, except toluene (0.47 "J" µg/L). Toluene was not detected at this low level in any samples.
 - 11/4/11 - All PVOCs reported below laboratory detection limits
 - 6/7/12 - All PVOCs reported below laboratory detection limits

Table 3
Groundwater Quality Results
Jacobus Bulk Plant / Retail Station (Former) - 111 E. Decorah Road, West Bend, Wisconsin
Project Reference #6662

Sample Location:		MW-20																NR 140	NR 140	
Sample Date:		1/30/96	3/6/96	8/8/96	2/5/97	6/18/97	11/19/98	5/20/99	11/10/99	12/19/01	3/17/03	12/30/03	4/13/06	2/25/09	3/21/11	8/4/11	11/4/11	6/7/12	ES	PAL
PVOCs	Units																			
Benzene	µg/l	ND	ND	ND	ND	ND	ND	ND	ND	<0.13	<0.500	<0.500	<0.20	<0.25	<0.25	NA	<0.25	NA	5	0.5
Ethylbenzene	µg/l	ND	ND	ND	ND	ND	ND	ND	ND	<0.22	<0.500	<5.00	<0.50	<0.22	<0.22	NA	<0.22	NA	700	140
Methyl tert Butyl Ether	µg/l	ND	ND	ND	ND	ND	ND	ND	ND	<0.16	<0.200	<0.146	<0.50	<0.23	<0.23	NA	<0.23	NA	60	12
Toluene	µg/l	ND	ND	ND	ND	ND	ND	ND	ND	<0.20	<0.500	<5.00	<0.20	<0.25	<0.25	NA	<0.25	NA	800	160
1,2,4-Trimethylbenzene	µg/l	ND	ND	ND	ND	ND	ND	ND	ND	<0.22	<1.00	<5.00	<0.20	<0.25	<0.25	NA	<0.25	NA	NS	NS
1,3,5-Trimethylbenzene	µg/l	ND	ND	ND	ND	ND	ND	ND	ND	<0.29	<1.00	<5.00	<0.20	<0.19	<0.19	NA	<0.19	NA	NS	NS
Total Trimethylbenzene	µg/l	ND	ND	ND	ND	ND	ND	ND	ND	<0.51	<2.00	<10.00	<0.40	<0.44	<0.44	NA	<0.44	NA	480	96
Total Xylenes	µg/l	ND	ND	ND	ND	ND	ND	ND	ND	<0.23	<0.500	<5.00	<0.50	<0.39	<0.39	NA	<0.39	NA	2,000	400
Detected VOCs																				
n-Butylbenzene	µg/l	NA	NA	NA	NA	NA	NA	NA	NA	NA	NA	NA	NA	NA	NA	NA	NA	NA	NS	NS
Chloroform	µg/l	NA	NA	NA	NA	NA	NA	NA	NA	NA	NA	NA	NA	NA	NA	NA	NA	NA	6	0.6
Chloromethane	µg/l	NA	NA	NA	NA	NA	NA	NA	NA	NA	NA	NA	NA	NA	NA	NA	NA	NA	30	3
Isopropylbenzene	µg/l	NA	NA	NA	NA	NA	NA	NA	NA	NA	NA	NA	NA	NA	NA	NA	NA	NA	NS	NS
Methylene Chloride	µg/l	NA	NA	NA	NA	NA	NA	NA	NA	NA	NA	NA	NA	NA	NA	NA	NA	NA	5	0.5
n-Propylbenzene	µg/l	NA	NA	NA	NA	NA	NA	NA	NA	NA	NA	NA	NA	NA	NA	NA	NA	NA	NS	NS
Naphthalene	µg/l	NA	NA	NA	NA	NA	NA	NA	NA	NA	NA	<8.00	<0.25	<0.50	<0.50	NA	<0.50	NA	100	10
Dissolved Metals																				
Lead	µg/l	NA	NA	NA	NA	NA	NA	NA	NA	NA	NA	NA	NA	NA	NA	NA	NA	NA	15	1.5

Notes:

- µg/l = micrograms per liter (equivalent to parts per billion, ppb)
- NR 140 ES = Wisconsin Administrative Code, Chapter NR 140 Enforcement Standard
- NR 140 PAL = Wisconsin Administrative Code, Chapter NR 140 Preventive Action Limit
- FP = Free Product in well - no sample collected
- Laboratory flags:
 - "L" = Concentration flagged by laboratory as common lab solvent and contaminant
 - "J" = Concentration reported between Method Detection Limit and Limit of Quantitation
 - "Q" = Unquantitated hydrocarbons present in the sample outside of the reported carbon range (lab indicated these are late end petroleum hydrocarbon peaks)
- Exceedances:
 - [] = Concentration exceeds NR 140 ES
 - () = Concentration exceeds NR 140 PAL
- Trip blank results:
 - 12/19/01 - All PVOCs reported below laboratory detection limits
 - 3/17/03 - All PVOCs reported below laboratory detection limits
 - 12/30/03 - All PVOCs reported below laboratory detection limits
 - 4/13/06 - All PVOCs reported below laboratory detection limits
 - 2/25/09 & 2/26/09 - All PVOCs reported below laboratory detection limits
 - 3/21/11 - All PVOCs reported below laboratory detection limits
 - 8/4/11 - All PVOCs reported below laboratory detection limits
 - 11/4/11 - All PVOCs reported below laboratory detection limits
 - 6/7/12 - All PVOCs reported below laboratory detection limits
- Equipment blank results:
 - 12/19/01 - All PVOCs reported below laboratory detection limits, except for toluene reported at 0.22 µg/l in 1 blank (2 equipment blanks used this event)
 - 3/17/03 - All PVOCs reported below laboratory detection limits
 - 12/30/03 - Not used, as new disposable bailers used at each well to collect groundwater samples
 - 4/13/06 - All PVOCs reported below laboratory detection limits, except benzene (1.3 µg/L) and toluene (0.62 µg/L). Benzene was not detected at low levels in any samples, but toluene was detected at low levels in well MW-15.
 - 2/25/09 & 2/26/09 - All PVOCs reported below laboratory detection limits
 - 3/21/11 - All PVOCs reported below laboratory detection limits
 - 8/4/11 - All PVOCs reported below laboratory detection limits, except toluene (0.47 "J" µg/L). Toluene was not detected at this low level in any samples.
 - 11/4/11 - All PVOCs reported below laboratory detection limits
 - 6/7/12 - All PVOCs reported below laboratory detection limits

Table 3
Groundwater Quality Results
Jacobus Bulk Plant / Retail Station (Former) - 111 E. Decorah Road, West Bend, Wisconsin
Project Reference #6662

Sample Location:		MW-21										MW-22						NR 140	NR 140
Sample Date:		12/19/01	3/17/03	12/30/03	4/13/06	2/25/09	3/21/11	8/4/11	11/4/11	6/7/12	2/25/09	3/21/11	3/11 Dup	8/4/11	11/4/11	6/7/12	ES	PAL	
PVOCs		Units																	
Benzene	µg/l	<0.10	<0.500	<0.500	<0.20	<0.25	<0.25	NA	<0.25	NA	[160]	[22]	30	[27]	[46]	[11.4 "J"]	5	0.5	
Ethylbenzene	µg/l	<0.25	<0.500	<5.00	<0.50	<0.22	<0.22	NA	<0.22	NA	[800]	[750]	610	(660)	(680)	(630)	700	140	
Methyl tert Butyl Ether	µg/l	<0.25	<0.200	<0.146	<0.50	<0.23	<0.23	NA	<0.23	NA	<5.0	<0.92	<2.3	3.9 "J"	<1.8	<8	60	12	
Toluene	µg/l	0.15	<0.500	<5.00	<0.20	<0.25	<0.25	NA	<0.25	NA	16 "J"	7.8 "J"	7.6 "J"	29	24	6.5 "J"	800	160	
1,2,4-Trimethylbenzene	µg/l	<0.10	<1.00	<5.00	<0.20	<0.25	<0.25	NA	<0.25	NA	430	310	230	340	450	470	NS	NS	
1,3,5-Trimethylbenzene	µg/l	<0.10	<1.00	<5.00	<0.20	<0.19	<0.19	NA	<0.19	NA	64	18	9.3 "J"	33	38	40	NS	NS	
Total Trimethylbenzene	µg/l	<0.20	<2.00	<10.00	<0.40	<0.44	<0.44	NA	<0.44	NA	[494]	[328]	239.3	(373)	[488]	[510]	480	96	
Total Xylenes	µg/l	<0.25	<0.500	<5.00	<0.50	<0.39	<0.39	NA	<0.39	NA	[2,100]	[2,100]	1,700	(1,300)	(1,500)	(1,112)	2,000	400	
Detected VOCs																			
n-Butylbenzene	µg/l	<0.25	NA	NA	NA	NA	NA	NA	NA	NA	<2.0	NA	NA	NA	NA	NA	NS	NS	
Chloroform	µg/l	<0.25	NA	NA	NA	NA	NA	NA	NA	NA	(3.3 "J")	NA	NA	NA	NA	NA	6	0.6	
Chloromethane	µg/l	1.4	NA	NA	NA	NA	NA	NA	NA	NA	NA	NA	NA	NA	NA	NA	30	3	
Isopropylbenzene	µg/l	<0.25	NA	NA	NA	NA	NA	NA	NA	NA	22	NA	NA	NA	NA	NA	NS	NS	
Methylene Chloride	µg/l	(2.0 "L")	NA	NA	NA	NA	NA	NA	NA	NA	NA	NA	NA	NA	NA	NA	5	0.5	
n-Propylbenzene	µg/l	<0.25	NA	NA	NA	NA	NA	NA	NA	NA	56	NA	NA	NA	NA	NA	NS	NS	
Naphthalene	µg/l	<0.25	NA	<8.00	<0.25	<0.50	<0.50	NA	<0.50	NA	[110]	(42)	NA	(81)	(80)	[100]	100	10	
Dissolved Metals																			
Lead	µg/l	NA	NA	NA	NA	NA	NA	NA	NA	NA	NA	NA	NA	NA	NA	NA	15	1.5	

Notes:

- µg/l = micrograms per liter (equivalent to parts per billion, ppb)
- NR 140 ES = Wisconsin Administrative Code, Chapter NR 140 Enforcement Standard
- NR 140 PAL = Wisconsin Administrative Code, Chapter NR 140 Preventive Action Limit
- FP = Free Product in well - no sample collected
- Laboratory flags:
 - "L" = Concentration flagged by laboratory as common lab solvent and contaminant
 - "J" = Concentration reported between Method Detection Limit and Limit of Quantitation
 - "Q" = Unquantitated hydrocarbons present in the sample outside of the reported carbon range (lab indicated these are late end petroleum hydrocarbon peaks)
- Exceedances:
 - [] = Concentration exceeds NR 140 ES
 - () = Concentration exceeds NR 140 PAL
- Trip blank results:
 - 12/19/01 - All PVOCs reported below laboratory detection limits
 - 3/17/03 - All PVOCs reported below laboratory detection limits
 - 12/30/03 - All PVOCs reported below laboratory detection limits
 - 4/13/06 - All PVOCs reported below laboratory detection limits
 - 2/25/09 & 2/26/09 - All PVOCs reported below laboratory detection limits
 - 3/21/11 - All PVOCs reported below laboratory detection limits
 - 8/4/11 - All PVOCs reported below laboratory detection limits
 - 11/4/11 - All PVOCs reported below laboratory detection limits
 - 6/7/12 - All PVOCs reported below laboratory detection limits
- Equipment blank results:
 - 12/19/01 - All PVOCs reported below laboratory detection limits, except for toluene reported at 0.22 µg/l in 1 blank (2 equipment blanks used this event)
 - 3/17/03 - All PVOCs reported below laboratory detection limits
 - 12/30/03 - Not used, as new disposable bailers used at each well to collect groundwater samples
 - 4/13/06 - All PVOCs reported below laboratory detection limits, except benzene (1.3 µg/L) and toluene (0.62 µg/L). Benzene was not detected at low levels in any samples, but toluene was detected at low levels in well MW-15.
 - 2/25/09 & 2/26/09 - All PVOCs reported below laboratory detection limits
 - 3/21/11 - All PVOCs reported below laboratory detection limits
 - 8/4/11 - All PVOCs reported below laboratory detection limits, except toluene (0.47 "J" µg/L). Toluene was not detected at this low level in any samples.
 - 11/4/11 - All PVOCs reported below laboratory detection limits
 - 6/7/12 - All PVOCs reported below laboratory detection limits

Table 3
Groundwater Quality Results
Jacobus Bulk Plant / Retail Station (Former) - 111 E. Decorah Road, West Bend, Wisconsin
Project Reference #6662

Sample Location:	MW-23	MW-24	MW-25	RW-1					RW-2					NR 140	NR 140	
	Sample Date:	6/7/12	6/7/12	6/7/12	4/27/93	9/29/93	12/30/93	3/23/94	6/9/94	4/27/93	9/29/93	12/30/93	3/23/94	6/9/94	ES	PAL
PVOCs	Units															
Benzene	µg/l	<0.5	<0.5	[32 "J"]	[1,700]	[2,600]	[870]	[930]	[1,600]	[1,600]	[6,200]	[1,400]	[1,600]	[1,600]	5	0.5
Ethylbenzene	µg/l	<0.78	<0.78	[4,200]	(610)	(600)	(220)	120	(400)	(430)	[2,400]	(440)	(280)	(560)	700	140
Methyl tert Butyl Ether	µg/l	<0.8	<0.8	<40	(17)	<50	<50	(12)	[240]	11	<25	<100	<100	<100	60	12
Toluene	µg/l	<0.53	<0.53	[15,300]	[5,800]	[14,000]	[2,600]	[3,700]	[4,700]	[5,300]	[34,000]	[5,100]	[4,800]	[5,700]	800	160
1,2,4-Trimethylbenzene	µg/l	<0.8	<0.8	2,780	880	2,800	710	1,300	1,100	260	1,900	450	370	300	NS	NS
1,3,5-Trimethylbenzene	µg/l	<0.74	<0.74	750	250	900	120	460	300	75	650	<100	<100	<100	NS	NS
Total Trimethylbenzene	µg/l	<1.54	<1.54	[3,530]	[1,130]	[3,700]	[830]	[1,760]	[1,400]	(335)	[2,550]	(450)	(370)	(300)	480	96
Total Xylenes	µg/l	<1.9	<1.9	[21,500]	[4,800]	[14,800]	[3,600]	[8,100]	[6,600]	[2,540]	[17,800]	[3,500]	[3,200]	[3,000]	2,000	400
Detected VOCs																
n-Butylbenzene	µg/l	<0.9	<0.9	52 "J"	NA	NA	NA	NA	NA	NA	NA	NA	NA	NA	NS	NS
Chloroform	µg/l	[9.3]	[11.6]	<24.5	NA	NA	NA	NA	NA	NA	NA	NA	NA	NA	6	0.6
Chloromethane	µg/l	<1.9	<1.9	<95	NA	NA	NA	NA	NA	NA	NA	NA	NA	NA	30	3
Isopropylbenzene	µg/l	<0.92	<0.92	104 "J"	NA	NA	NA	NA	NA	NA	NA	NA	NA	NA	NS	NS
Methylene Chloride	µg/l	<1.1	<1.1	<55	NA	NA	NA	NA	NA	NA	NA	NA	NA	NA	5	0.5
n-Propylbenzene	µg/l	<0.59	<0.59	330	NA	NA	NA	NA	NA	NA	NA	NA	NA	NA	NS	NS
Naphthalene	µg/l	<2.1	<2.1	[750]	NA	NA	NA	NA	NA	NA	NA	NA	NA	NA	100	10
Dissolved Metals																
Lead	µg/l	NA	NA	NA	NA	NA	NA	NA	NA	NA	NA	NA	NA	NA	15	1.5

Notes:

- µg/l = micrograms per liter (equivalent to parts per billion, ppb)
- NR 140 ES = Wisconsin Administrative Code, Chapter NR 140 Enforcement Standard
- NR 140 PAL = Wisconsin Administrative Code, Chapter NR 140 Preventive Action Limit
- FP = Free Product in well - no sample collected
- Laboratory flags:
 - "L" = Concentration flagged by laboratory as common lab solvent and contaminant
 - "J" = Concentration reported between Method Detection Limit and Limit of Quantitation
 - "Q" = Unquantitated hydrocarbons present in the sample outside of the reported carbon range (lab indicated these are late end petroleum hydrocarbon peaks)
- Exceedances:
 - [] = Concentration exceeds NR 140 ES
 - () = Concentration exceeds NR 140 PAL
- Trip blank results:
 - 12/19/01 - All PVOCs reported below laboratory detection limits
 - 3/17/03 - All PVOCs reported below laboratory detection limits
 - 12/30/03 - All PVOCs reported below laboratory detection limits
 - 4/13/06 - All PVOCs reported below laboratory detection limits
 - 2/25/09 & 2/26/09 - All PVOCs reported below laboratory detection limits
 - 3/21/11 - All PVOCs reported below laboratory detection limits
 - 8/4/11 - All PVOCs reported below laboratory detection limits
 - 11/4/11 - All PVOCs reported below laboratory detection limits
 - 6/7/12 - All PVOCs reported below laboratory detection limits
- Equipment blank results:
 - 12/19/01 - All PVOCs reported below laboratory detection limits, except for toluene reported at 0.22 µg/l in 1 blank (2 equipment blanks used this event)
 - 3/17/03 - All PVOCs reported below laboratory detection limits
 - 12/30/03 - Not used, as new disposable bailers used at each well to collect groundwater samples
 - 4/13/06 - All PVOCs reported below laboratory detection limits, except benzene (1.3 µg/L) and toluene (0.62 µg/L). Benzene was not detected at low levels in any samples, but toluene was detected at low levels in well MW-11
 - 2/25/09 & 2/26/09 - All PVOCs reported below laboratory detection limits
 - 3/21/11 - All PVOCs reported below laboratory detection limits
 - 8/4/11 - All PVOCs reported below laboratory detection limits, except toluene (0.47 "J" µg/L). Toluene was not detected at this low level in any samples.
 - 11/4/11 - All PVOCs reported below laboratory detection limits
 - 6/7/12 - All PVOCs reported below laboratory detection limits

Table 3
Groundwater Quality Results
Jacobus Bulk Plant / Retail Station (Former) - 111 E. Decorah Road, West Bend, Wisconsin
Project Reference #6662

Sample Location:		RW-3								RW-4								NR 140	NR 140
Sample Date:		4/27/93	9/29/93	12/30/93	3/23/94	6/9/94	9/14/94	12/8/94	4/10/96	4/27/93	9/20/93	12/30/93	3/23/94	6/9/94	9/14/94	12/8/94	2/26/09	ES	PAL
PVOCs																			
	Units																		
Benzene	µg/l	[8,300]	[4,200]	[8,700]	[3,700]	[4,700]	[7,600]	[8,100]	[5,420]	[820]	[190]	[460]	[420]	[130]	[340]	[340]	FP / [57 "Q"]	5	0.5
Ethylbenzene	µg/l	[940]	[1,300]	[1,000]	[1,800]	[750]	[1,200]	(630)	[1,020]	97	60	<100	17	12	21	17	FP / 93 "Q"	700	140
Methyl tert Butyl Ether	µg/l	[460]	<25	[2,900]	[300]	<500	NA	ND	(52)	[84]	<10	<100	(29)	<10	NA	(26)	FP / <2.3 "Q"	60	12
Toluene	µg/l	[16,000]	[24,000]	[19,000]	[11,000]	[11,000]	[17,000]	[21,000]	[16,700]	(580)	(300)	(350)	(240)	56	(260)	(430)	FP / (510 "Q")	800	160
1,2,4-Trimethylbenzene	µg/l	640	3,200	880	4,500	<500	NA	700	909	77	110	<100	54	43	NA	61	FP / 130 "Q"	NS	NS
1,3,5-Trimethylbenzene	µg/l	200	950	<200	1,000	<500	NA	ND	213	21	62	<100	11	14	NA	34	FP / 50 "Q"	NS	NS
Total Trimethylbenzene	µg/l	[840]	[4,150]	[880]	[5,500]	<1,000	NA	[700]	[1,122]	(98)	(172)	<200	65	57	NA	95	FP / (180)	480	96
Total Xylenes	µg/l	[6,100]	[19,500]	[7,800]	[12,200]	[4,300]	[9,300]	[7,200]	[7,900]	(470)	(600)	(430)	360	226	360	(560)	FP / (460 "Q")	2,000	400
Detected VOCs																			
n-Butylbenzene	µg/l	NA	NA	NA	NA	NA	NA	NA	NA	NA	NA	NA	NA	NA	NA	NA	NA	NS	NS
Chloroform	µg/l	NA	NA	NA	NA	NA	NA	NA	NA	NA	NA	NA	NA	NA	NA	NA	NA	6	0.6
Chloromethane	µg/l	NA	NA	NA	NA	NA	NA	NA	NA	NA	NA	NA	NA	NA	NA	NA	NA	30	3
Isopropylbenzene	µg/l	NA	NA	NA	NA	NA	NA	NA	NA	NA	NA	NA	NA	NA	NA	NA	NA	NS	NS
Methylene Chloride	µg/l	NA	NA	NA	NA	NA	NA	NA	NA	NA	NA	NA	NA	NA	NA	NA	NA	5	0.5
n-Propylbenzene	µg/l	NA	NA	NA	NA	NA	NA	NA	NA	NA	NA	NA	NA	NA	NA	NA	NA	NS	NS
Naphthalene	µg/l	NA	NA	NA	NA	NA	NA	NA	NA	NA	NA	NA	NA	NA	NA	NA	FP / [160 "Q"]	100	10
Dissolved Metals																			
Lead	µg/l	NA	NA	NA	NA	NA	NA	NA	NA	NA	NA	NA	NA	NA	NA	NA	NA	15	1.5

Notes:

- µg/l = micrograms per liter (equivalent to parts per billion, ppb)
- NR 140 ES = Wisconsin Administrative Code, Chapter NR 140 Enforcement Standard
- NR 140 PAL = Wisconsin Administrative Code, Chapter NR 140 Preventive Action Limit
- FP = Free Product in well - no sample collected
- Laboratory flags:
 - "L" = Concentration flagged by laboratory as common lab solvent and contaminant
 - "J" = Concentration reported between Method Detection Limit and Limit of Quantitation
 - "Q" = Unquantitated hydrocarbons present in the sample outside of the reported carbon range (lab indicated these are late end petroleum hydrocarbon peaks)
- Exceedances:
 - [] = Concentration exceeds NR 140 ES
 - () = Concentration exceeds NR 140 PAL
- Trip blank results:
 - 12/19/01 - All PVOCs reported below laboratory detection limits
 - 3/17/03 - All PVOCs reported below laboratory detection limits
 - 12/30/03 - All PVOCs reported below laboratory detection limits
 - 4/13/06 - All PVOCs reported below laboratory detection limits
 - 2/25/09 & 2/26/09 - All PVOCs reported below laboratory detection limits
 - 3/21/11 - All PVOCs reported below laboratory detection limits
 - 8/4/11 - All PVOCs reported below laboratory detection limits
 - 11/4/11 - All PVOCs reported below laboratory detection limits
 - 6/7/12 - All PVOCs reported below laboratory detection limits
- Equipment blank results:
 - 12/19/01 - All PVOCs reported below laboratory detection limits, except for toluene reported at 0.22 µg/l in 1 blank (2 equipment blanks used this event)
 - 3/17/03 - All PVOCs reported below laboratory detection limits
 - 12/30/03 - Not used, as new disposable bailers used at each well to collect groundwater samples
- 4/13/06 - All PVOCs reported below laboratory detection limits, except benzene (1.3 µg/L) and toluene (0.62 µg/L). Benzene was not detected at low levels in any samples, but toluene was detected at low levels in well MW-15
 - 2/25/09 & 2/26/09 - All PVOCs reported below laboratory detection limits
 - 3/21/11 - All PVOCs reported below laboratory detection limits
 - 8/4/11 - All PVOCs reported below laboratory detection limits, except toluene (0.47 "J" µg/L). Toluene was not detected at this low level in any samples.
 - 11/4/11 - All PVOCs reported below laboratory detection limits
 - 6/7/12 - All PVOCs reported below laboratory detection limits

Table 3
Groundwater Quality Results
Jacobus Bulk Plant / Retail Station (Former) - 111 E. Decorah Road, West Bend, Wisconsin
Project Reference #6662

Sample Location:	RW-5					RW-6						RW-7					RW-8	NR 140	NR 140		
	Sample Date:	4/27/93	9/29/93	1/20/94	3/23/94	6/9/94	7/28/93	9/29/93	12/30/93	3/23/94	6/9/94	4/10/96	7/28/93	9/29/93	12/30/93	3/23/94	6/9/94	2/26/09	2/26/09	ES	PAL
PVOCs	Units																				
Benzene	µg/l	[2,400]	[12,000]	[6,000]	[1,400]	[1,900]	[1,700]	[170]	[5,000]	[5,400]	[6,200]	[3,830]	[1,200]	[1,500]	<100	<100	[170]	<1.0	[300]	5	0.5
Ethylbenzene	µg/l	(470)	[2,600]	[1,300]	(380)	(560)	(540)	(250)	[820]	(630)	[1,200]	[969]	[750]	[1,900]	<100	<100	76	82	[2,700]	700	140
Methyl tert Butyl Ether	µg/l	[150]	<50	<200	(35)	<100	<100	<10	<200	(38)	<500	ND	<10	<25	<100	<100	<20	<0.92	<18	60	12
Toluene	µg/l	[6,600]	[46,000]	[18,000]	[3,300]	[5,700]	[6,000]	[2,500]	[10,000]	[11,000]	[17,000]	[11,900]	[10,000]	[18,000]	(460)	13	[910]	4.3	[6,500]	800	160
1,2,4-Trimethylbenzene	µg/l	480	2,000	900	430	440	710	330	1,200	820	940	1,400	600	1,500	<100	3	92	410	2,100	NS	NS
1,3,5-Trimethylbenzene	µg/l	170	600	<200	47	<100	240	100	350	99	<500	336	160	420	<100	ND	<20	2.0 "J"	600	NS	NS
Total Trimethylbenzene	µg/l	[650]	[2,600]	[900]	(477)	(440)	[950]	(430)	[1,550]	[919]	[940]	[1,736]	[760]	[1,920]	<200	3	92	(412)	[2,700]	480	96
Total Xylenes	µg/l	[2,740]	[20,000]	[8,500]	[3,030]	[3,060]	[4,100]	[2,980]	[6,000]	[6,900]	[9,500]	[7,520]	[4,800]	[13,700]	(440)	27	(780)	59	[15,000]	2,000	400
Detected VOCs																					
n-Butylbenzene	µg/l	NA	NA	NA	NA	NA	NA	NA	NA	NA	NA	NA	NA	NA	NA	NA	NA	NA	NA	6	0.6
Chloroform	µg/l	NA	NA	NA	NA	NA	NA	NA	NA	NA	NA	NA	NA	NA	NA	NA	NA	NA	NA	6	0.6
Chloromethane	µg/l	NA	NA	NA	NA	NA	NA	NA	NA	NA	NA	NA	NA	NA	NA	NA	NA	NA	NA	30	3
Isopropylbenzene	µg/l	NA	NA	NA	NA	NA	NA	NA	NA	NA	NA	NA	NA	NA	NA	NA	NA	NA	NA	NS	NS
Methylene Chloride	µg/l	NA	NA	NA	NA	NA	NA	NA	NA	NA	NA	NA	NA	NA	NA	NA	NA	NA	NA	5	0.5
n-Propylbenzene	µg/l	NA	NA	NA	NA	NA	NA	NA	NA	NA	NA	NA	NA	NA	NA	NA	NA	NA	NA	NS	NS
Naphthalene	µg/l	NA	NA	NA	NA	NA	NA	NA	NA	NA	NA	NA	NA	NA	NA	NA	NA	(87)	[570]	100	10
Dissolved Metals																					
Lead	µg/l	NA	NA	NA	NA	NA	NA	NA	NA	NA	NA	NA	NA	NA	NA	NA	NA	NA	NA	15	1.5

Notes:

- µg/l = micrograms per liter (equivalent to parts per billion, ppb)
- NR 140 ES = Wisconsin Administrative Code, Chapter NR 140 Enforcement Standard
- NR 140 PAL = Wisconsin Administrative Code, Chapter NR 140 Preventive Action Limit
- FP = Free Product in well - no sample collected
- Laboratory flags:
 - "L" = Concentration flagged by laboratory as common lab solvent and contaminant
 - "J" = Concentration reported between Method Detection Limit and Limit of Quantitation
 - "Q" = Unquantitated hydrocarbons present in the sample outside of the reported carbon range (lab indicated these are late end petroleum hydrocarbon peaks)
- Exceedances:
 - [] = Concentration exceeds NR 140 ES
 - () = Concentration exceeds NR 140 PAL
- Trip blank results:
 - 12/19/01 - All PVOCs reported below laboratory detection limits
 - 3/17/03 - All PVOCs reported below laboratory detection limits
 - 12/30/03 - All PVOCs reported below laboratory detection limits
 - 4/13/06 - All PVOCs reported below laboratory detection limits
 - 2/25/09 & 2/26/09 - All PVOCs reported below laboratory detection limits
 - 3/21/11 - All PVOCs reported below laboratory detection limits
 - 8/4/11 - All PVOCs reported below laboratory detection limits
 - 11/4/11 - All PVOCs reported below laboratory detection limits
 - 6/7/12 - All PVOCs reported below laboratory detection limits
- Equipment blank results:
 - 12/19/01 - All PVOCs reported below laboratory detection limits, except for toluene reported at 0.22 µg/l in 1 blank (2 equipment blanks used this event)
 - 3/17/03 - All PVOCs reported below laboratory detection limits
 - 12/30/03 - Not used, as new disposable bailers used at each well to collect groundwater samples
 - 4/13/06 - All PVOCs reported below laboratory detection limits, except benzene (1.3 µg/L) and toluene (0.62 µg/L). Benzene was not detected at low levels in any samples, but toluene was detected at low levels in well MW-11
 - 2/25/09 & 2/26/09 - All PVOCs reported below laboratory detection limits
 - 3/21/11 - All PVOCs reported below laboratory detection limits
 - 8/4/11 - All PVOCs reported below laboratory detection limits, except toluene (0.47 "J" µg/L). Toluene was not detected at this low of level in any samples.
 - 11/4/11 - All PVOCs reported below laboratory detection limits
 - 6/7/12 - All PVOCs reported below laboratory detection limits

Table 2 Static Groundwater Elevations Jacobus Bulk Plant / Retail Station (Former) - 111 E. Decorah Road, West Bend, Wisconsin Project Reference #6662															
Monitoring Well	Top of Casing Elevation (ft MSL)	Ground Surface Elevation (ft MSL)	Depth to Product (feet TOC)	Depth to Water (feet TOC)	Depth to Water (feet bgs)	Product Thickness (ft)	Groundwater Elevation (ft MSL)	Well Screen Interval (ft MSL)	Free Product Removal Comments	Date					
MW-1	924.32	922.2	---	18.00	15.88	---	906.32			12/17/1991					
			17.27	17.72	15.60	0.45	906.98			11/12/1992					
			18.91	18.95	16.83	0.04	905.40			1/28/1993					
			21.45	21.46	19.34	0.01	902.87			3/24/1993					
			---	20.89	18.77	---	903.43			5/3/1993					
			17.16	17.33	15.21	0.17	907.13			7/9/1993					
			---	21.75	19.63	---	902.57			7/28/1993					
			---	20.84	18.72	---	903.48			9/14/1993					
			---	20.92	18.80	---	903.40			9/20/1993					
			---	20.75	18.63	---	903.57			10/5/1993					
			MW-1 (new)	924.30	922.4	19.19	19.20			17.30	0.01	905.11	914.1 - 899.1 (8.1 - 23.1 ft bgs)		12/30/1993
						---	20.32			18.42	---	903.98			3/4/1994
						20.34	20.36			18.46	0.02	903.96			3/24/1994
---	20.16	18.26				---	904.14	6/9/1994							
---	19.48	17.58				---	904.82	9/14/1994							
---	19.92	18.02				---	904.38	12/8/1994							
---	19.24	17.34				---	905.06	5/16/1995							
---	19.48	17.58				---	904.82	8/29/1995							
---	21.02	19.12				---	903.28	1/16/1996							
---	19.71	17.81				---	904.59	2/6/1996							
---	19.40	17.50				---	904.90	5/13/1996							
---	17.42	15.52				---	906.88	6/21/1996							
---	18.30	16.40				---	906.00	8/8/1996							
---	18.92	17.02				---	905.38	10/24/1996							
---	19.28	17.38				---	905.02	11/13/1996							
---	19.22	17.32				---	905.08	2/5/1997							
---	18.69	16.79				---	905.61	6/18/1997							
---	19.33	17.43				---	904.97	11/19/1998							
---	17.69	15.79				---	906.61	5/20/1999							
---	17.84	15.94				---	906.46	8/26/1999							
---	18.75	16.85	---	905.55	11/10/1999										
---	18.80	16.90	---	905.50	12/19/2001										
---	19.69	17.79	---	904.61	3/17/2003										
---	19.74	17.84	---	904.56	12/30/2003										
---	18.45	16.55	---	905.85	4/13/2006										
---	17.88	15.98	---	906.42	2/25/2009										
---	17.69	15.79	---	906.61	3/21/2011										
---	16.51	14.61	---	907.79	Vac truck: GW & FP removed****	5/11/2011									
---	17.35	15.45	---	906.95	Vac truck: GW & FP removed****	6/14/2011									
---	17.75	15.85	---	906.55	Vac truck: GW & FP removed*****	7/14/2011									
---	17.86	15.96	---	906.44		8/4/2011									
---	17.85	15.95	---	906.45	Vac truck: GW & FP removed*****	8/17/2011									
---	18.30	16.40	---	906.00	Vac truck: GW & FP removed*****	9/19/2011									
---	18.13	16.23	---	906.17	Vac truck: GW & FP	10/20/2011									
---	18.37	16.47	---	905.93		11/4/2011									
---	17.87	15.97	---	906.43		6/7/2012									

Table 2 Static Groundwater Elevations Jacobus Bulk Plant / Retail Station (Former) - 111 E. Decorah Road, West Bend, Wisconsin Project Reference #6662										
Monitoring Well	Top of Casing Elevation (ft MSL)	Ground Surface Elevation (ft MSL)	Depth to Product (feet TOC)	Depth to Water (feet TOC)	Depth to Water (feet bgs)	Product Thickness (ft)	Groundwater Elevation (ft MSL)	Well Screen Interval (ft MSL)	Free Product Removal Comments	Date
MW-2	923.48	921.7	---	17.85	16.07	---	905.63	908.2 - 898.2 (13.5 - 23.5 ft bgs)		12/17/1991
			---	17.80	16.02	---	905.68			11/12/1992
			---	18.11	16.33	---	905.37			1/28/1993
			---	18.56	16.78	---	904.92			3/24/1993
			---	16.90	15.12	---	906.58			5/3/1993
			---	16.56	14.78	---	906.92			7/9/1993
			---	17.24	15.46	---	906.24			7/28/1993
			---	17.40	15.62	---	906.08			9/14/1993
			---	17.18	15.40	---	906.30			9/20/1993
			---	17.10	15.32	---	906.38			9/29/1993
			---	17.66	15.88	---	905.82			10/5/1993
			---	18.14	16.36	---	905.34			12/30/1993
			---	18.62	16.84	---	904.86			3/4/1994
			---	18.06	16.28	---	905.42			3/24/1994
			---	18.36	16.58	---	905.12			6/9/1994
			---	18.81	17.03	---	904.67			9/14/1994
			---	19.13	17.35	---	904.35			12/8/1994
			---	18.65	16.87	---	904.83			5/16/1995
			---	18.75	16.97	---	904.73			8/29/1995
			---	19.40	17.62	---	904.08			1/16/1996
			---	19.17	17.39	---	904.31			2/6/1996
			---	18.64	16.86	---	904.84			5/13/1996
			---	17.04	15.26	---	906.44			6/21/1996
			---	17.80	16.02	---	905.68			8/8/1996
			---	18.15	16.37	---	905.33			10/24/1996
			---	18.42	16.64	---	905.06			11/13/1996
			---	18.54	16.76	---	904.94			2/5/1997
			---	18.06	16.28	---	905.42			6/18/1997
			---	18.58	16.80	---	904.90			11/19/1998
			---	17.22	15.44	---	906.26			5/20/1999
			---	17.34	15.56	---	906.14			8/26/1999
			---	18.09	16.31	---	905.39			11/10/1999
			---	18.16	16.38	---	905.32			12/19/2001
			---	19.05	17.27	---	904.43			3/17/2003
			---	19.21	17.43	---	904.27			12/30/2003
			---	18.16	16.38	---	905.32			4/13/2006
			---	17.39	15.61	---	906.09			2/25/2009
			---	17.13	15.35	---	906.35			3/21/2011
			---	NM	---	---	---			5/11/2011
			---	16.84	15.06	---	906.64			6/14/2011
---	17.15	15.37	---	906.33	7/14/2011					
---	17.23	15.45	---	906.25	8/4/2011					
---	17.18	15.40	---	906.30	8/17/2011					
---	17.65	15.87	---	905.83	9/19/2011					
---	17.53	15.75	---	905.95	10/20/2011					
---	17.73	15.95	---	905.75	11/4/2011					
---	17.27	15.49	---	906.21	6/7/2012					

Table 2 Static Groundwater Elevations Jacobus Bulk Plant / Retail Station (Former) - 111 E. Decorah Road, West Bend, Wisconsin Project Reference #6662										
Monitoring Well	Top of Casing Elevation (ft MSL)	Ground Surface Elevation (ft MSL)	Depth to Product (feet TOC)	Depth to Water (feet TOC)	Depth to Water (feet bgs)	Product Thickness (ft)	Groundwater Elevation (ft MSL)	Well Screen Interval (ft MSL)	Free Product Removal Comments	Date
MW-3	925.11	923.3	19.89	20.10	18.29	0.21	905.19	911.8 - 910.3 (11.5 - 22 ft bgs)		12/17/1991
			20.14	20.94	19.13	0.80	904.85			2/6/1992
			20.32	20.39	18.58	0.07	904.78			2/7/1992
			20.50	20.75	18.94	0.25	904.57			2/26/1992
			20.31	20.41	18.60	0.10	904.79			3/19/1992
			---	19.64	17.83	---	905.47			11/12/1992
			---	20.28	18.47	---	904.83			1/28/1993
			21.56	21.71	19.90	0.15	903.53			3/24/1993
			---	19.00	17.19	---	906.11			5/3/1993
			18.69	19.51	17.70	0.82	906.30			7/9/1993
			---	20.55	18.74	---	904.56			7/28/1993
			---	20.18	18.37	---	904.93			9/14/1993
			20.68	20.69	18.88	0.01	904.43			9/20/1993
			20.30	20.42	18.61	0.12	904.79			10/5/1993
			20.67	20.85	19.04	0.18	904.41			12/30/1993
			21.55	22.85	21.04	1.30	903.37			3/24/1994
			21.08	21.42	19.61	0.34	903.98			6/9/1994
			20.58	20.85	19.04	0.27	904.49			8/8/1994
			21.13	21.47	19.66	0.34	903.93			9/14/1994
			21.55	22.75	20.94	1.20	903.38			12/8/1994
			21.45	21.63	19.82	0.18	903.63			1/31/1995
			21.92	22.05	20.24	0.13	903.17			3/14/1995
			---	21.59	19.78	---	903.52			5/16/1995
			---	21.26	19.54	---	903.76			8/29/1995
			---	22.22	20.50	---	902.80			1/16/1996
			---	21.16	19.44	---	903.86			2/6/1996
			---	20.76	19.04	---	904.26			5/13/1996
			---	21.36	19.64	---	903.66			6/21/1996
			19.74	19.76	18.04	0.02	905.28			8/8/1996
			---	20.54	18.82	---	904.48			10/24/1996
			---	21.01	19.29	---	904.01			11/13/1996
			---	20.50	18.78	---	904.52			2/5/1997
			19.97	20.61	18.89	0.64	904.95			6/18/1997
	20.67	20.96	19.24	0.29	904.31	11/19/1998				
	19.51	20.05	18.33	0.54	905.43	5/20/1999				
	19.41	19.93	18.21	0.52	905.53	6/3/1999				
	19.15	19.70	17.98	0.55	905.79	8/26/1999				
	20.02	20.41	18.69	0.39	904.94	11/10/1999				
	20.22	20.56	18.84	0.34	904.75	12/19/2001				
	21.09	21.81	20.09	0.72	903.82	3/17/2003				
	21.09	21.77	20.05	0.68	903.83	12/30/2003				
	20.34	20.37	18.65	0.03	904.68	4/13/2006				
	19.68	19.72	18.00	0.04	905.33	2/25/2009				
---	20.00	18.19	---	905.02	3/21/2011					
18.43	18.44	16.72	0.01	906.59	Vac truck: GW & FP removed**** 5/11/2011					
---	18.78	16.97	---	906.24	Vac truck: GW & FP removed***** 6/14/2011					
---	19.07	17.26	---	905.95	Vac truck: GW & FP removed***** 7/14/2011					
---	19.20	17.39	---	905.82	8/4/2011					
---	19.28	17.47	---	905.74	Vac truck: GW & FP removed***** 8/17/2011					
19.60	19.62	17.90	0.02	905.42	Vac truck: GW & FP removed***** 9/19/2011					
19.52	19.53	17.81	0.01	905.50	Vac truck: GW & FP 10/20/2011					
19.72	19.73	18.01	0.01	905.30	11/4/2011					
---	19.27	17.46	---	905.75	6/7/2012					

Table 2
Static Groundwater Elevations
Jacobus Bulk Plant / Retail Station (Former) - 111 E. Decorah Road, West Bend, Wisconsin
Project Reference #6662

Monitoring Well	Top of Casing Elevation (ft MSL)	Ground Surface Elevation (ft MSL)	Depth to Product (feet TOC)	Depth to Water (feet TOC)	Depth to Water (feet bgs)	Product Thickness (ft)	Groundwater Elevation (ft MSL)	Well Screen Interval (ft MSL)	Free Product Removal Comments	Date
MW-4	921.49	922.2	14.74	16.94	17.69	2.20	906.42	910.7 - 900.2 (11.5 - 22 ft bgs)		12/17/1991
			14.88	18.99	19.74	4.11	905.99		2/6/1992	
			15.63	16.51	17.26	0.88	905.73		2/7/1992	
			16.00	17.06	17.81	1.06	905.33		2/26/1992	
			15.86	16.72	17.47	0.86	905.50		3/19/1992	
			15.09	19.61	20.36	4.52	905.72		1/28/1993	
			13.74	15.78	16.53	2.04	907.44		5/3/1993	
			13.51	15.58	16.33	2.07	907.67		7/9/1993	
			14.26	16.79	17.54	2.53	906.85		7/28/1993	
			14.45	17.25	18.00	2.80	906.62		9/14/1993	
			13.75	15.95	16.70	2.20	907.41		9/20/1993	
			15.35	17.10	17.85	1.75	905.88		10/5/1993	
			15.10	15.45	16.20	0.35	906.34		11/4/1993	
			15.45	16.31	17.06	0.86	905.91		11/30/1993	
			15.90	16.91	17.66	1.01	905.44		12/30/1993	
			16.62	17.96	18.71	1.34	904.67		1/26/1994	
			15.20	15.35	16.10	0.15	906.27		2/23/1994	
			16.38	16.98	17.73	0.60	905.02		3/4/1994	
			16.84	17.75	18.50	0.91	904.51		3/24/1994	
			16.60	16.85	17.60	0.25	904.85		6/9/1994	
			16.56	16.70	17.45	0.14	904.91		9/14/1994	
			---	17.09	17.84	---	904.40		12/8/1994	
			16.89	16.97	17.72	0.08	904.59		1/31/1995	
			17.25	17.80	18.55	0.55	904.16		3/14/1995	
			16.47	16.50	17.25	0.03	905.02		5/16/1995	
			16.94	16.98	17.73	0.04	904.54		8/29/1995	
			17.40	17.55	18.30	0.15	904.07		1/16/1996	
			16.97	17.17	17.92	0.20	904.49		2/6/1996	
			16.50	16.60	17.35	0.10	904.98		5/13/1996	
			---	15.54	16.29	---	905.95		6/21/1996	
			15.22	15.30	16.05	0.08	906.26		8/8/1996	
			---	18.70	19.45	---	902.79		10/24/1996	
			---	16.92	17.67	---	904.57		11/13/1996	
			---	16.33	17.08	---	905.16		2/5/1997	
			---	15.64	16.39	---	905.85		6/18/1997	
			---	16.44	17.19	---	905.05		11/20/1998	
			---	14.88	15.63	---	906.61		5/20/1999	
			16.14	16.15	16.90	0.01	905.35		11/10/1999	
			15.90	16.07	16.82	0.17	905.56		12/19/2001	
			16.86	17.08	17.83	0.22	904.60		3/17/2003	FP removed*
			16.85	17.00	17.75	0.15	904.62		12/30/2003	FP removed**
			15.58	16.18	16.93	0.60	905.82		4/13/2006	FP removed***
15.19	15.56	16.31	0.37	906.24	2/25/2009	<0.25 gallon FP removed				
15.19	15.39	16.14	0.20	906.27	3/21/2011	0.25 gallon FP removed				
13.66	14.27	15.02	0.61	907.74	5/11/2011	Vac truck: GW & FP removed****				
14.34	14.43	15.18	0.09	907.14	6/14/2011	Vac truck: GW & FP removed*****				
14.81	14.87	15.62	0.06	906.67	7/14/2011	Vac truck: GW & FP removed*****				
15.00	15.10	15.85	0.10	906.48	8/4/2011	<0.25 gallon FP removed				
15.00	15.08	15.83	0.08	906.48	8/17/2011	Vac truck: GW & FP removed*****				
15.44	15.49	16.24	0.05	906.04	9/19/2011	Vac truck: GW & FP removed*****				
15.26	15.30	16.05	0.04	906.22	10/20/2011	Vac truck: GW & FP				
15.50	15.53	16.28	0.03	905.99	11/4/2011	<0.25 gallon FP removed				
15.02	15.05	15.80	0.03	906.47	6/7/2012	<0.25 gallon FP removed				

Table 2
Static Groundwater Elevations
Jacobus Bulk Plant / Retail Station (Former) - 111 E. Decorah Road, West Bend, Wisconsin
Project Reference #6662

Monitoring Well	Top of Casing Elevation (ft MSL)	Ground Surface Elevation (ft MSL)	Depth to Product (feet TOC)	Depth to Water (feet TOC)	Depth to Water (feet bgs)	Product Thickness (ft)	Groundwater Elevation (ft MSL)	Well Screen Interval (ft MSL)	Free Product Removal Comments	Date
MW-5	922.42	922.8	15.76	17.88	18.22	2.12	906.34	911.3 - 900.8 (11.5 - 22 ft bgs)		12/17/1991
			15.43	21.06	21.40	5.63	906.15		2/6/1992	
			16.49	16.82	17.16	0.33	905.88		2/7/1992	
			16.26	19.53	19.87	3.27	905.67		2/26/1992	
			15.71	20.46	20.80	4.75	906.00		3/19/1992	
			15.38	20.26	20.60	4.88	906.31		11/12/1992	
			15.49	20.99	21.33	5.50	906.11		1/28/1993	
			16.19	21.03	21.37	4.84	905.50		3/24/1993	
			12.98	17.40	17.74	4.42	908.78		7/9/1993	
			13.65	18.01	18.35	4.36	908.12		7/28/1993	
			12.55	16.65	16.99	4.10	909.26		9/20/1993	
			14.75	18.45	18.79	3.70	907.12		10/5/1993	
			15.01	18.21	18.55	3.20	906.93		11/4/1993	
			15.59	18.79	19.13	3.20	906.35		11/30/1993	
			16.23	18.21	18.55	1.98	905.89		12/30/1993	
			16.60	19.75	20.09	3.15	905.35		1/26/1994	
			15.67	15.87	16.21	0.20	906.72		2/23/1994	
			17.13	17.50	17.84	0.37	905.23		3/4/1994	
			17.08	18.09	18.43	1.01	905.19		3/24/1994	
			15.64	18.50	18.84	2.86	906.35		6/9/1994	
			16.70	17.50	17.84	0.80	905.60		8/8/1994	
			17.10	18.05	18.39	0.95	905.18		9/14/1994	
			17.79	18.35	18.69	0.56	904.55		12/8/1994	
			17.60	18.20	18.54	0.60	904.73		1/31/1995	
			18.25	18.45	18.79	0.20	904.14		3/14/1995	
			17.25	17.80	18.14	0.55	905.09		5/16/1995	
			18.80	19.54	19.88	0.74	903.51		8/29/1995	
			17.85	17.98	18.32	0.13	904.55		2/6/1996	
			17.08	17.40	17.74	0.32	905.29		5/13/1996	
			16.45	17.79	18.13	1.34	905.77		6/21/1996	
			15.68	16.90	17.24	1.22	906.56		8/8/1996	
			---	18.28	18.62	---	904.14		10/24/1996	
			---	19.01	19.35	---	903.41		11/13/1996	
			16.84	21.06	21.40	4.22	904.95		2/5/1997	
			16.57	19.97	20.31	3.40	905.34		11/19/1998	
			15.76	16.76	17.10	1.00	906.51		5/20/1999	
			15.58	16.69	17.03	1.11	906.67		6/3/1999	
			17.20	17.64	17.98	0.44	905.15		11/10/1999	
			16.41	18.43	18.77	2.02	905.71		12/19/2001	
			17.07	21.08	21.42	4.01	904.75		3/17/2003	
			17.70	18.30	18.64	0.60	904.63		12/30/2003	
16.42	17.43	17.77	1.01	905.85	4/13/2006					
16.10	16.62	16.96	0.52	906.24	0.5 gallon FP removed					
16.31	16.52	16.86	0.21	906.08	0.25 gallon FP removed					
14.68	15.40	15.74	0.72	907.63	Vac truck: GW & FP removed****					
15.00	15.52	15.86	0.52	907.34	Vac truck: GW & FP removed*****					
15.38	15.83	16.17	0.45	906.97	Vac truck: GW & FP removed*****					
15.58	15.95	16.29	0.37	906.78	<0.25 gallon FP removed					
15.63	16.04	16.38	0.41	906.73	Vac truck: GW & FP removed*****					
16.06	16.15	16.49	0.09	906.35	Vac truck: GW & FP removed*****					
15.82	16.30	16.64	0.48	906.53	Vac truck: GW & FP					
16.08	16.43	16.77	0.35	906.29	<0.25 gallon FP removed					
15.78	16.02	16.36	0.24	906.60	<0.25 gallon FP removed					

Table 2 Static Groundwater Elevations Jacobus Bulk Plant / Retail Station (Former) - 111 E. Decorah Road, West Bend, Wisconsin Project Reference #6662										
Monitoring Well	Top of Casing Elevation (ft MSL)	Ground Surface Elevation (ft MSL)	Depth to Product (feet TOC)	Depth to Water (feet TOC)	Depth to Water (feet bgs)	Product Thickness (ft)	Groundwater Elevation (ft MSL)	Well Screen Interval (ft MSL)	Free Product Removal Comments	Date
MW-6	922.17	922.9	---	15.28	16.05	---	906.89	911.4 - 900.9 (11.5 - 22 ft bgs)		12/17/1991
			---	15.44	16.21	---	906.73		11/12/1992	
			12.85	15.25	16.02	2.40	908.96		7/9/1993	
			13.37	15.81	16.58	2.44	908.43		7/28/1993	
			12.97	16.20	16.97	3.23	908.72		9/14/1993	
			13.25	15.35	16.12	2.10	908.61		9/20/1993	
			14.02	16.10	16.87	2.08	907.84		10/5/1993	
			14.57	16.11	16.88	1.54	907.37		11/4/1993	
			15.07	16.16	16.93	1.09	906.94		11/30/1993	
			15.65	16.55	17.32	0.90	906.39		12/30/1993	
			15.59	16.04	16.81	0.45	906.51		2/23/1994	
			17.32	17.34	18.11	0.02	904.85		3/4/1994	
			15.84	16.10	16.87	0.26	906.29		3/24/1994	
			15.95	16.10	16.87	0.15	906.20		6/9/1994	
			16.15	16.20	16.97	0.05	906.01		8/8/1994	
			16.46	16.81	17.58	0.35	905.66		9/14/1994	
			16.97	17.84	18.61	0.87	905.07		12/8/1994	
			16.84	16.95	17.72	0.11	905.31		1/31/1995	
			17.40	17.95	18.72	0.55	904.69		3/14/1995	
			---	16.38	17.15	---	905.79		5/16/1995	
			---	16.68	17.45	---	905.49		8/29/1995	
			---	17.14	17.91	---	905.03		1/16/1996	
			17.09	17.18	17.95	0.09	905.07		2/6/1996	
			---	16.20	16.97	---	905.97		5/13/1996	
			---	14.78	15.55	---	907.39		6/21/1996	
			14.92	14.98	15.75	0.06	907.24		8/8/1996	
			---	15.90	16.67	---	906.27		10/24/1996	
			---	16.00	16.77	---	906.17		11/13/1996	
			---	16.36	17.13	---	905.81		2/5/1997	
			---	15.39	16.16	---	906.78		6/18/1997	
			---	16.46	17.23	---	905.71		11/20/1998	
			---	14.69	15.46	---	907.48		5/20/1999	
			15.76	15.79	16.56	0.03	906.41		11/10/1999	
15.91	15.96	16.73	0.05	906.25	12/19/2001					
16.93	16.94	17.71	0.01	905.24	3/17/2003					
16.97	17.10	17.87	0.13	905.18	12/30/2003					
15.35	15.37	16.14	0.02	906.82	4/13/2006					
15.15	15.33	16.10	0.18	906.99	2/25/2009					
---	14.99	15.76	---	907.18	3/21/2011					
13.50	13.52	14.29	0.02	908.67	5/11/2011					
14.22	14.24	15.01	0.02	907.95	6/14/2011					
14.59	14.63	15.40	0.04	907.57	7/14/2011					
14.75	14.83	15.60	0.08	907.41	8/4/2011					
14.77	14.83	15.60	0.06	907.39	8/17/2011					
15.27	15.31	16.08	0.04	906.89	9/19/2011					
Monitoring well MW-6 abandoned by removal during UST removal work on 10/6/11										10/20/2011
---	---	---	---	---	---	---	---	---	---	11/4/2011
MW-6R	922.20	922.5	---	15.17	15.50	---	907.03	911.8 - 901.8 (10.7 - 20.7 ft bgs)		6/7/2012

Table 2 Static Groundwater Elevations Jacobus Bulk Plant / Retail Station (Former) - 111 E. Decorah Road, West Bend, Wisconsin Project Reference #6662															
Monitoring Well	Top of Casing Elevation (ft MSL)	Ground Surface Elevation (ft MSL)	Depth to Product (feet TOC)	Depth to Water (feet TOC)	Depth to Water (feet bgs)	Product Thickness (ft)	Groundwater Elevation (ft MSL)	Well Screen Interval (ft MSL)	Free Product Removal Comments	Date					
MW-7	928.56	926.7	---	21.25	19.39	---	907.31			12/17/2001					
			---	21.68	19.82	---	906.88			11/12/1992					
			---	21.66	19.80	---	906.90			1/28/1993					
			---	22.06	20.20	---	906.50			3/24/1993					
			---	19.78	17.92	---	908.78			7/9/1993					
			---	19.96	18.10	---	908.60			7/28/1993					
			---	20.44	18.58	---	908.12			9/14/1993					
			---	20.26	18.40	---	908.30			9/20/1993					
			---	20.27	18.41	---	908.29			9/29/1993					
			---	20.50	18.64	---	908.06			10/5/1993					
			---	21.78	20.08	---	906.92			12/30/1993					
			---	22.16	20.46	---	906.54			1/20/1994					
			---	22.38	20.68	---	906.32			3/4/1994					
			---	22.03	20.33	---	906.67			3/24/1994					
MW-7 (new)	928.70	927.0	---	21.78	20.08	---	906.92	912.7 - 902.2 (14 - 24.5 ft bgs)		12/30/1993					
			---	22.16	20.46	---	906.54			1/20/1994					
			---	22.38	20.68	---	906.32			3/4/1994					
			---	22.03	20.33	---	906.67			3/24/1994					
			---	22.15	20.45	---	906.55			6/9/1994					
			---	22.64	20.94	---	906.06			9/14/1994					
			---	23.30	21.60	---	905.40			12/8/1994					
			---	22.59	20.89	---	906.11			5/16/1995					
			---	22.96	21.26	---	905.74			8/29/1995					
			---	23.37	21.67	---	905.33			2/6/1996					
			---	22.44	20.74	---	906.26			5/13/1996					
			---	18.90	17.20	---	909.80			6/21/1996					
			---	20.10	18.40	---	908.60			10/24/1996					
			---	22.02	20.32	---	906.68			11/13/1996					
			---	22.46	20.76	---	906.24			2/5/1997					
			---	19.70	18.00	---	909.00			6/18/1997					
			---	20.60	18.90	---	908.10			11/19/1998					
			---	20.89	19.19	---	907.81			5/20/1999					
			---	21.79	20.09	---	906.91			11/10/1999					
			---	22.05	20.35	---	906.65			12/19/2001					
			---	23.37	21.67	---	905.33			3/17/2003					
			---	23.30	21.60	---	905.40			12/30/2003					
						Bentonite obstruction at 6.8 feet TOC)									4/13/2006
						Bentonite obstruction at 6.8 feet TOC)									2/25/2009
						---	21.55			19.85	---	907.15			3/21/2011
						---	NM			---	---				5/11/2011
						---	20.35			18.65	---	908.35			6/14/2011
						---	20.77			19.07	---	907.93			7/14/2011
			---	20.85	19.15	---	907.85			8/4/2011					
			---	20.90	19.20	---	907.80			8/17/2011					
			---	21.36	19.66	---	907.34			9/19/2011					
			---	21.08	19.38	---	907.62			10/20/2011					
			---	21.45	19.75	---	907.25			11/4/2011					
			---	20.85	19.15	---	907.85			6/7/2012					

<p align="center">Table 2 Static Groundwater Elevations Jacobus Bulk Plant / Retail Station (Former) - 111 E. Decorah Road, West Bend, Wisconsin Project Reference #6662</p>										
Monitoring Well	Top of Casing Elevation (ft MSL)	Ground Surface Elevation (ft MSL)	Depth to Product (feet TOC)	Depth to Water (feet TOC)	Depth to Water (feet bgs)	Product Thickness (ft)	Groundwater Elevation (ft MSL)	Well Screen Interval (ft MSL)	Free Product Removal Comments	Date
MW-8	920.35	920.9	---	15.80	16.36	---	904.55	906.9 - 896.9 (14 - 24 ft bgs)		1/20/1994
			---	15.52	16.08	---	904.83		2/21/1994	
			---	15.42	15.98	---	904.93		3/4/1994	
			---	15.42	15.98	---	904.93		3/24/1994	
			---	15.55	16.11	---	904.80		6/9/1994	
			---	15.92	16.48	---	904.43		9/14/1994	
			---	16.40	16.96	---	903.95		12/8/1994	
			---	15.72	16.28	---	904.63		5/16/1995	
			---	15.75	16.31	---	904.60		8/29/1995	
			---	16.44	17.00	---	903.91		1/16/1996	
			---	15.68	16.24	---	904.67		5/13/1996	
			---	14.56	15.12	---	905.79		6/21/1996	
			---	14.92	15.48	---	905.43		8/8/1996	
			---	15.44	16.00	---	904.91		10/24/1996	
			---	15.45	16.01	---	904.90		11/13/1996	
			---	15.82	16.38	---	904.53		2/5/1997	
			---	15.28	15.84	---	905.07		6/18/1997	
			---	15.86	16.42	---	904.49		11/19/1998	
			---	14.70	15.26	---	905.65		5/20/1999	
			---	14.79	15.35	---	905.56		8/26/1999	
			---	15.45	16.01	---	904.90		11/10/1999	
			---	15.49	16.05	---	904.86		12/19/2001	
			---	15.91	16.47	---	904.44		3/17/2003	
			---	16.18	16.74	---	904.17		12/30/2003	
			---	15.36	15.92	---	904.99		4/13/2006	
			---	15.02	15.58	---	905.33		2/25/2009	
			---	14.61	15.17	---	905.74		3/21/2011	
			---	NM	---	---	---		5/11/2011	
			---	14.58	15.14	---	905.77		6/14/2011	
			---	14.90	15.46	---	905.45		7/14/2011	
---	14.94	15.50	---	905.41	8/4/2011					
---	14.96	15.52	---	905.39	8/17/2011					
---	15.32	15.88	---	905.03	9/19/2011					
---	15.21	15.77	---	905.14	10/20/2011					
---	15.37	15.93	---	904.98	11/4/2011					
---	15.00	15.56	---	905.35	6/7/2012					

<p align="center">Table 2 Static Groundwater Elevations Jacobus Bulk Plant / Retail Station (Former) - 111 E. Decorah Road, West Bend, Wisconsin Project Reference #6662</p>													
Monitoring Well	Top of Casing Elevation (ft MSL)	Ground Surface Elevation (ft MSL)	Depth to Product (feet TOC)	Depth to Water (feet TOC)	Depth to Water (feet bgs)	Product Thickness (ft)	Groundwater Elevation (ft MSL)	Well Screen Interval (ft MSL)	Free Product Removal Comments	Date			
MW-9	920.46	920.9	---	16.85	17.30	---	903.61	906.9 - 896.9 (14 - 24 ft bgs)		1/20/1994			
			---	16.88	17.33	---	903.58		2/21/1994				
			---	15.76	16.21	---	904.70		3/4/1994				
			---	16.78	17.23	---	903.68		3/24/1994				
			---	16.83	17.28	---	903.63		6/9/1994				
			---	17.10	17.55	---	903.36		9/14/1994				
			---	17.44	17.89	---	903.02		12/8/1994				
			---	17.06	17.51	---	903.40		5/16/1995				
			---	17.04	17.49	---	903.42		8/29/1995				
			---	17.46	17.91	---	903.00		1/16/1996				
			---	17.94	18.39	---	902.52		5/13/1996				
			---	16.17	16.62	---	904.29		6/21/1996				
			---	16.00	16.45	---	904.46		8/8/1996				
			---	16.86	17.31	---	903.60		10/24/1996				
			---	16.98	17.43	---	903.48		11/13/1996				
			---	16.96	17.41	---	903.50		2/5/1997				
			---	16.50	16.95	---	903.96		6/18/1997				
			---	16.98	17.43	---	903.48		11/19/1998				
			---	16.19	16.64	---	904.27		5/20/1999				
			---	15.83	16.28	---	904.63		8/26/1999				
			---	16.50	16.95	---	903.96		11/10/1999				
			---	16.62	17.07	---	903.84		12/19/2001				
			---	17.26	17.71	---	903.20		3/17/2003				
			---	17.36	17.81	---	903.10		12/30/2003				
			---	16.73	17.18	---	903.73		4/13/2006				
			---	Could not locate well									2/25/2009
			---	16.21	16.66	---	904.25		3/21/2011				
			---	NM	---	---	---		5/11/2011				
			---	15.54	15.99	---	904.92		6/14/2011				
			---	15.81	16.26	---	904.65		7/14/2011				
			---	15.91	16.36	---	904.55		8/4/2011				
			---	16.00	16.45	---	904.46		8/17/2011				
			---	16.26	16.71	---	904.20		9/19/2011				
---	16.20	16.65	---	904.26	10/20/2011								
---	16.34	16.79	---	904.12	11/4/2011								
---	15.98	16.43	---	904.48	6/7/2012								

Table 2 Static Groundwater Elevations Jacobus Bulk Plant / Retail Station (Former) - 111 E. Decorah Road, West Bend, Wisconsin Project Reference #6662														
Monitoring Well	Top of Casing Elevation (ft MSL)	Ground Surface Elevation (ft MSL)	Depth to Product (feet TOC)	Depth to Water (feet TOC)	Depth to Water (feet bgs)	Product Thickness (ft)	Groundwater Elevation (ft MSL)	Well Screen Interval (ft MSL)	Free Product Removal Comments	Date				
MW-10	921.02	921.5	---	18.29	18.81	---	902.73	907.5 - 897.5 (14 - 24 ft bgs)		1/20/1994				
			---	18.42	18.94	---	902.60			2/21/1994				
			---	19.58	20.10	---	901.44			3/4/1994				
			---	18.20	18.72	---	902.82			3/24/1994				
			---	18.40	18.92	---	902.62			6/9/1994				
			---	18.60	19.12	---	902.42			9/14/1994				
			---	18.72	19.24	---	902.30			9/26/1994				
			---	19.10	19.62	---	901.92			12/8/1994				
			18.80	19.20	19.72	0.40	902.16			5/16/1995				
			19.20	19.84	20.36	0.64	901.72			8/29/1995				
			18.60	18.92	19.44	0.32	902.37			5/13/1996				
			---	18.08	18.60	---	902.94			6/21/1996				
			19.42	19.45	19.97	0.03	901.60			8/8/1996				
			---	19.99	20.51	---	901.03			11/13/1996				
			18.35	19.74	20.26	1.39	902.46			2/5/1997				
			---	18.10	18.62	---	902.92			6/18/1997				
			18.45	19.31	19.83	0.86	902.44			11/19/1998				
			17.87	17.88	18.40	0.01	903.15			5/20/1999				
			18.10	18.11	18.63	0.01	902.92			11/10/1999				
			---	18.28	18.80	---	902.74			12/19/2001				
			19.07	19.22	19.74	0.15	901.93			3/17/2003				
			Could not locate well										FP removed*	12/30/2003
			---				18.62			19.14	---	902.40		4/13/2006
			---				17.84			18.36	---	903.18		2/25/2009
			Mud obstruction at 2.4 feet TOC											3/21/2011
			Mud obstruction at 2.4 feet TOC											5/11/2011
			Mud obstruction at 2.4 feet TOC - cleared with vacuum truck											6/14/2011
			---				17.40			17.92	---	903.62	Vac truck: GW & FP removed*****	7/14/2011
			---				17.55			18.07	---	903.47		8/4/2011
			---				17.60			18.12	---	903.42	Vac truck: GW & FP removed*****	8/17/2011
			---				17.85			18.37	---	903.17	Vac truck: GW & FP removed*****	9/19/2011
			---				17.82			18.34	---	903.20	Vac truck: GW & FP	10/20/2011
---				17.96	18.48	---	903.06		11/4/2011					
---				17.65	18.17	---	903.37		6/7/2012					

Table 2 Static Groundwater Elevations Jacobus Bulk Plant / Retail Station (Former) - 111 E. Decorah Road, West Bend, Wisconsin Project Reference #6662											
Monitoring Well	Top of Casing Elevation (ft MSL)	Ground Surface Elevation (ft MSL)	Depth to Product (feet TOC)	Depth to Water (feet TOC)	Depth to Water (feet bgs)	Product Thickness (ft)	Groundwater Elevation (ft MSL)	Well Screen Interval (ft MSL)	Free Product Removal Comments	Date	
MW-11	922.45	923.0	20.15	20.32	20.85	0.17	902.27	908.0 - 898.0 (15 - 25 ft bgs)		2/21/1994	
			20.18	20.24	20.77	0.06	902.26			3/4/1994	
			19.95	20.01	20.54	0.06	902.49			3/24/1994	
			20.10	20.40	20.93	0.30	902.31			6/9/1994	
			20.30	20.60	21.13	0.30	902.11			9/14/1994	
			20.45	20.60	21.13	0.15	901.98			9/26/1994	
			20.81	20.96	21.49	0.15	901.62			12/8/1994	
			20.60	20.70	21.23	0.10	901.84			5/16/1995	
			20.80	21.04	21.57	0.24	901.61			8/29/1995	
			20.60	21.70	22.23	1.10	901.69			1/16/1996	
			20.38	21.40	21.93	1.02	901.92			5/13/1996	
			---	19.92	20.45	---	902.53			6/21/1996	
			17.60	17.82	18.35	0.22	904.82			8/8/1996	
			---	19.98	20.51	---	902.47			10/24/1996	
			---	19.52	20.05	---	902.93			11/13/1996	
			20.30	20.36	20.89	0.06	902.14			2/5/1997	
			---	19.90	20.43	---	902.55			6/18/1997	
			---	20.36	20.89	---	902.09			11/20/1998	
			---	19.72	20.25	---	902.73			5/20/1999	
			---	19.81	20.34	---	902.64			11/10/1999	
			---	20.07	20.60	---	902.38			12/19/2001	
			20.87	20.89	21.42	0.02	901.58			FP removed*	3/17/2003
			20.88	21.01	21.54	0.13	901.55			FP removed**	12/30/2003
			---	20.45	20.98	---	902.00				4/13/2006
			---	19.68	20.21	---	902.77				2/25/2009
			---	20.02	20.55	---	902.43				3/21/2011
			---	18.96	19.49	---	903.49				5/11/2011
			---	19.06	19.59	---	903.39				6/14/2011
			---	19.28	19.81	---	903.17			Vac truck: GW & FP removed*****	7/14/2011
			---	19.40	19.93	---	903.05				8/4/2011
			---	19.46	19.99	---	902.99			Vac truck: GW & FP removed*****	8/17/2011
			---	19.69	20.22	---	902.76			Vac truck: GW & FP removed*****	9/19/2011
---	19.66	20.19	---	902.79	Vac truck: GW & FP	10/20/2011					
---	19.80	20.33	---	902.65		11/4/2011					
---	19.51	20.04	---	902.94		6/7/2012					

<p align="center">Table 2 Static Groundwater Elevations Jacobus Bulk Plant / Retail Station (Former) - 111 E. Decorah Road, West Bend, Wisconsin Project Reference #6662</p>										
Monitoring Well	Top of Casing Elevation (ft MSL)	Ground Surface Elevation (ft MSL)	Depth to Product (feet TOC)	Depth to Water (feet TOC)	Depth to Water (feet bgs)	Product Thickness (ft)	Groundwater Elevation (ft MSL)	Well Screen Interval (ft MSL)	Free Product Removal Comments	Date
MW-12	923.60	924.1	---	19.70	20.16	---	903.90	910.1 - 900.1 (14 - 24 ft bgs)		1/20/1994
			---	19.96	20.42	---	903.64			2/21/1994
			---	20.02	20.48	---	903.58			3/4/1994
			---	19.90	20.36	---	903.70			3/24/1994
			---	19.97	20.43	---	903.63			6/9/1994
			---	20.10	20.56	---	903.50			9/14/1994
			---	20.64	21.10	---	902.96			12/8/1994
			---	20.60	21.06	---	903.00			5/16/1995
			---	20.64	21.10	---	902.96			8/29/1995
			---	20.58	21.04	---	903.02			1/16/1996
			---	20.72	21.18	---	902.88			2/6/1996
			---	19.80	20.26	---	903.80			5/13/1996
			---	19.55	20.01	---	904.05			6/21/1996
			---	18.90	19.36	---	904.70			8/8/1996
			---	19.52	19.98	---	904.08			10/24/1996
			---	19.54	20.00	---	904.06			11/13/1996
			---	20.01	20.47	---	903.59			2/5/1997
			---	19.51	19.97	---	904.09			6/18/1997
			---	20.04	20.50	---	903.56			11/20/1998
			---	19.45	19.91	---	904.15			5/20/1999
			---	19.41	19.87	---	904.19			11/10/1999
			---	19.75	20.21	---	903.85			12/19/2001
			---	20.65	21.11	---	902.95			3/17/2003
			---	20.67	21.13	---	902.93			12/30/2003
			---	20.20	20.66	---	903.40			4/13/2006
			---	19.39	19.85	---	904.21			2/25/2009
			---	19.93	20.39	---	903.67			3/21/2011
			---	NM	---	---	---			5/11/2011
			---	NM	---	---	---			6/14/2011
			---	18.81	19.27	---	904.79			7/14/2011
			---	18.97	19.43	---	904.63			8/4/2011
			---	19.06	19.52	---	904.54			8/17/2011
---	19.29	19.75	---	904.31	9/19/2011					
---	19.26	19.72	---	904.34	10/20/2011					
---	19.42	19.88	---	904.18	11/4/2011					
---	19.12	19.58	---	904.48	6/7/2012					

<p align="center">Table 2 Static Groundwater Elevations Jacobus Bulk Plant / Retail Station (Former) - 111 E. Decorah Road, West Bend, Wisconsin Project Reference #6662</p>										
Monitoring Well	Top of Casing Elevation (ft MSL)	Ground Surface Elevation (ft MSL)	Depth to Product (feet TOC)	Depth to Water (feet TOC)	Depth to Water (feet bgs)	Product Thickness (ft)	Groundwater Elevation (ft MSL)	Well Screen Interval (ft MSL)	Free Product Removal Comments	Date
MW-13	925.10	925.6	---	20.08	20.53	---	905.02	910.6 - 900.6 (15 - 25 ft bgs)		1/20/1994
			---	20.40	20.85	---	904.70			2/21/1994
			---	20.50	20.95	---	904.60			3/4/1994
			---	20.34	20.79	---	904.76			3/24/1994
			---	20.45	20.90	---	904.65			6/9/1994
			---	20.74	21.19	---	904.36			9/14/1994
			---	21.38	21.83	---	903.72			12/8/1994
			---	21.30	21.75	---	903.80			5/16/1995
			---	21.48	21.93	---	903.62			8/29/1995
			---	21.40	21.85	---	903.70			1/16/1996
			---	21.48	21.93	---	903.62			2/6/1996
			---	19.80	20.25	---	905.30			5/13/1996
			---	19.50	19.95	---	905.60			6/21/1996
			---	19.10	19.55	---	906.00			8/8/1996
			---	19.70	20.15	---	905.40			10/24/1996
			---	19.44	19.89	---	905.66			11/13/1996
			---	20.58	21.03	---	904.52			2/5/1997
			---	19.96	20.41	---	905.14			6/18/1997
			---	20.74	21.19	---	904.36			11/20/1998
			---	19.87	20.32	---	905.23			5/20/1999
			---	19.77	20.22	---	905.33			11/10/1999
			---	20.24	20.69	---	904.86			12/19/2001
			---	21.41	21.86	---	903.69			3/17/2003
			---	21.56	22.01	---	903.54			12/30/2003
			---	21.03	21.48	---	904.07			4/13/2006
			---	19.93	20.38	---	905.17			2/25/2009
			---	20.61	21.06	---	904.49			3/21/2011
			---	NM	---	---	---			5/11/2011
			---	NM	---	---	---			6/14/2011
			---	19.23	19.68	---	905.87			7/14/2011
---	19.41	19.86	---	905.69	8/4/2011					
---	19.49	19.94	---	905.61	8/17/2011					
---	19.76	20.21	---	905.34	9/19/2011					
---	19.77	20.22	---	905.33	10/20/2011					
---	19.93	20.38	---	905.17	11/4/2011					
---	19.70	20.15	---	905.40	6/7/2012					

<p align="center">Table 2 Static Groundwater Elevations Jacobus Bulk Plant / Retail Station (Former) - 111 E. Decorah Road, West Bend, Wisconsin Project Reference #6662</p>										
Monitoring Well	Top of Casing Elevation (ft MSL)	Ground Surface Elevation (ft MSL)	Depth to Product (feet TOC)	Depth to Water (feet TOC)	Depth to Water (feet bgs)	Product Thickness (ft)	Groundwater Elevation (ft MSL)	Well Screen Interval (ft MSL)	Free Product Removal Comments	Date
MW-14	925.45	923.3	---	20.05	17.90	---	905.40	908.3 - 898.3 (15 - 25 ft bgs)		1/20/1994
			---	19.74	17.59	---	905.71			2/21/1994
			---	19.78	17.63	---	905.67			3/24/1994
			---	20.20	18.05	---	905.25			6/9/1994
			---	20.58	18.43	---	904.87			9/14/1994
			---	20.92	18.77	---	904.53			12/8/1994
			---	20.52	18.37	---	904.93			5/16/1995
			---	20.63	18.48	---	904.82			8/29/1995
			---	21.08	18.93	---	904.37			1/16/1996
			---	20.48	18.33	---	904.97			5/13/1996
			---	18.93	16.78	---	906.52			6/21/1996
			---	19.82	17.67	---	905.63			8/8/1996
			---	19.85	17.70	---	905.60			10/24/1996
			---	19.99	17.84	---	905.46			11/13/1996
			---	20.24	18.09	---	905.21			2/5/1997
			---	19.74	17.59	---	905.71			6/18/1997
			---	20.34	18.19	---	905.11			11/19/1998
			---	18.72	16.57	---	906.73			5/20/1999
			---	18.88	16.73	---	906.57			8/26/1999
			---	19.63	17.48	---	905.82			11/10/1999
			---	19.57	17.42	---	905.88			12/19/2001
			---	20.91	18.76	---	904.54			3/17/2003
			---	21.26	19.11	---	904.19			12/30/2003
			---	19.67	17.52	---	905.78			4/13/2006
			---	18.62	16.47	---	906.83			2/25/2009
			---	18.47	16.32	---	906.98			3/21/2011
			---	NM	---	---	---			5/11/2011
			---	NM	---	---	---			6/14/2011
			---	18.56	16.41	---	906.89			7/14/2011
			---	18.64	16.49	---	906.81			8/4/2011
			---	18.56	16.41	---	906.89			8/17/2011
			---	19.05	16.90	---	906.40			9/19/2011
---	18.92	16.77	---	906.53	10/20/2011					
---	19.13	16.98	---	906.32	11/4/2011					
---	18.67	16.52	---	906.78	6/7/2012					

<p align="center">Table 2 Static Groundwater Elevations Jacobus Bulk Plant / Retail Station (Former) - 111 E. Decorah Road, West Bend, Wisconsin Project Reference #6662</p>														
Monitoring Well	Top of Casing Elevation (ft MSL)	Ground Surface Elevation (ft MSL)	Depth to Product (feet TOC)	Depth to Water (feet TOC)	Depth to Water (feet bgs)	Product Thickness (ft)	Groundwater Elevation (ft MSL)	Well Screen Interval (ft MSL)	Free Product Removal Comments	Date				
MW-15	919.32	919.7	---	17.52	17.90	---	901.80	907.7 - 897.2 (12 - 22.5 ft bgs)		1/29/1996				
			---	17.00	17.38	---	902.32		1/30/1996					
			---	17.66	18.04	---	901.66		2/6/1996					
			---	17.54	17.92	---	901.78		3/6/1996					
			---	16.51	16.89	---	902.81		6/21/1996					
			---	16.30	16.68	---	903.02		8/8/1996					
			---	16.79	17.17	---	902.53		10/24/1996					
			---	16.80	17.18	---	902.52		11/13/1996					
			---	17.15	17.53	---	902.17		2/5/1997					
			---	16.67	17.05	---	902.65		6/18/1997					
			---	17.15	17.53	---	902.17		11/19/1998					
			---	16.42	16.80	---	902.90		5/20/1999					
			---	16.12	16.50	---	903.20		8/26/1999					
			---	16.66	17.04	---	902.66		11/10/1999					
			---	16.88	17.26	---	902.44		12/19/2001					
			---	17.68	18.06	---	901.64		3/17/2003					
			---	17.73	18.11	---	901.59		12/30/2003					
			---	17.13	17.51	---	902.19		4/13/2006					
			---	16.51	16.89	---	902.81		2/25/2009					
						Ice obstruction (likely due to remaining frost in ground; well in bare pavement area) at 1.5 feet TOC							3/21/2011	
						---	NM		---	---				5/11/2011
						Car parked over monitoring well							6/14/2011	
						Car parked over monitoring well							7/14/2011	
						---	16.26		16.64	---	903.06			8/4/2011
						---	16.27		16.65	---	903.05			8/17/2011
						Car parked over monitoring well							9/19/2011	
						---	16.51		16.89	---	902.81			10/20/2011
			---	16.67	17.05	---	902.65			11/4/2011				
			---	16.35	16.73	---	902.97			6/7/2012				

Table 2 Static Groundwater Elevations Jacobus Bulk Plant / Retail Station (Former) - 111 E. Decorah Road, West Bend, Wisconsin Project Reference #6662										
Monitoring Well	Top of Casing Elevation (ft MSL)	Ground Surface Elevation (ft MSL)	Depth to Product (feet TOC)	Depth to Water (feet TOC)	Depth to Water (feet bgs)	Product Thickness (ft)	Groundwater Elevation (ft MSL)	Well Screen Interval (ft MSL)	Free Product Removal Comments	Date
MW-16	923.63	924.1	---	22.73	23.20	---	900.90	904.6 - 894.1 (19.5 - 30 ft bgs)		1/29/1996
			---	22.73	23.20	---	900.90		1/30/1996	
			---	22.80	23.27	---	900.83		2/6/1996	
			---	22.76	23.23	---	900.87		3/24/1996	
			---	21.92	22.39	---	901.71		6/21/1996	
			---	21.55	22.02	---	902.08		8/8/1996	
			---	22.00	22.47	---	901.63		10/24/1996	
			---	21.99	22.46	---	901.64		11/13/1996	
			---	22.30	22.77	---	901.33		2/5/1997	
			---	21.95	22.42	---	901.68		6/18/1997	
			---	22.30	22.77	---	901.33		11/20/1998	
			---	21.71	22.18	---	901.92		5/20/1999	
			---	21.32	21.79	---	902.31		8/26/1999	
			---	21.84	22.31	---	901.79		11/10/1999	
			---	22.08	22.55	---	901.55		12/19/2001	
			---	22.83	23.30	---	900.80		3/17/2003	
			---	22.91	23.38	---	900.72		12/30/2003	
			22.40	22.42	22.89	0.02	901.23		FP removed***	4/13/2006
			---	21.79	22.26	---	901.84			2/25/2009
			---	22.07	22.54	---	901.56			3/21/2011
			---	21.17	21.64	---	902.46			5/11/2011
			---	21.27	21.74	---	902.36		Vac truck: GW & FP removed*****	6/14/2011
			---	21.46	21.93	---	902.17		Vac truck: GW & FP removed*****	7/14/2011
			---	21.58	22.05	---	902.05			8/4/2011
			---	21.62	22.09	---	902.01		Vac truck: GW & FP removed*****	8/17/2011
			---	21.83	22.30	---	901.80		Vac truck: GW & FP removed*****	9/19/2011
---	21.80	22.27	---	901.83	Vac truck: GW & FP	10/20/2011				
---	21.94	22.41	---	901.69		11/4/2011				
---	21.67	22.14	---	901.96		6/7/2012				

<p align="center">Table 2 Static Groundwater Elevations Jacobus Bulk Plant / Retail Station (Former) - 111 E. Decorah Road, West Bend, Wisconsin Project Reference #6662</p>										
Monitoring Well	Top of Casing Elevation (ft MSL)	Ground Surface Elevation (ft MSL)	Depth to Product (feet TOC)	Depth to Water (feet TOC)	Depth to Water (feet bgs)	Product Thickness (ft)	Groundwater Elevation (ft MSL)	Well Screen Interval (ft MSL)	Free Product Removal Comments	Date
MW-17	926.72	927.2	---	26.14	26.62	---	900.58	904.7 - 894.2 (22.5 - 33 ft bgs)		1/29/1996
			---	26.17	26.65	---	900.55			1/30/1996
			---	26.22	26.70	---	900.50			2/6/1996
			---	26.19	26.67	---	900.53			3/6/1996
			---	25.36	25.84	---	901.36			6/21/1996
			---	25.10	25.58	---	901.62			8/8/1996
			---	25.46	25.94	---	901.26			10/24/1996
			---	25.46	25.94	---	901.26			11/13/1996
			---	25.78	26.26	---	900.94			2/5/1997
			---	25.43	25.91	---	901.29			6/18/1997
			---	25.73	26.21	---	900.99			11/19/1998
			---	25.19	25.67	---	901.53			5/20/1999
			---	24.79	25.27	---	901.93			8/26/1999
			---	25.30	25.78	---	901.42			11/10/1999
			---	25.54	26.02	---	901.18			12/19/2001
			---	26.25	26.73	---	900.47			3/17/2003
			---	26.34	26.82	---	900.38			12/30/2003
			---	25.91	26.39	---	900.81			4/13/2006
			---	25.26	25.74	---	901.46			2/25/2009
			---	25.50	25.98	---	901.22			3/21/2011
			---	NM	---	---	---			5/11/2011
			---	24.83	25.31	---	901.89			6/14/2011
			---	25.00	25.48	---	901.72			7/14/2011
			---	25.11	25.59	---	901.61			8/4/2011
			---	25.15	25.63	---	901.57			8/17/2011
			---	25.34	25.82	---	901.38			9/19/2011
---	25.33	25.81	---	901.39	10/20/2011					
---	25.43	25.91	---	901.29	11/4/2011					
---	25.19	25.67	---	901.53	6/7/2012					

<p align="center">Table 2 Static Groundwater Elevations Jacobus Bulk Plant / Retail Station (Former) - 111 E. Decorah Road, West Bend, Wisconsin Project Reference #6662</p>										
Monitoring Well	Top of Casing Elevation (ft MSL)	Ground Surface Elevation (ft MSL)	Depth to Product (feet TOC)	Depth to Water (feet TOC)	Depth to Water (feet bgs)	Product Thickness (ft)	Groundwater Elevation (ft MSL)	Well Screen Interval (ft MSL)	Free Product Removal Comments	Date
MW-18	926.20	926.6	---	25.77	26.17	---	900.43	905.1 - 894.6 (21.5 - 32 ft bgs)		1/29/1996
			---	25.74	26.14	---	900.46		1/30/1996	
			---	25.81	26.21	---	900.39		2/6/1996	
			---	25.78	26.18	---	900.42		3/6/1996	
			---	24.98	25.38	---	901.22		6/21/1996	
			---	24.88	25.28	---	901.32		8/8/1996	
			---	25.07	25.47	---	901.13		10/24/1996	
			---	25.09	25.49	---	901.11		11/13/1996	
			---	25.35	25.75	---	900.85		2/5/1997	
			---	25.01	25.41	---	901.19		6/18/1997	
			---	25.34	25.74	---	900.86		11/20/1998	
			---	24.79	25.19	---	901.41		5/20/1999	
			---	23.82	24.22	---	902.38		8/26/1999	
			---	24.92	25.32	---	901.28		11/10/1999	
			---	25.15	25.55	---	901.05		12/19/2001	
			---	25.85	26.25	---	900.35		3/17/2003	
			---	25.94	26.34	---	900.26		12/30/2003	
			---	25.50	25.90	---	900.70		4/13/2006	
			---	24.89	25.29	---	901.31		2/25/2009	
			---	25.13	25.53	---	901.07		3/21/2011	
			---	NM	---	---	---		5/11/2011	
			---	24.45	24.85	---	901.75		6/14/2011	
			---	24.65	25.05	---	901.55		7/14/2011	
			---	24.73	25.13	---	901.47		8/4/2011	
			---	24.77	25.17	---	901.43		8/17/2011	
			---	24.95	25.35	---	901.25		9/19/2011	
---	24.94	25.34	---	901.26	10/20/2011					
---	25.05	25.45	---	901.15	11/4/2011					
---	24.17	24.57	---	902.03	6/7/2012					

<p align="center">Table 2 Static Groundwater Elevations Jacobus Bulk Plant / Retail Station (Former) - 111 E. Decorah Road, West Bend, Wisconsin Project Reference #6662</p>										
Monitoring Well	Top of Casing Elevation (ft MSL)	Ground Surface Elevation (ft MSL)	Depth to Product (feet TOC)	Depth to Water (feet TOC)	Depth to Water (feet bgs)	Product Thickness (ft)	Groundwater Elevation (ft MSL)	Well Screen Interval (ft MSL)	Free Product Removal Comments	Date
MW-19	918.72	919.1	---	19.10	19.48	---	899.62	904.6 - 894.1 (14.5 - 25 ft bgs)		1/29/1996
			---	19.15	19.53	---	899.57		1/30/1996	
			---	19.23	19.61	---	899.49		2/6/1996	
			---	19.16	19.54	---	899.56		3/6/1996	
			---	18.20	18.58	---	900.52		6/21/1996	
			---	18.25	18.63	---	900.47		8/8/1996	
			---	18.60	18.98	---	900.12		10/24/1996	
			---	18.00	18.38	---	900.72		11/13/1996	
			---	17.83	18.21	---	900.89		2/5/1997	
			---	18.52	18.90	---	900.20		6/18/1997	
			---	18.80	19.18	---	899.92		11/19/1998	
			---	18.20	18.58	---	900.52		5/20/1999	
			---	18.04	18.42	---	900.68		8/26/1999	
			---	18.49	18.87	---	900.23		11/10/1999	
			---	18.67	19.05	---	900.05		12/19/2001	
			---	19.26	19.64	---	899.46		3/17/2003	
			---	19.25	19.63	---	899.47		12/30/2003	
			---	18.80	19.18	---	899.92		4/13/2006	
			---	17.42	17.80	---	901.30		2/25/2009	
			---	17.71	18.09	---	901.01		3/21/2011	
			---	NM	---	---	---		5/11/2011	
			---	18.07	18.45	---	900.65		6/14/2011	
			---	18.24	18.62	---	900.48		7/14/2011	
			---	18.26	18.64	---	900.46		8/4/2011	
			---	18.30	18.68	---	900.42		8/17/2011	
			---	18.53	18.91	---	900.19		9/19/2011	
---	18.45	18.83	---	900.27	10/20/2011					
---	18.58	18.96	---	900.14	11/4/2011					
---	18.35	18.73	---	900.37	6/7/2012					

Table 2 Static Groundwater Elevations Jacobus Bulk Plant / Retail Station (Former) - 111 E. Decorah Road, West Bend, Wisconsin Project Reference #6662										
Monitoring Well	Top of Casing Elevation (ft MSL)	Ground Surface Elevation (ft MSL)	Depth to Product (feet TOC)	Depth to Water (feet TOC)	Depth to Water (feet bgs)	Product Thickness (ft)	Groundwater Elevation (ft MSL)	Well Screen Interval (ft MSL)	Free Product Removal Comments	Date
MW-20	927.97	928.3	---	27.88	28.21	---	900.09	903.7 - 893.3 (24.5 - 35 ft bgs)		1/29/1996
			---	27.93	28.26	---	900.04			1/30/1996
			---	27.98	28.31	---	899.99			2/6/1996
			---	27.95	28.28	---	900.02			3/6/1996
			---	27.26	27.59	---	900.71			6/21/1996
			---	26.90	27.23	---	901.07			8/8/1996
			---	27.26	27.59	---	900.71			10/24/1996
			---	26.89	27.22	---	901.08			11/13/1996
			---	27.55	27.88	---	900.42			2/5/1997
			---	27.24	27.57	---	900.73			6/18/1997
			---	27.52	27.85	---	900.45			11/19/1998
			---	27.96	28.29	---	900.01			5/20/1999
			---	26.67	27.00	---	901.30			8/26/1999
			---	27.13	27.46	---	900.84			11/10/1999
			---	27.35	27.68	---	900.62			12/19/2001
			---	28.04	28.37	---	899.93			3/17/2003
			---	28.11	28.44	---	899.86			12/30/2003
			---	27.66	27.99	---	900.31			4/13/2006
			---	27.14	27.47	---	900.83			2/25/2009
			---	27.28	27.61	---	900.69			3/21/2011
			---	NM	---	---	---			5/11/2011
			---	26.71	27.04	---	901.26			6/14/2011
			---	26.90	27.23	---	901.07			7/14/2011
			---	27.00	27.33	---	900.97			8/4/2011
			---	27.03	27.36	---	900.94			8/17/2011
			---	27.21	27.54	---	900.76			9/19/2011
			---	27.20	27.53	---	900.77			10/20/2011
			---	27.28	27.61	---	900.69			11/4/2011
---	27.07	27.40	---	900.90	6/7/2012					
MW-21	903.56	903.9	---	7.65	7.99	---	895.91	899.9 - 889.9 (4 - 14 ft bgs)		12/19/2001
			---	7.99	8.33	---	895.57			3/17/2003
			---	8.06	8.40	---	895.50			12/30/2003
			---	7.79	8.13	---	895.77			4/13/2006
			---	7.78	8.12	---	895.78			2/25/2009
			---	7.57	7.91	---	895.99			3/21/2011
			---	NM	---	---	---			5/11/2011
			---	7.66	8.00	---	895.90			6/14/2011
			---	7.73	8.07	---	895.83			7/14/2011
			---	7.73	8.07	---	895.83			8/4/2011
			---	7.73	8.07	---	895.83			8/17/2011
			---	7.78	8.12	---	895.78			9/19/2011
			---	7.78	8.12	---	895.78			10/20/2011
			---	7.81	8.15	---	895.75			11/4/2011
			---	7.77	8.11	---	895.79			6/7/2012

Table 2 Static Groundwater Elevations Jacobus Bulk Plant / Retail Station (Former) - 111 E. Decorah Road, West Bend, Wisconsin Project Reference #6662													
Monitoring Well	Top of Casing Elevation (ft MSL)	Ground Surface Elevation (ft MSL)	Depth to Product (feet TOC)	Depth to Water (feet TOC)	Depth to Water (feet bgs)	Product Thickness (ft)	Groundwater Elevation (ft MSL)	Well Screen Interval (ft MSL)	Free Product Removal Comments	Date			
MW-22	928.39	928.9	---	27.91	28.42	---	900.48	906.9 - 896.9 (22 - 32 ft bgs)		2/25/2009			
			---	28.08	28.59	---	900.31			3/21/2011			
			---	NM	---	---	---			5/11/2011			
			---	27.52	28.03	---	900.87			6/14/2011			
			---	27.70	28.21	---	900.69			7/14/2011			
			---	27.78	28.29	---	900.61			8/4/2011			
			---	27.81	28.32	---	900.58			8/17/2011			
			---	27.98	28.49	---	900.41			9/19/2011			
			No measurement - rain water ponded over well & would flood well vault			---	28.07			28.58	---	900.32	10/20/2011
			---	27.86	28.37	---	900.53			11/4/2011			
			---									6/7/2012	
			MW-23	925.26	925.5	---	19.39			19.67	---	905.87	912.8 - 902.8 (12.7 - 22.7 ft bgs)
MW-24	924.81	925.1	---	20.10	20.42	---	904.71	910.9 - 900.9 (14.2 - 24.2 ft bgs)		6/7/2012			
MW-25	922.04	922.5	---	15.33	15.82	---	906.71	912.4 - 902.4 (10.1 - 20.1 ft bgs)		6/7/2012			
RW-1	921.19	922.0	---	22.65	23.44	---	898.54	911.0 - 891.0 +/- (11 - 31 ft bgs +/-)		1/11/1994			
			---	18.20	18.99	---	902.99			1/26/1994			
			---	22.90	23.69	---	898.29			6/9/1994			
			---	16.02	16.81	---	905.17			5/16/1995			
			---	23.00	23.79	---	898.19			9/18/1995			
			24.20	24.24	25.03	0.04	896.98			1/16/1996			
			---	23.45	24.24	---	897.74			5/13/1996			
			---	23.30	24.09	---	897.89			6/21/1996			
			---	14.45	15.24	---	906.74			8/8/1996			
			---	14.50	15.29	---	906.69			11/13/1996			
			---	15.43	16.22	---	905.76			6/18/1997			
			---	16.07	16.86	---	905.12			11/20/1998			
			---	14.37	15.16	---	906.82			6/3/1999			
			---	14.51	15.30	---	906.68			8/26/1999			
			---	14.61	15.40	---	906.58			11/10/1999			
			---	NM	---	---	---			12/19/2001			
			---	NM	---	---	---			3/17/2003			
			---	NM	---	---	---			12/30/2003			
			---	15.15	15.94	---	906.04			4/13/2006			
			---	14.72	15.51	---	906.47			2/25/2009			
			---	14.45	15.24	---	906.74			3/21/2011			
			---	13.02	13.81	---	908.17			Vac truck: GW & FP removed**** 5/11/2011			
			---	14.02	14.81	---	907.17			Vac truck: GW & FP removed***** 6/14/2011			
			---	14.45	15.24	---	906.74			Vac truck: GW & FP removed***** 7/14/2011			
---	14.68	15.47	---	906.51	8/4/2011								
---	14.60	15.39	---	906.59	Vac truck: GW & FP removed***** 8/17/2011								
---	15.07	15.86	---	906.12	Vac truck: GW & FP removed***** 9/19/2011								
---	14.90	15.69	---	906.29	Vac truck: GW & FP 10/20/2011								
---	15.14	15.93	---	906.05	11/4/2011								
---	14.66	15.45	---	906.53	6/7/2012								

Table 2 Static Groundwater Elevations Jacobus Bulk Plant / Retail Station (Former) - 111 E. Decorah Road, West Bend, Wisconsin Project Reference #6662										
Monitoring Well	Top of Casing Elevation (ft MSL)	Ground Surface Elevation (ft MSL)	Depth to Product (feet TOC)	Depth to Water (feet TOC)	Depth to Water (feet bgs)	Product Thickness (ft)	Groundwater Elevation (ft MSL)	Well Screen Interval (ft MSL)	Free Product Removal Comments	Date
RW-2	920.75	921.4	---	19.56	20.24	---	901.19	910.4 - 890.4 +/- (11 - 31 ft bgs +/-)		1/11/1994
			---	17.43	18.11	---	903.32			1/26/1994
			---	18.35	19.03	---	902.40			3/4/1994
			---	17.88	18.56	---	902.87			6/9/1994
			---	16.25	16.93	---	904.50			5/16/1995
			15.67	15.68	16.36	0.01	905.08			9/18/1995
			---	23.88	24.56	---	896.87			1/16/1996
			---	15.52	16.20	---	905.23			5/13/1996
			---	12.60	13.28	---	908.15			6/21/1996
			---	14.50	15.18	---	906.25			8/8/1996
			---	19.75	20.43	---	901.00			11/13/1996
			---	15.34	16.02	---	905.41			6/18/1997
			---	15.96	16.64	---	904.79			11/20/1998
			---	14.50	15.18	---	906.25			6/3/1999
			---	14.45	15.13	---	906.30			8/26/1999
			---	14.92	15.60	---	905.83			11/10/1999
			---	NM	---	---	---			12/19/2001
			---	NM	---	---	---			3/17/2003
			---	NM	---	---	---			12/30/2003
			---	15.29	15.97	---	905.46			4/13/2006
			---	14.98	15.66	---	905.77			2/25/2009
			---	14.72	15.40	---	906.03			3/21/2011
			---	NM	---	---	---			5/11/2011
			---	13.83	14.51	---	906.92			6/14/2011
			---	14.24	14.92	---	906.51			7/14/2011
			---	14.40	15.08	---	906.35			8/4/2011
			---	14.40	15.08	---	906.35			8/17/2011
			---	14.84	15.52	---	905.91			9/19/2011
			---	14.75	15.43	---	906.00			10/20/2011
			---	14.97	15.65	---	905.78			11/4/2011
---	14.35	15.03	---	906.40	6/7/2012					

Table 2 Static Groundwater Elevations Jacobus Bulk Plant / Retail Station (Former) - 111 E. Decorah Road, West Bend, Wisconsin Project Reference #6662										
Monitoring Well	Top of Casing Elevation (ft MSL)	Ground Surface Elevation (ft MSL)	Depth to Product (feet TOC)	Depth to Water (feet TOC)	Depth to Water (feet bgs)	Product Thickness (ft)	Groundwater Elevation (ft MSL)	Well Screen Interval (ft MSL)	Free Product Removal Comments	Date
RW-3	921.38	922.0	19.90	20.25	20.84	0.35	901.43	911.0 - 891.0 +/- (11 - 31 ft bgs +/-)		1/11/1994
			21.50	22.45	23.04	0.95	899.74			1/26/1994
			24.02	24.15	24.74	0.13	897.34			3/4/1994
			21.70	21.80	22.39	0.10	899.67			6/9/1994
			23.20	23.40	23.99	0.20	898.15			12/8/1994
			24.25	24.35	24.94	0.10	897.12			5/16/1995
			18.00	18.20	18.79	0.20	903.35			9/18/1995
			---	20.12	20.71	---	901.26			1/16/1996
			18.05	18.20	18.79	0.15	903.31			5/13/1996
			---	24.30	24.89	---	897.08			6/21/1996
			15.46	15.53	16.12	0.07	905.91			8/8/1996
			---	23.10	23.69	---	898.28			11/13/1996
			16.48	16.65	17.24	0.17	904.87			6/18/1997
			17.02	17.24	17.83	0.22	904.33			11/20/1998
			15.87	16.04	16.63	0.17	905.48			6/3/1999
			15.60	15.80	16.39	0.20	905.75			8/26/1999
			16.21	16.39	16.98	0.18	905.14			11/10/1999
			---	NM	---	---	---			12/19/2001
			---	NM	---	---	---			3/17/2003
			---	NM	---	---	---			12/30/2003
			---	16.75	17.34	---	904.63			4/13/2006
			---	16.17	16.76	---	905.21			2/25/2009
			---	16.31	16.90	---	905.07			3/21/2011
			---	14.90	15.49	---	906.48			Vac truck: GW & FP removed**** 5/11/2011
			---	15.24	15.83	---	906.14			Vac truck: GW & FP removed***** 6/14/2011
			---	15.55	16.14	---	905.83			Vac truck: GW & FP removed***** 7/14/2011
			---	15.69	16.28	---	905.69			8/4/2011
			---	15.73	16.32	---	905.65			Vac truck: GW & FP removed***** 8/17/2011
			16.15	16.16	16.75	0.01	905.23			Vac truck: GW & FP removed***** 9/19/2011
			---	16.00	16.59	---	905.38			Vac truck: GW & FP 10/20/2011
---	16.30	16.89	---	905.08	11/4/2011					
---	15.76	16.35	---	905.62	6/7/2012					

Table 2 Static Groundwater Elevations Jacobus Bulk Plant / Retail Station (Former) - 111 E. Decorah Road, West Bend, Wisconsin Project Reference #6662										
Monitoring Well	Top of Casing Elevation (ft MSL)	Ground Surface Elevation (ft MSL)	Depth to Product (feet TOC)	Depth to Water (feet TOC)	Depth to Water (feet bgs)	Product Thickness (ft)	Groundwater Elevation (ft MSL)	Well Screen Interval (ft MSL)	Free Product Removal Comments	Date
RW-4	921.73	922.6	20.80	22.10	22.92	1.30	900.74	911.6 - 891.6 +/- (11 - 31 ft bgs +/-)		1/11/1994
			20.60	21.60	22.42	1.00	900.98		1/26/1994	
			---	24.22	25.04	---	897.51		3/4/1994	
			---	24.41	25.23	---	897.32		6/9/1994	
			25.20	25.26	26.08	0.06	896.52		12/8/1994	
			24.50	24.51	25.33	0.01	897.23		5/16/1995	
			18.15	18.16	18.98	0.01	903.58		9/18/1995	
			---	25.24	26.06	---	896.49		1/16/1996	
			18.00	18.65	19.47	0.65	903.63		5/13/1996	
			---	24.60	25.42	---	897.13		6/21/1996	
			16.23	16.60	17.42	0.37	905.44		8/8/1996	
			14.28	14.35	15.17	0.07	907.44		11/13/1996	
			17.33	17.83	18.65	0.50	904.33		6/18/1997	
			17.77	19.07	19.89	1.30	903.77		11/20/1998	
			16.85	17.67	18.49	0.82	904.76		6/3/1999	
			16.37	17.70	18.52	1.33	905.16		8/26/1999	
			17.19	17.91	18.73	0.72	904.43		11/10/1999	
			---	NM	---	---	---		12/19/2001	
			---	NM	---	---	---		3/17/2003	
			---	NM	---	---	---		12/30/2003	
			17.68	18.71	19.53	1.03	903.90		FP removed***	4/13/2006
			16.95	18.51	19.33	1.56	904.55		2 gallons FP removed	2/25/2009
			17.38	18.90	19.72	1.52	904.12		5.25 gallons FP removed	3/21/2011
			16.15	17.35	18.17	1.20	905.40		Vac truck: GW & FP removed****	5/11/2011
			16.30	16.35	17.17	0.05	905.42		Vac truck: GW & FP removed*****	6/14/2011
			16.66	16.70	17.52	0.04	905.06		Vac truck: GW & FP removed*****	7/14/2011
			---	16.82	17.64	---	904.91			8/4/2011
			16.81	16.83	17.65	0.02	904.92		Vac truck: GW & FP removed*****	8/17/2011
			17.13	17.15	17.97	0.02	904.60		Vac truck: GW & FP removed*****	9/19/2011
			17.10	17.12	17.94	0.02	904.63		Vac truck: GW & FP	10/20/2011
			17.30	17.31	18.13	0.01	904.43			11/4/2011
			16.90	16.94	17.76	0.04	904.82		<0.25 gallon FP removed	6/7/2012

Table 2 Static Groundwater Elevations Jacobus Bulk Plant / Retail Station (Former) - 111 E. Decorah Road, West Bend, Wisconsin Project Reference #6662										
Monitoring Well	Top of Casing Elevation (ft MSL)	Ground Surface Elevation (ft MSL)	Depth to Product (feet TOC)	Depth to Water (feet TOC)	Depth to Water (feet bgs)	Product Thickness (ft)	Groundwater Elevation (ft MSL)	Well Screen Interval (ft MSL)	Free Product Removal Comments	Date
RW-5	921.24	922.2	19.95	20.45	21.44	0.50	901.22	911.2 - 891.2 +/- (11 - 31 ft bgs +/-)		1/11/1994
			19.40	19.60	20.59	0.20	901.81		1/26/1994	
			16.30	16.54	17.53	0.24	904.90		3/4/1994	
			20.20	20.30	21.29	0.10	901.03		6/9/1994	
			16.40	16.50	17.49	0.10	904.83		5/16/1995	
			18.01	18.15	19.14	0.14	903.21		8/19/1995	
			21.14	21.26	22.25	0.12	900.08		1/16/1996	
			---	22.24	23.23	---	899.00		5/13/1996	
			---	20.80	21.79	---	900.44		6/21/1996	
			15.29	15.38	16.37	0.09	905.94		8/8/1996	
			---	14.99	15.98	---	906.25		11/13/1996	
			---	15.39	16.38	---	905.85		6/18/1997	
			16.01	16.02	17.01	0.01	905.23		11/20/1998	
			14.62	14.64	15.63	0.02	906.62		6/3/1999	
			14.45	14.65	15.64	0.20	906.76		8/26/1999	
			14.85	14.86	15.85	0.01	906.39		11/10/1999	
			---	NM	---	---	---		12/19/2001	
			---	NM	---	---	---		3/17/2003	
			---	NM	---	---	---		12/30/2003	
			15.31	15.55	16.54	0.24	905.89		FP removed***	4/13/2006
			---	14.88	15.87	---	906.36		---	2/25/2009
			---	14.86	15.85	---	906.38		---	3/21/2011
			---	13.45	14.44	---	907.79		---	Vac truck: GW & FP removed****
			---	13.93	14.92	---	907.31		---	Vac truck: GW & FP removed*****
			---	14.35	15.34	---	906.89		---	Vac truck: GW & FP removed*****
			---	14.65	15.64	---	906.59		---	8/4/2011
			---	14.55	15.54	---	906.69		---	Vac truck: GW & FP removed*****
			---	15.04	16.03	---	906.20		---	Vac truck: GW & FP removed*****
---	14.87	15.86	---	906.37	---	Vac truck: GW & FP				
---	15.15	16.14	---	906.09	---	11/4/2011				
---	14.65	15.64	---	906.59	---	6/7/2012				

Table 2 Static Groundwater Elevations Jacobus Bulk Plant / Retail Station (Former) - 111 E. Decorah Road, West Bend, Wisconsin Project Reference #6662														
Monitoring Well	Top of Casing Elevation (ft MSL)	Ground Surface Elevation (ft MSL)	Depth to Product (feet TOC)	Depth to Water (feet TOC)	Depth to Water (feet bgs)	Product Thickness (ft)	Groundwater Elevation (ft MSL)	Well Screen Interval (ft MSL)	Free Product Removal Comments	Date				
RW-6	921.88	922.8	---	20.82	21.69	---	901.06	911.8 - 891.8 +/- (11 - 31 ft bgs +/-)		1/11/1994				
			---	21.40	22.27	---	900.48			1/26/1994				
			---	16.75	17.62	---	905.13			3/4/1994				
			---	21.96	22.83	---	899.92			6/9/1994				
			17.10	17.11	17.98	0.01	904.78			5/16/1995				
			22.20	22.22	23.09	0.02	899.68			8/19/1995				
			18.42	20.24	21.11	1.82	903.19			1/16/1996				
			---	23.06	23.93	---	898.82			5/13/1996				
			---	22.41	23.28	---	899.47			6/21/1996				
			14.92	14.93	15.80	0.01	906.96			8/8/1996				
			---	14.90	15.77	---	906.98			11/13/1996				
			---	16.13	17.00	---	905.75			6/18/1997				
			16.79	16.90	17.77	0.11	905.07			11/20/1998				
			15.48	15.51	16.38	0.03	906.40			6/3/1999				
			15.25	15.30	16.17	0.05	906.62			8/26/1999				
			15.85	15.88	16.75	0.03	906.03			11/10/1999				
			---	NM	---	---	---			---	12/19/2001			
			---	NM	---	---	---			---	3/17/2003			
			---	NM	---	---	---			---	12/30/2003			
			16.23	16.24	17.11	0.01	905.65			4/13/2006	FP removed***			
						Obstruction (possible foam insulation from well vault) at 6.4 feet TOC							2/25/2009	
			---	15.69	16.56	---	---			906.19	3/21/2011			
			---	14.35	15.22	---	---			907.53	5/11/2011	Vac truck: GW & FP removed****		
			---	14.74	15.61	---	---			907.14	6/14/2011	Vac truck: GW & FP removed*****		
			---	15.02	15.89	---	---			906.86	7/14/2011	Vac truck: GW & FP removed*****		
			---	15.38	16.25	---	---			906.50	8/4/2011			
			15.34	15.35	16.22	0.01	906.54			8/17/2011	Vac truck: GW & FP removed*****			
			15.70	15.71	16.58	0.01	906.18			9/19/2011	Vac truck: GW & FP removed*****			
			15.59	15.60	16.47	0.01	906.29			10/20/2011	Vac truck: GW & FP			
			---	15.11	15.98	---	---			906.77	11/4/2011			
---	15.44	16.31	---	---	906.44	6/7/2012								

Table 2 Static Groundwater Elevations Jacobus Bulk Plant / Retail Station (Former) - 111 E. Decorah Road, West Bend, Wisconsin Project Reference #6662												
Monitoring Well	Top of Casing Elevation (ft MSL)	Ground Surface Elevation (ft MSL)	Depth to Product (feet TOC)	Depth to Water (feet TOC)	Depth to Water (feet bgs)	Product Thickness (ft)	Groundwater Elevation (ft MSL)	Well Screen Interval (ft MSL)	Free Product Removal Comments	Date		
RW-7	921.51	922.5	---	21.62	22.59	---	899.89	911.5 - 891.5 +/- (11 - 31 ft bgs +/-)		1/11/1994		
			---	16.62	17.59	---	904.89			1/26/1994		
			---	16.53	17.50	---	904.98			3/4/1994		
			---	21.70	22.67	---	899.81			6/9/1994		
			---	16.74	17.71	---	904.77			5/16/1995		
			---	19.40	20.37	---	902.11			8/19/1995		
			---	21.88	22.85	---	899.63			1/16/1996		
			---	21.10	22.07	---	900.41			5/13/1996		
			---	23.15	24.12	---	898.36			6/21/1996		
			---	15.42	16.39	---	906.09			8/8/1996		
			---	15.50	16.47	---	906.01			11/13/1996		
			---	15.54	16.51	---	905.97			6/18/1997		
			---	16.18	17.15	---	905.33			11/20/1998		
			---	14.36	15.33	---	907.15			6/3/1999		
			---	14.49	15.46	---	907.02			8/26/1999		
			---	14.72	15.69	---	906.79			11/10/1999		
			---	NM	---	---	---			---	12/19/2001	
			---	NM	---	---	---			---	3/17/2003	
			---	NM	---	---	---			---	12/30/2003	
			---	15.14	15.15	16.12	0.01			906.37	FP removed***	4/13/2006
			---	---	14.75	15.72	---			906.76	---	2/25/2009
			---	---	14.49	15.46	---			907.02	---	3/21/2011
			---	---	12.72	13.69	---			908.79	Vac truck: GW & FP removed****	5/11/2011
			---	---	13.85	14.82	---			907.66	Vac truck: GW & FP removed*****	6/14/2011
			---	---	14.55	15.52	---			906.96	Vac truck: GW & FP removed*****	7/14/2011
			---	---	14.71	15.68	---			906.80	---	8/4/2011
			---	---	14.66	15.63	---			906.85	Vac truck: GW & FP removed*****	8/17/2011
			---	---	15.23	16.20	---			906.28	Vac truck: GW & FP removed*****	9/19/2011
			---	---	14.97	15.94	---			906.54	Vac truck: GW & FP	10/20/2011
			---	---	15.25	16.22	---			906.26	---	11/4/2011
---	---	14.51	15.48	---	907.00	---	6/7/2012					

<p align="center">Table 2 Static Groundwater Elevations Jacobus Bulk Plant / Retail Station (Former) - 111 E. Decorah Road, West Bend, Wisconsin Project Reference #6662</p>										
Monitoring Well	Top of Casing Elevation (ft MSL)	Ground Surface Elevation (ft MSL)	Depth to Product (feet TOC)	Depth to Water (feet TOC)	Depth to Water (feet bgs)	Product Thickness (ft)	Groundwater Elevation (ft MSL)	Well Screen Interval (ft MSL)	Free Product Removal Comments	Date
RW-8	921.91	922.4	---	NM	---	---	905.45	914.4 - 899.4 (8 - 23 ft bgs)		12/19/2001
			---	NM	---	---				3/17/2003
			---	NM	---	---				12/30/2003
			---	16.46	16.90	---				4/13/2006
			---	15.97	16.41	---				2/25/2009
			---	16.04	16.48	---				3/21/2011
			---	14.64	15.08	---				5/11/2011
			---	15.00	15.44	---				6/14/2011
			---	15.37	15.81	---				7/14/2011
			---	15.54	15.98	---				8/4/2011
			---	15.58	16.02	---				8/17/2011
			---	16.00	16.44	---				9/19/2011
			---	15.83	16.27	---				10/20/2011
			---	16.09	16.53	---				11/4/2011
			---	15.68	16.12	---				6/7/2012

Notes:

- Top of casing and ground surface elevations for MW-1 through MW-20 and RW-1 through RW-7 obtained from Montgomery Watson report dated February 23, 2000 (Tables 6 and 7).
- Top of casing and ground surface elevations for MW-21 surveyed by North Shore Engineering in January 2002.
- Top of casing and ground surface elevations for MW-22 and RW-8 surveyed by Sigma Environmental Services, Inc. on February 26, 2009.
- Top of casing and ground surface elevations for MW-6R, MW-23, MW-24, and MW-25 surveyed by Sigma on May 25, 2012 with a Trimble R8 GPS receiver.
- ft MSL = feet above Mean Sea Level
- ft bgs = feet below ground surface
- ft TOC = feet below top of casing
- Information prior to 2001 is from Montgomery Watson's data table from March 2000 case closure request.

* A total of several gallons of free product was removed in March 2003 from wells MW-3, MW-4, MW-5, MW-6, MW-10, and MW-11.
** A total of several gallons of free product was removed in December 2003 from wells MW-3, MW-4, MW-5, MW-6, and MW-11.
*** A total of 10 gallons of free product was removed in April 2006 from wells MW-3, MW-4, MW-5, MW-6, MW-16, RW-4, RW-5, RW-6, and RW-7 with disposable bailers.
**** A total of approximately 1,000 gallons of impacted groundwater and free product was removed from wells RW-1, RW-3 through RW-8, MW-1, and MW-3 through MW-6 with a vacuum truck.
***** A total of approximately 1,000 gallons of impacted groundwater and free product was removed from wells RW-1, RW-3 through RW-8, MW-1, MW-3 through MW-6, and MW-16 with a vacuum truck.
***** A total of approximately 1,000 gallons of impacted groundwater and free product was removed from wells RW-1, RW-3 through RW-8, MW-1, MW-3 through MW-6, MW-10, MW-11, and MW-16 with a vacuum truck.
***** A total of approximately 1,000 gallons of impacted groundwater and free product was removed from wells RW-1, RW-3 through RW-8, MW-1, MW-3 through MW-5, MW-10, MW-11, and MW-16 with a vacuum truck.

Impacted Off-Source Property Information

Form 4400-246 (R 3/08)

This fillable form is intended to provide a list of information that must be submitted for evaluation for case closure. It is to be used in conjunction with Form 4400-202, Case Closure Request (Section H). The closure of a case means that the Department has determined that no further response is required at that time based on the information that has been submitted to the Department.

NOTICE: Completion of this form is mandatory for applications for case closure pursuant to ch. 292, Wis. Stats. and ch. NR 726, Wis. Adm. Code, including cases closed under ch. NR 746 and ch. NR 726. The Department will not consider, or act upon your application, unless all applicable sections are completed on this form and the closure fee and any other applicable fees, required under ch. NR 749, Wis. Adm. Code, Table 1 are included. It is not the Department's intention to use any personally identifiable information from this form for any purpose other than reviewing closure requests and determining the need for additional response action. The Department may provide this information to requesters as required by Wisconsin's Open Records law [ss. 19.31 - 19.39, Wis. Stats.].

BRRTS #:

03-67-558530

ACTIVITY NAME: JACOBUS WEST BEND RETAIL STATION (FORMER)

ID	Off-Source Property Address	Parcel Number	WTM X	WTM Y
A	760 INDIANA AV	291_11191330020	667812	328229
B	773 INDIANA AV	291_11191330706	667894	328243
C				
D				
E				
F				
G				
H				
I				

December 12, 2012

Project Reference #6662

Mr. Joel Lederhause
JKA Enterprises LLC
1470 Pamme Ct.
West Bend, WI 53090

Certified Mail

**Subject: Notice of Residual Petroleum Hydrocarbon Soil and Groundwater Impacts
760 S. Indiana Avenue, West Bend, Wisconsin**

Dear Mr. Lederhause:

This letter is in regard to the investigation of a petroleum hydrocarbon release at 111 E. Decorah Road, West Bend, Wisconsin which has shown to have migrated onto your property referenced above. Jacobus Energy, Inc. (Jacobus) has conducted site investigation and remediation activities and will be requesting that the Wisconsin Department of Natural Resources (WDNR) grant case closure. Case closure means that the WDNR will not be requiring any further investigation or cleanup action to be taken. In conjunction with Sigma Environmental Services, Inc.'s (Sigma's) evaluation of the project, Jacobus is proposing that natural attenuation be relied upon for the 111 E. Decorah Road property and the 760 S. Indiana Avenue property as a means to further reduce residual soil and groundwater impacts over time.

The WDNR will not review the closure request for at least 30 days after the date of this letter. As an affected property owner, you have a right to contact the WDNR to provide any technical information that you may have that indicates that closure should not be granted for this site. If you would like to submit any information to the WDNR that is relevant to this closure request, you should mail that information to: Mr. John Feeney, WDNR Plymouth Service Center, Remediation & Redevelopment Program, 1155 Pilgrim Road, Plymouth, WI 53073.

Please review the enclosed legal description of your property and notify Adam Roder of Sigma within the next 30 days if the legal description is incorrect.

If closure for this site is approved by the WDNR, the following are some continuing obligations for which you will be responsible. WDNR publication PUB-RR-819 ("Continuing Obligations for Environmental Protection, Responsibilities of Wisconsin Property Owners") is included with this letter. If needed, a copy of this fact sheet can also be downloaded from the WDNR website.

- Groundwater contamination that appears to have originated on the 111 E. Decorah Road property has migrated onto you 760 S. Indiana Avenue property as shown in the attached Groundwater Quality Map. The levels of petroleum volatile organic compounds (PVOCs) and naphthalene in groundwater at your property are above

the NR 140 Enforcement Standards (ESs). If you intend to construct a new well, or reconstruct an existing well, you will need prior WDNR approval.

- The dissolved PVOC plume in groundwater is stable or receding and will degrade over time. Natural attenuation processes will continue to clean up the residual subsurface impacts such that the requirements for regulatory case closure found in NR 726 and NR 746 will be met; the WDNR will be requested to accept natural attenuation as a final remedy for this site and grant case closure. WDNR publication PUB-RR-619 ("Using Natural Attenuation to Clean Up Contaminated Groundwater: What Landowners Should Know") is included with this letter. If needed, a copy of this fact sheet can also be downloaded from the WDNR website.
- Soil contamination remains beneath a small portion of your 760 S. Indiana Avenue property as shown in the attached Soil Quality Map. If impacted soil is excavated in the future, the property owner at the time of excavation must sample and analyze the excavated soil to determine if residual contamination remains and whether the material would be considered solid or hazardous waste. Any storage, treatment, and/or disposal must be performed in compliance with applicable statutes and rules. Special precautions may be necessary during excavation activities to mitigate potential health risks during such work.
- While vapors are not of concern at this time, they may pose a health issue if buildings are constructed on your property in the future. If you intend to construct a building to be occupied in the vicinity of the residual impacts, you will first need to notify the WDNR. Vapor mitigation technologies may be required for construction of occupied buildings unless the vapor migration pathway is shown to not be a risk for such construction.

After the WDNR makes a decision on the closure request, it will be documented in a letter. If the WDNR grants closure, you will receive a copy of the closure letter. If needed, you may also obtain a copy of the closure letter by requesting a copy from Jacobus or Sigma, by writing to the WDNR address given above, or by accessing the WDNR Geographic Information System (GIS) Registry (via RR Sites Map) on the internet at <http://dnr.wi.gov/topic/Brownfields/clean.html>. The closure letter will be included as part of the file attached on the GIS Registry.

If this case is closed, all properties within the site boundaries where soil and/or groundwater contamination exceeds NR 720 generic RCLs and/or NR 140 ESs, respectively, will be listed on the WDNR's GIS Registry of Closed Remediation Sites. The information on the GIS Registry includes maps showing the location of properties in Wisconsin where soil and/or groundwater impacts above applicable standards were present at the time that the case was closed. The GIS Registry will be available to the general public on the WDNR's internet web site.

Should you or any subsequent property owner wish to construct or reconstruct a well on your property, special well construction standards may be necessary to protect the well from the residual contamination. Any well driller who proposes to construct a well on your property in the future will first need to obtain approval from a regional water supply specialist in DNR's Drinking Water and Groundwater Program. The well construction

application, form 3300-254, is on the internet at <http://dnr.wi.gov/topic/wells/documents/3300254.pdf>.

Finally, WDNR publication PUB-RR-589 ("When Contamination Crosses a Property Line - Rights and Responsibilities of Property Owners" is included with this letter to help further explain you rights and responsibilities as an affected property owner. If needed, a copy of this fact sheet can also be downloaded from the WDNR website.

If you need more information, you may contact Mike Helgesen of Jacobus (11815 W. Bradley Road, Milwaukee, WI 53224; phone number 414-577-0217) or Adam Roder of Sigma (1300 W. Canal Street, Milwaukee, WI 53233; phone number 414-643-4200).

Sincerely,

SIGMA ENVIRONMENTAL SERVICES, INC.



Adam J. Roder, P.E.
Senior Engineer

Enclosures:

Deed & Legal Description Information
Groundwater Quality Map
Soil Quality Map
PUB-RR-819
PUB-RR-671
PUB-RR-589

cc: Mr. Mike Helgesen - Jacobus Energy, Inc.

OFF-SOURCE
A
PROPERTY

UNITED STATES POSTAL SERVICE



First-Class Mail
Postage & Fees Paid
USPS
Permit No. G-10

• Sender: Please print your name, address, and ZIP+4 in this box •

THE SIGMA GROUP
1300 W. Canal Street
Milwaukee, WI 53233

Jacobus 6662-002 AJR



SENDER: COMPLETE THIS SECTION

- Complete items 1, 2, and 3. Also complete item 4 if Restricted Delivery is desired.
- Print your name and address on the reverse so that we can return the card to you.
- Attach this card to the back of the mailpiece, or on the front if space permits.

1. Article Addressed to:

J Lederhause
JICA
1470 Pamme Ct
West Bend, WI
53090

2. Article Number
(Transfer from service label)

7010 0780 0001 3301 1671

COMPLETE THIS SECTION ON DELIVERY

A. Signature

X

Agent
 Addressee

B. Received by (Printed Name)

C. Date of Delivery

12/14/12

D. Is delivery address different from item 1? Yes
If YES, enter delivery address below: No

Joe Miller

3. Service Type

Certified Mail Express Mail
 Registered Return Receipt for Merchandise
 Insured Mail C.O.D.

4. Restricted Delivery? (Extra Fee) Yes

OFF-SOURCE
A
PROPERTY

State Bar of Wisconsin Form 6-2003
SPECIAL WARRANTY DEED

DOC#: 1074323



Recorded
JAN. 04, 2005 AT 08:40AM
SHARON A. MARTIN
REGISTER OF DEEDS
WASHINGTON COUNTY, WI
Fee Amount: \$13.00
Transfer Fee: \$1950.00

Document Number

Document Name

THIS DEED, made between Serigraph Sales & Mfg. Co., Inc., now known as Serigraph Inc., a Delaware corporation

(“Grantor,” whether one or more), and JKA Enterprises, LLC, a Wisconsin limited liability company

(“Grantee,” whether one or more). Grantor for a valuable consideration, conveys to Grantee the following described real estate, together with the rents, profits, fixtures and other appurtenant interests, in Washington County, State of Wisconsin (“Property”) (if more space is needed, please attach addendum):

See Exhibit A attached hereto and made a part hereof.

Recording Area 13-2

Name and Return Address

Joel Lederhause
1470 Pamme Court
West Bend, WI 53090

The “As Is” Provisions in the Commercial Offer to Purchase between Grantor and Grantee accepted by Grantee on November 18, 2004 are incorporated herein at length.

1119-133-0020

Parcel Identification Number (PIN)

This is not homestead property.

Grantor warrants that the title to the Property is good, indefeasible, in fee simple and free and clear of encumbrances arising by, through, or under Grantor, except: municipal and zoning ordinances and agreements entered under them, recorded easements for the distribution of utility and municipal services, recorded building and use restrictions and covenants, general taxes levied in the year of closing and any matters which would be disclosed by an accurate survey of the Property and any other matters which do not render title unmarketable.

Dated December 30, 2004

SERIGRAPH INC.

TRANSFER

\$ 1,950.00

(SEAL) By

Wayne R. Grall

FEE

(SEAL)

* Wayne R. Grall, Executive Vice President

(SEAL)

(SEAL)

AUTHENTICATION

ACKNOWLEDGMENT

Signature(s) _____

STATE OF WISCONSIN)

authenticated on _____

WASHINGTON)

COUNTY)

) ss.

Personally came before me on December 30, 2004, the above-named Wayne R. Grall

TITLE: MEMBER STATE BAR OF WISCONSIN

(If not, _____ authorized by Wis. Stat. §706.06)

known to be the person(s) who executed the foregoing instrument and acknowledged the same

THIS INSTRUMENT DRAFTED BY:

Stephen L. Chernof
Godfrey & Kahn, S.C.

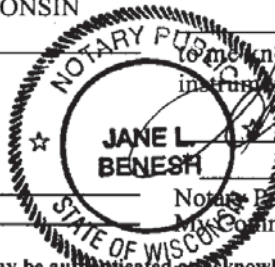

Jane L. Benesh
Notary Public, State of Wisconsin

Commission (is permanent) (expires: 11-26-06)

MW898797_1.DOC

(Signatures may be authenticated or acknowledged. Both are not necessary.)

NOTE: THIS IS A STANDARD FORM. ANY MODIFICATIONS TO THIS FORM SHOULD BE CLEARLY IDENTIFIED.

SPECIAL WARRANTY DEED

© 2003 STATE BAR OF WISCONSIN

FORM NO. 6-2003

* Type name below signatures.

EXHIBIT A

Legal Description

That part of Lot 1 in Block 1 of RIVERVIEW HEIGHTS, a subdivision in the City of West Bend, described as follows:

Beginning at the southeast corner of said Lot 1, being the intersection of the North line of Decorah Road with the westerly line of Indiana Avenue; thence North 0° 04' East 188.76 feet along the easterly line of said lot; thence North 17° 40' West 193.76 feet also along the easterly side of said lot; thence South 72° 20' West 175 feet; thence South 17° 40' East 335.95 feet to the south line of said lot; thence East along the south line of said Lot 123.36 feet to the place of beginning.

ALSO:

The southerly 10 feet of Parcel 1 and all of Parcels 2 and 3 of Certified Survey Map No. 2570 recorded in the Washington County Registry in Volume 14 of Certified Survey Maps on Page 71, as Document No. 457817 on August 23, 1983 and being a part of Lots 1 and 2 of Block 1 in RIVERVIEW HEIGHTS, a subdivision lying in the Southwest $\frac{1}{4}$ and the Southeast $\frac{1}{4}$ of Section 13, Town 11 North, Range 19 East in the City of West Bend, Washington County, Wisconsin.

Tax Key No.: 1119-133-0020

Property Address: 760 S. Indiana Avenue & 110 E. Decorah Road

OFF-SOURCE
A
PROPERTY

457817 CERTIFIED SURVEY MAP

Number 2570 Volume 14 Page 71

Certified Survey Maps of Washington County

I hereby certify that by the direction of Al Wolf, I have surveyed, divided and mapped the land shown and described hereon being that part of Lots 1 and 2 of Block 1 of Riverview Heights a subdivision lying in the SW 1/4 and the SE 1/4 of Section 13, Town 11 North, Range 19 East, in the City of West Bend, Washington County, Wisconsin, being described as follows:

Beginning at the Southwest corner of said Lot 1; thence N 17°40' W along the easterly right-of-way line of the Chicago & Northwestern railroad, 415.76 feet; thence N 72°20' E, 394.56 feet to a point on the Westerly right-of-way line of Indiana Avenue; thence S 17°40' E along said Westerly line, 150.00 feet; thence S 72°20' W, 175.00 feet; thence S 17°40' E, 335.95 feet to the Northerly line of Decorah Road; thence N 89°56' W along said Northerly line, 230.52 feet to the point of beginning.

Containing 2.88 acres more or less.

I further certify that I have fully complied with the provisions of section 236.34 of the Wisconsin Statutes in surveying, dividing and mapping said lands.

Citizens/Weis Corporation

Ronald A. Weis

Ronald A. Weis S-1215

July 8, 1983

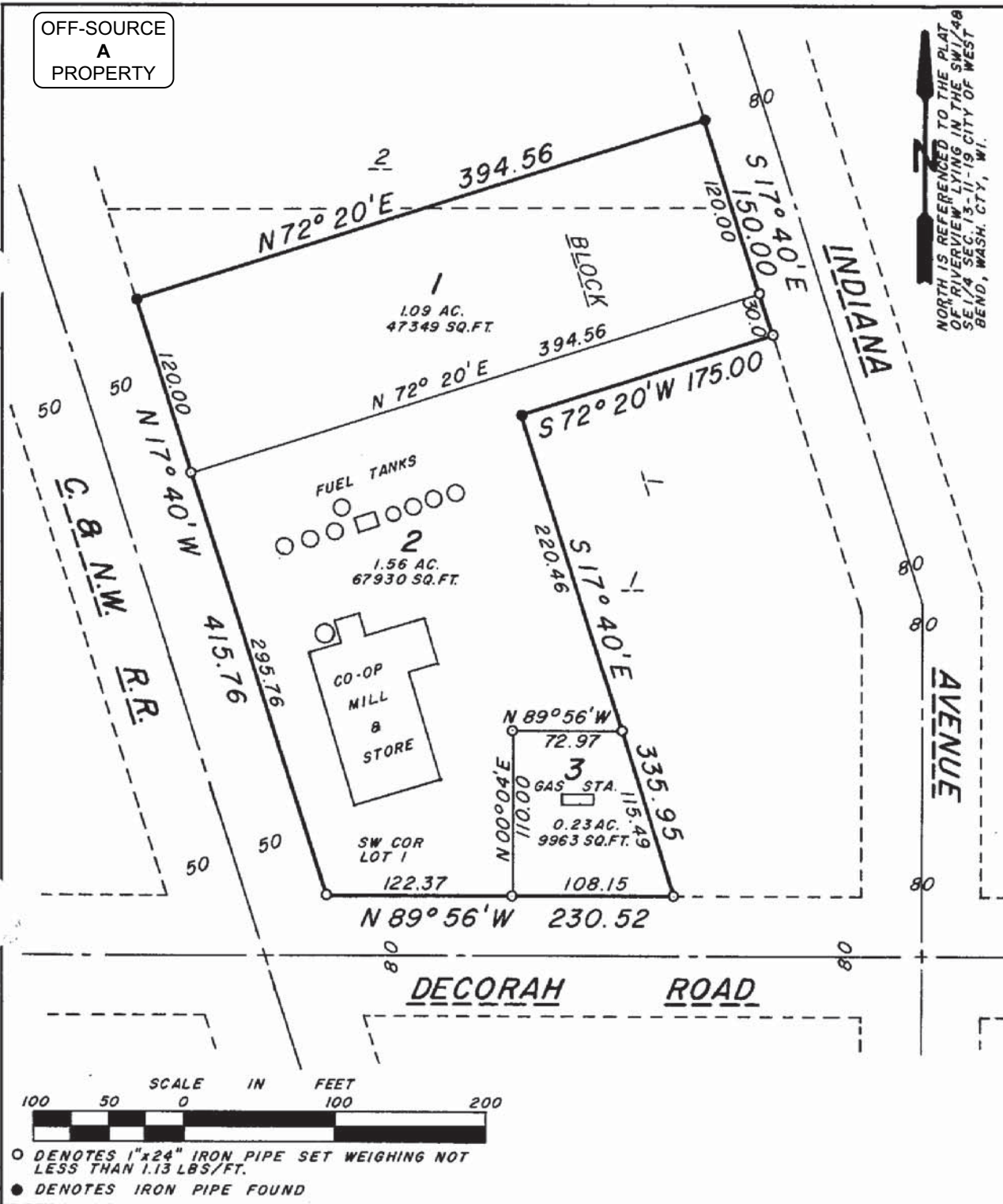

NORTH IS REFERENCED TO THE PLAT OF "RIVERVIEW" LYING IN THE SW 1/4 SEC. 13-11-19 CITY OF WEST BEND, WASH. CTY., WI.



OFF-SOURCE
A
PROPERTY

457817

RECORDED

CERTIFIED SURVEY MAP

Number 2570 Volume 14 Page 72

Certified Survey Maps of Washington County

Aug 23 9 22 AM '83

John H. Steiner
 CLERK OF DISTRICT
 OF WASHINGTON COUNTY, WA

City of West Bend Approval

Resolution No. 23, 1983 - 1984 Council
 Resolved by the Common Council of the City of West Bend,
 that this Certified Survey Map is hereby approved.

Dated this 16th day of August, 1983.

Dennis W. Oberlin

City Clerk

Donald Z. Goring

Mayor

Approval of City Engineer

Approved as being in conformance with all ordinances,
 rules, regulations and plans of the City of West Bend.

Dated this 19th day of August, 1983.

Mark E. [Signature]

City Engineer

OFF-SOURCE
A
PROPERTY

Information
for Parcel



1119.133.0020, Tax Year 2013

Property Information

Tax Year 2013	Parcel Number 1119.133.0020
Tax Status Taxable	Property Class B-B-Commercial
Tax Code TC1 - Tax Code #1	Neighborhood 710 - 710
Site Address 760 INDIANA AV	Legal Description RIVERVIEW HEIGHTS BLOCK 1, PT OF LOT 1 AND THE SLY 10 FT OF LOT 1 CSM #2570 ALL OF LOTS 2 & 3 CSM#2570 DOC #1074323
Owner Name and Address JKA ENTERPRISES LLC JOEL LEDERHAUSE 1470 PAMME CT WEST BEND, WI 53090-0000	Mailing Name and Address JKA ENTERPRISES LLC JOEL LEDERHAUSE 1470 PAMME CT WEST BEND, WI 53090-0000

Assessments

Assessment Period	Land	Building	Total
Prior Year Value	279,600	1,385,300	1,664,900

Sales History

Year	Document #	Sale Type	Sale Date	Sold To	Sold By	Price
2004	1074323	Land and Improvement	12/01/2004			\$650,000

Zoning

Classification General Industrial District	Special Use? No
--	---------------------------

Permits

Permit #	Type	Application Date	Description	Construction Value
----------	------	------------------	-------------	--------------------

Structures (1 of 2)

Style	Property Use	Total Living Area (sq. ft.)	Above Grade (sq. ft.)	Year Built	Age
2ND FLOOR					
	Commercial	0	39,826	1970	
	Distribution Warehouse	100.00			4200.00
	Concrete Block	4200.00			4200.00
RAMPS UNLIMITED - 1ST FLOOR					
	Distribution Warehouse	100.00			35626.00
	Concrete Block	35626.00			4275.00

Structures (2 of 2)

Style	Property Use	Total Living Area (sq. ft.)	Above Grade (sq. ft.)	Year Built	Age
RAMPS UNLIMITED - WAREHOUSE					
	Storage Warehouse	100.00			24700.00
	Exterior Walls	24700.00			24700.00

OFF-SOURCE
A
PROPERTY

1119 133
-0021

CSM # 2570
LOT 1

10.00

S INDIANA AVE

1125
1126
1127
1128
1129
1130
1131
1132
1133
1134
1135
1136
1137
1138
1139
1140
1141
1142
1143
1144
1145
1146
1147
1148
1149
1150
1151
1152
1153
1154
1155
1156
1157
1158
1159
1160
1161
1162
1163
1164
1165
1166
1167
1168
1169
1170
1171
1172
1173
1174
1175
1176
1177
1178
1179
1180
1181
1182
1183
1184
1185
1186
1187
1188
1189
1190
1191
1192
1193
1194
1195
1196
1197
1198
1199
1200
1201
1202
1203
1204
1205
1206
1207
1208
1209
1210
1211
1212
1213
1214
1215
1216
1217
1218
1219
1220
1221
1222
1223
1224
1225
1226
1227
1228
1229
1230
1231
1232
1233
1234
1235
1236
1237
1238
1239
1240
1241
1242
1243
1244
1245
1246
1247
1248
1249
1250

394.56
394.56

175.00

30.00

1193.76

760

1119013
-0045

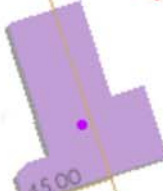

1119 133
-0020

CSM # 2570
LOT 2

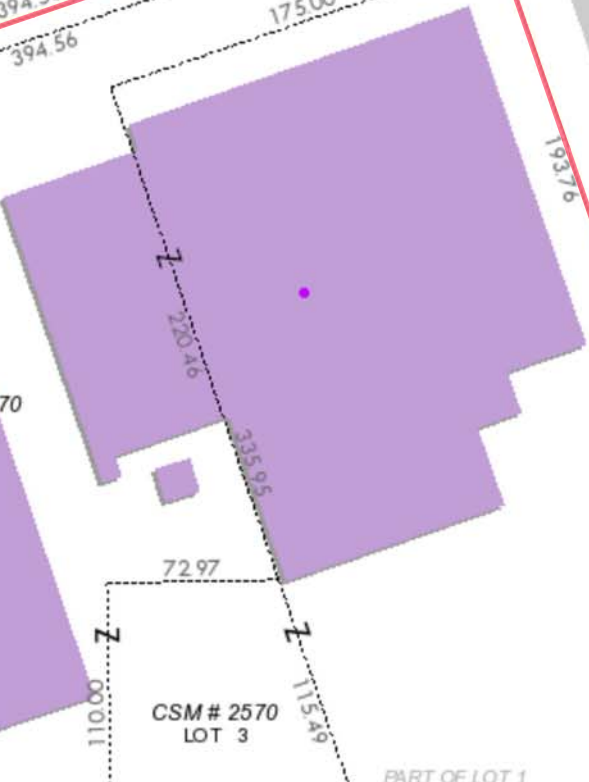

295.76

220.46

335.95

CSM # 2570
LOT 3

72.97

115.49

PART OF LOT 1

122.37

108.15

123.36

108
57.74

106
102

115
146.81

103

111

111A

SAND DR

80'

40'

40'

80'

40'

40'

40'

40'

40'

40'

40'

40'

40'

Map Generated from GIS



December 12, 2012

Project Reference #6662

Mr. Jim Sievert
Good Shepherd Evangelical Lutheran Church
777 S. Indiana Avenue
West Bend, WI 53095

Certified Mail

**Subject: Notice of Residual Petroleum Hydrocarbon Groundwater Impacts
777 S. Indiana Avenue, West Bend, Wisconsin**

Dear Mr. Sievert:

This letter is in regard to the investigation of a petroleum hydrocarbon release at 111 E. Decorah Road, West Bend, Wisconsin which has shown to have migrated onto your property referenced above. Jacobus Energy, Inc. (Jacobus) has conducted site investigation and remediation activities and will be requesting that the Wisconsin Department of Natural Resources (WDNR) grant case closure. Case closure means that the WDNR will not be requiring any further investigation or cleanup action to be taken. In conjunction with Sigma Environmental Services, Inc.'s (Sigma's) evaluation of the project, Jacobus is proposing that natural attenuation be relied upon for the 111 E. Decorah Road property and the 777 S. Indiana Avenue property as a means to further reduce residual groundwater impacts over time.

The WDNR will not review the closure request for at least 30 days after the date of this letter. As an affected property owner, you have a right to contact the WDNR to provide any technical information that you may have that indicates that closure should not be granted for this site. If you would like to submit any information to the WDNR that is relevant to this closure request, you should mail that information to: Mr. John Feeny, WDNR Plymouth Service Center, Remediation & Redevelopment Program, 1155 Pilgrim Road, Plymouth, WI 53073.

Please review the enclosed legal description of your property and notify Adam Roder of Sigma within the next 30 days if the legal description is incorrect.

If closure for this site is approved by the WDNR, the following are some continuing obligations for which you will be responsible. WDNR publication PUB-RR-819 ("Continuing Obligations for Environmental Protection, Responsibilities of Wisconsin Property Owners") is included with this letter. If needed, a copy of this fact sheet can also be downloaded from the WDNR website.

- Groundwater contamination that appears to have originated on the 111 E. Decorah Road property has migrated onto your 777 S. Indiana Avenue property as shown in the attached Groundwater Quality Map. The levels of petroleum volatile organic compounds (PVOCs) and naphthalene in groundwater at your property are above

the NR 140 Enforcement Standards (ESs). If you intend to construct a new well, or reconstruct an existing well, you will need prior WDNR approval.

- The dissolved PVOC plume in groundwater is stable or receding and will degrade over time. Natural attenuation processes will continue to clean up the residual subsurface impacts such that the requirements for regulatory case closure found in NR 726 and NR 746 will be met; the WDNR will be requested to accept natural attenuation as a final remedy for this site and grant case closure. WDNR publication PUB-RR-619 ("Using Natural Attenuation to Clean Up Contaminated Groundwater: What Landowners Should Know") is included with this letter. If needed, a copy of this fact sheet can also be downloaded from the WDNR website.
- While vapors are not of concern at this time, they may pose a health issue if buildings are constructed on your property in the future. If you intend to construct a building to be occupied in the vicinity of the residual impacts, you will first need to notify the WDNR. Vapor mitigation technologies may be required for construction of occupied buildings unless the vapor migration pathway is shown to not be a risk for such construction.

After the WDNR makes a decision on the closure request, it will be documented in a letter. If the WDNR grants closure, you will receive a copy of the closure letter. If needed, you may also obtain a copy of the closure letter by requesting a copy from Jacobus or Sigma, by writing to the WDNR address given above, or by accessing the WDNR Geographic Information System (GIS) Registry (via RR Sites Map) on the internet at <http://dnr.wi.gov/topic/Brownfields/clean.html>. The closure letter will be included as part of the file attached on the GIS Registry.

If this case is closed, all properties within the site boundaries where soil and/or groundwater contamination exceeds NR 720 generic Residual Contaminant Levels and/or NR 140 ESs, respectively, will be listed on the WDNR's GIS Registry of Closed Remediation Sites. The information on the GIS Registry includes maps showing the location of properties in Wisconsin where soil and/or groundwater impacts above applicable standards were present at the time that the case was closed. The GIS Registry will be available to the general public on the WDNR's internet web site.

Should you or any subsequent property owner wish to construct or reconstruct a well on your property, special well construction standards may be necessary to protect the well from the residual contamination. Any well driller who proposes to construct a well on your property in the future will first need to obtain approval from a regional water supply specialist in DNR's Drinking Water and Groundwater Program. The well construction application, form 3300-254, is on the internet at <http://dnr.wi.gov/topic/wells/documents/3300254.pdf>.

Finally, WDNR publication PUB-RR-589 ("When Contamination Crosses a Property Line - Rights and Responsibilities of Property Owners" is included with this letter to help further explain you rights and responsibilities as an affected property owner. If needed, a copy of this fact sheet can also be downloaded from the WDNR website.

Good Shepherd Evangelical Lutheran Church
December 12, 2012

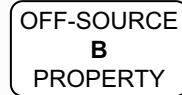

Page 3

If you need more information, you may contact Mike Helgesen of Jacobus (11815 W. Bradley Road, Milwaukee, WI 53224; phone number 414-577-0217) or Adam Roder of Sigma (1300 W. Canal Street, Milwaukee, WI 53233; phone number 414-643-4200).

Sincerely,

SIGMA ENVIRONMENTAL SERVICES, INC.

A handwritten signature in blue ink that reads "Adam J. Roder".

Adam J. Roder, P.E.
Senior Engineer

Enclosures:

Deed & Legal Description Information
Groundwater Quality Map
PUB-RR-819
PUB-RR-671
PUB-RR-589

cc: Mr. Mike Helgesen - Jacobus Energy, Inc.

OFF-SOURCE
B
PROPERTY

UNITED STATES POSTAL SERVICE



First-Class Mail
Postage & Fees Paid
USPS
Permit No. G-10

• Sender: Please print your name, address, and ZIP+4 in this box •

THE SIGMA GROUP
1300 W. Canal Street
Milwaukee, WI 53233

JACOBUS 662-002 AJR



SENDER: COMPLETE THIS SECTION

- Complete items 1, 2, and 3. Also complete item 4 if Restricted Delivery is desired.
- Print your name and address on the reverse so that we can return the card to you.
- Attach this card to the back of the mailpiece, or on the front if space permits.

1. Article Addressed to:

J Sievert
Good Shepherd Eu
Lutheran Church
777 S Indiana Ave
West Bend, WI 53095

2. Article Number

(Transfer from service label)

7010 0780 0001 3301 1664

PS Form 3811, August 2001

Domestic Return Receipt

2ACPRI-03-P-4081

COMPLETE THIS SECTION ON DELIVERY

A. Signature

J Sievert

Agent

Addressee

B. Received by (Printed Name)

C. Date of Delivery

D. Is delivery address different from item 1? Yes
If YES, enter delivery address below: No

3. Service Type

Certified Mail Express Mail

Registered Return Receipt for Merchandise

Insured Mail C.O.D.

4. Restricted Delivery? (Extra Fee)

Yes

OFF-SOURCE
B
PROPERTY

State Bar of Wisconsin Form 3-2003
QUIT CLAIM DEED

DOC# 1134213

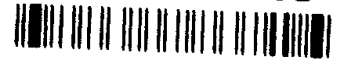

Recorded
JULY 27, 2006 AT 10:45AM
SHARON A MARTIN, REGISTER OF DEEDS
WASHINGTON COUNTY, WISCONSIN

Fee Amount: \$13.00
Fee Exempt 77.25-(6M)

Document Number

Document Name

THIS DEED, made between Good Shepherd Evangelical Lutheran Church

("Grantor," whether one or more), and Good Shepherd Evangelical Lutheran Church Properties, Ltd.

("Grantee," whether one or more).

Grantor quit claims to Grantee the following described real estate, together with the rents, profits, fixtures and other appurtenant interests, in Washington

County, State of Wisconsin ("Property") (if more space is needed, please attach addendum):

See attached Addendum A.

This deed is subject to the mortgages given to National Exchange Bank & Trust pertaining to Parcel 1 and Parcel 3 only, specifically Doc. #1046699 recorded 5/3/04 and Doc. #1053661 recorded 6/22/04, of which Grantee assumes all responsibilities for those obligations.

THIS TRANSACTION IS EXEMPT FROM FEE PURSUANT TO WIS. STAT. SEC. 77.25(6m).

Recording Area

Name and Return Address
Atty. James E. Aschenbrener
P.O. Box 52
Jackson, WI 53037

132

See attached

Parcel Identification Number (PIN)

This is not homestead property.
~~(is)~~ (is not)

Dated July 27,

[Signature] (SEAL)
* Mark J. Frank, President

2006.
[Signature] (SEAL)
* Mark A. Mey, Secretary

* _____ (SEAL)

* _____ (SEAL)

AUTHENTICATION

Signature(s) _____

authenticated on _____

TITLE: MEMBER STATE BAR OF WISCONSIN
(If not, _____
authorized by Wis. Stat. § 706.06)

THIS INSTRUMENT DRAFTED BY:
Atty. James E. Aschenbrener, as scrivener
SBN 1008896

ACKNOWLEDGMENT

STATE OF WISCONSIN

WASHINGTON COUNTY

Personally came before me on July 27, 2006
the above-named Mark J. Frank, President, and Mark A. Mey,
Secretary,

to me known to be the person(s) who executed the foregoing instrument and acknowledged the same.

[Signature]
JAMES E. ASCHENBRENER

Notary Public, State of Wisconsin

My commission (is permanent) (expires) _____

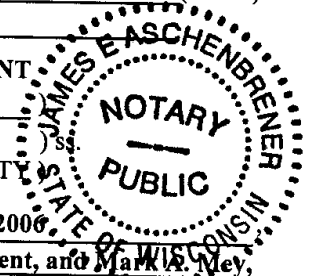

(Signatures may be authenticated or acknowledged. Both are not necessary.)

NOTE: THIS IS A STANDARD FORM. ANY MODIFICATION TO THIS FORM SHOULD BE CLEARLY IDENTIFIED.

QUIT CLAIM DEED

©2003 STATE BAR OF WISCONSIN

FORM NO. 3-2003

*Type name below signatures.

ADDENDUM A
TO
QUIT CLAIM DEED

Grantor: Good Shepherd Evangelical Lutheran Church
Grantee: Good Shepherd Evangelical Lutheran Church Properties, Ltd.

Legal Description and Tax Parcel No's:

PARCEL 1:

Lots One (1), Two (2), Three (3), Four (4), Five (5), Six (6), Seven (7), Eight (8), Eleven (11), Twelve (12), Thirteen (13), Twenty-eight (28), Twenty-nine (29), Thirty (30), Thirty-one (31), Thirty-two (32), Thirty-three (33), Thirty-four (34), Thirty-five (35), Thirty-six (36), Thirty-seven (37) and Thirty-eight (38) of Block Four (4), together with that portion described as vacated Pennsylvania Place lying adjacent to Parcels, as set forth in Ordinance No. 472, passed and approved on June 9, 1952, in Riverview Heights, a Subdivision at West Bend, Wisconsin, lying in the SW ¼ and the SE ¼ of Sec. 13, T-11-N, R-19-E, in the City of West Bend and the Township of West Bend, Washington County, Wisconsin.

Tax Parcel No. 1119 133 0633
Property Address: 773 Indiana Avenue

PARCEL 2:

Lot Fourteen (14) of Block Four (4) in RIVERVIEW HEIGHTS, a Subdivision at West Bend – Wisconsin lying in the SW ¼ and the SE ¼ of Sec. 13, T. 11 N., R. 19 E., in the City of West Bend, and the Township of West Bend, Washington County, Wisconsin.

Tax Parcel No. 1119 133 0635
Property Address: 768 Eastern Avenue

PARCEL 3:

Lot One (1) of Certified Survey Map No. 5701, recorded in the Washington County Registry on February 20, 2004 in Volume 41 of Certified Survey Maps, pages 243-245 as Document No. 1037260, being a conjoining of Parcels 1 and 2 of Certified Survey Map No. 4010 recorded in the Washington County Registry on January 6, 1993 in Volume 25 of Certified Survey Maps on pages 320-322, as Document No. 622174 being part of the Northeast ¼ of the Northwest ¼ of Section 24, Town 11 North, Range 19 East, City of West Bend, Washington County, Wisconsin.

Tax Parcel No. 1119 242 0031
Property Address: 325 E. Decorah Road

OFF-SOURCE
B
PROPERTY



Information for Parcel 1119.133.0706, Tax Year 2013

Property Information	
Tax Year 2013	Parcel Number 1119.133.0706
Tax Status Exempt	Property Class E1-Exempt - All Others
Tax Code TC1 - Tax Code #1	Neighborhood 008 - 008 Riverview Park Exempt
Site Address 773 INDIANA AV	Legal Description RIVERVIEW HEIGHTS BLOCK 4, LOTS 1 THRU 8 AND LOTS 28 THRU 38
Owner Name and Address GOOD SHEPHERD EVANGELICAL LUTHERAN CHURCH OF WEST BEND 777 INDIANA AV WEST BEND, WI 53095-0000	Mailing Name and Address GOOD SHEPHERD EVANGELICAL LUTHERAN CHURCH OF WEST BEND 777 INDIANA AV WEST BEND, WI 53095-0000

Assessments			
Assessment Period	Land	Building	Total

Sales History						
Year	Document #	Sale Type	Sale Date	Sold To	Sold By	Price

Zoning	
Classification Institutional	Special Use? No

Permits				
Permit #	Type	Application Date	Description	Construction Value
201100047	REROOFING			\$35,700.00

Images
No images found.

OFF-SOURCE
B
PROPERTY

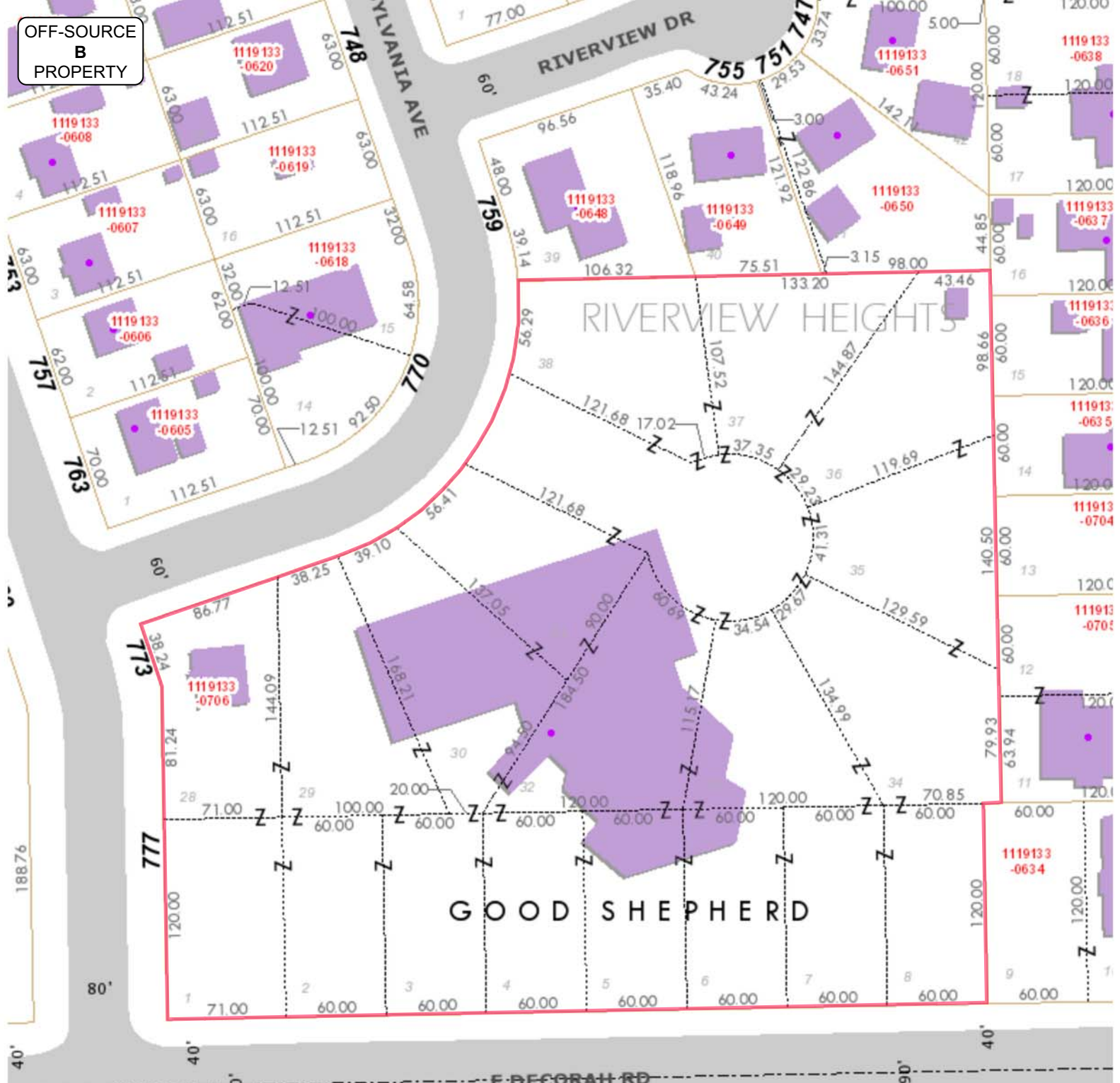

Map Generated from GIS



December 12, 2012

Project Reference #6662

Ms. Judith Neu, P.E.
City Engineer
City of West Bend
1115 S. Main Street
West Bend, WI 53095

Certified Mail

**Subject: Notice of Residual Petroleum Hydrocarbon Soil and Groundwater Impacts
111 E. Decorah Road Right-of-Way, West Bend, Wisconsin**

Dear Ms. Neu:

This letter is in regard to the investigation of a petroleum hydrocarbon release at 111 E. Decorah Road, West Bend, Wisconsin which has shown to have migrated onto the road right-of-way referenced above. Jacobus Energy, Inc. (Jacobus) has conducted site investigation and remediation activities and will be requesting that the Wisconsin Department of Natural Resources (WDNR) grant case closure. Case closure means that the WDNR will not be requiring any further investigation or cleanup action to be taken. In conjunction with Sigma Environmental Services, Inc.'s (Sigma's) evaluation of the project, Jacobus is proposing that natural attenuation be relied upon for the 111 E. Decorah Road property and the E. Decorah Road right-of-way as a means to further reduce residual soil and groundwater impacts over time.

The WDNR will not review the closure request for at least 30 days after the date of this letter. As an affected property owner, you have a right to contact the WDNR to provide any technical information that you may have that indicates that closure should not be granted for this site. If you would like to submit any information to the WDNR that is relevant to this closure request, you should mail that information to: Mr. John Feeney, WDNR Plymouth Service Center, Remediation & Redevelopment Program, 1155 Pilgrim Road, Plymouth, WI 53073.

If closure for this site is approved by the WDNR, the following are some continuing obligations for which you will be responsible. WDNR publication PUB-RR-819 ("Continuing Obligations for Environmental Protection, Responsibilities of Wisconsin Property Owners") is included with this letter. If needed, a copy of this fact sheet can also be downloaded from the WDNR website.

- Groundwater contamination that appears to have originated on the 111 E. Decorah Road property has migrated onto the E. Decorah Road right-of-way as shown in the attached Groundwater Quality Map. The levels of petroleum volatile organic compounds (PVOCs) and naphthalene in groundwater at your property are above the NR 140 Enforcement Standards (ESs).

- The dissolved PVOC plume in groundwater is stable or receding and will degrade over time. Natural attenuation processes will continue to clean up the residual subsurface impacts such that the requirements for regulatory case closure found in NR 726 and NR 746 will be met; the WDNR will be requested to accept natural attenuation as a final remedy for this site and grant case closure. WDNR publication PUB-RR-619 ("Using Natural Attenuation to Clean Up Contaminated Groundwater: What Landowners Should Know") is included with this letter. If needed, a copy of this fact sheet can also be downloaded from the WDNR website.
- Soil contamination remains beneath the E. Decorah Road right-of-way (below the sewer, water, and other known utility inverts) as shown in the attached Soil Quality Map. If impacted soil is excavated in the future, the property owner at the time of excavation must sample and analyze the excavated soil to determine if residual contamination remains and whether the material would be considered solid or hazardous waste. Any storage, treatment, and/or disposal must be performed in compliance with applicable statutes and rules. Special precautions may be necessary during excavation activities to mitigate potential health risks during such work.

After the WDNR makes a decision on the closure request, it will be documented in a letter. If the WDNR grants closure, you will receive a copy of the closure letter. If needed, you may also obtain a copy of the closure letter by requesting a copy from Jacobus or Sigma, by writing to the WDNR address given above, or by accessing the WDNR Geographic Information System (GIS) Registry (via RR Sites Map) on the internet at <http://dnr.wi.gov/topic/Brownfields/clean.html>. The closure letter will be included as part of the file attached on the GIS Registry.

If this case is closed, all properties within the site boundaries where soil and/or groundwater contamination exceeds NR 720 generic RCLs and/or NR 140 ESs, respectively, will be listed on the WDNR's GIS Registry of Closed Remediation Sites. The information on the GIS Registry includes maps showing the location of properties in Wisconsin where soil and/or groundwater impacts above applicable standards were present at the time that the case was closed. The GIS Registry will be available to the general public on the WDNR's internet web site.

Should you or any subsequent property owner wish to construct or reconstruct a well on your property, special well construction standards may be necessary to protect the well from the residual contamination. Any well driller who proposes to construct a well on your property in the future will first need to obtain approval from a regional water supply specialist in DNR's Drinking Water and Groundwater Program. The well construction application, form 3300-254, is on the internet at <http://dnr.wi.gov/topic/wells/documents/3300254.pdf>.

Finally, WDNR publication PUB-RR-589 ("When Contamination Crosses a Property Line - Rights and Responsibilities of Property Owners" is included with this letter to help further explain you rights and responsibilities as an affected property owner. If needed, a copy of this fact sheet can also be downloaded from the WDNR website.

City of West Bend
December 12, 2012

RIGHT-OF-WAY

Page 3

If you need more information, you may contact Mike Helgesen of Jacobus (11815 W. Bradley Road, Milwaukee, WI 53224; phone number 414-577-0217) or Adam Roder of Sigma (1300 W. Canal Street, Milwaukee, WI 53233; phone number 414-643-4200).

Sincerely,

SIGMA ENVIRONMENTAL SERVICES, INC.



Adam J. Roder, P.E.
Senior Engineer

Enclosures:

Groundwater Quality Map
Soil Quality Map
PUB-RR-819
PUB-RR-671
PUB-RR-589

cc: Mr. Mike Helgesen - Jacobus Energy, Inc.

UNITED STATES POSTAL SERVICE

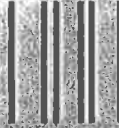

First-Class Mail
Postage & Fees Paid
USPS
Permit No. G-10

• Sender: Please print your name, address, and ZIP+4 in this box •

THE SIGMA GROUP
1300 W. Canal Street
Milwaukee, WI 53233

JACOBUS 6662-003 AJR



SENDER: COMPLETE THIS SECTION

- Complete items 1, 2, and 3. Also complete item 4 if Restricted Delivery is desired.
- Print your name and address on the reverse so that we can return the card to you.
- Attach this card to the back of the mailpiece, or on the front if space permits.

1. Article Addressed to:

J Neu
City of West Bend
1115 S Main ST
West Bend, WI
53095

2. Article Number
(Transfer from service label)

7010 0780 0001 3301 1657

COMPLETE THIS SECTION ON DELIVERY

A. Signature
 Linda Kreiter Agent
 Addressee

B. Received by (Printed Name) *Linda Kreiter* C. Date of Delivery *12/14/12*

D. Is delivery address different from item 1? Yes
if YES, enter delivery address below: No

3. Service Type
 Certified Mail Express Mail
 Registered Return Receipt for Merchandise
 Insured Mail C.O.D.

4. Restricted Delivery? (Extra Fee) Yes