

Thompson, Matthew A - DNR

From: Thompson, Matthew A - DNR
Sent: Wednesday, January 16, 2019 8:57 AM
To: Tom Kilian
Subject: BRRTS #02-37-000006 Wauleco: NR714.05(5) Information
Attachments: 2019-01.15_W40 VI Soil Gas Investigation Work Plan.pdf; 0237000006_20190115_99_aerial_deposition_SI_req_292.31_req_ltr.pdf

Tom- Per your NR714.05(5) request for site or facility specific response attached is a copy of the soil gas investigation work plan and the DNR's request that Wauleco provide solid and hazardous waste records to the RR program by March 16th, 2019. This request also includes a request to prepare a scope of work to investigate contamination as a result of burning waste at the facility.

Feel free to contact me with questions,
Matt

We are committed to service excellence.

Visit our survey at <http://dnr.wi.gov/customersurvey> to evaluate how I did.

Matt Thompson

Hydrogeologist – Remediation and Redevelopment
Wisconsin Department of Natural Resources
1300 W. Clairemont Ave., Eau Claire, WI 54701
Office: 715-839-3750
matthewa.thompson@wisconsin.gov



From: Iverson, Bruce <B Iverson@trcsolutions.com>
Sent: Tuesday, January 15, 2019 10:11 AM
To: DNR RR WCR <DNRRRWCR@wisconsin.gov>; Thompson, Matthew A - DNR <MatthewA.Thompson@wisconsin.gov>
Subject: BRRTS #02-37-000006 Wauleco: Supplemental Soil Gas Investigation Work Plan at Well W40

On behalf of Wauleco, Inc. (Wauleco), Matt per your request, attached is the Work Plan for the supplemental soil gas investigation activities in the area of well W40 for the Wauleco project site located in Wausau, WI. A paper copy has also been sent. If you have any questions, please contact me. Thanks, Bruce

Bruce Iverson, P.E. (WI)
Senior Project Manager



708 Heartland Trail, Suite 3000, Madison, WI 53717
T: 608.826.3644 | F: 608.826.3941 | C: 608.235.4963

[LinkedIn](#) | [Twitter](#) | [Blog](#) | www.trcsolutions.com

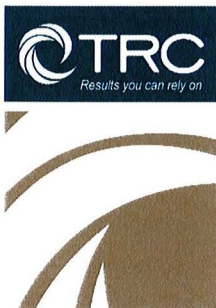

708 Heartland Trail
Suite 3000
Madison, WI 53717

608-826-3600 PHONE
608-826-3941 FAX

www.TRCSolutions.com

January 15, 2019

Mr. Matt Thompson
Wisconsin Department of Natural Resources
1300 W. Clairemont Avenue
Eau Claire, WI 54701

Subject: Supplemental Vapor Intrusion Assessment- Soil Gas Investigation Work Plan at Well W40
Wauleco, Inc., Wausau, Wisconsin
BRRTS #02-37-000006

Dear Mr. Thompson:

On behalf of Wauleco, Inc., (Wauleco), TRC Environmental Corporation (TRC) is submitting a Soil Gas Investigation Work Plan for the Wauleco site in Wausau, Wisconsin.

Background

In June 2012, TRC provided the Wisconsin Department of Natural Resources (WDNR) with a Vapor Intrusion Risk Screening Level Assessment¹ (VI Assessment), which found that there were no potentially complete vapor intrusion pathways associated with the Wauleco site, based on the site conditions present at that time.

Since the VI Assessment was submitted, free product² has been sporadically observed in off-site monitoring well W40 on a few occasions (see Figure 1). Based on this site condition, the WDNR requested an update to the VI Assessment.

This light non-aqueous phase liquid (LNAPL) is a mixture of pentachlorophenol (PCP) and mineral spirits. The PCP is not sufficiently volatile to be a vapor risk; however, the mineral spirits contain petroleum hydrocarbons, which have the potential to pose a vapor risk if certain conditions are met.

The WDNR's current vapor intrusion guidance³ recommends additional assessment to assess the vapor intrusion pathway when free product containing petroleum hydrocarbons

¹ TRC. 2012. Vapor Intrusion Risk Screening Level Assessment. Wauleco, Inc. 125 Rosecrans Street, Wauleco, Wisconsin. June 14, 2012.

² Free Product – the term used in the 2018 WDNR vapor intrusion guidance document for mobile light non-aqueous phase liquid (LNAPL).

³ WDNR, 2018. Addressing Vapor Intrusion at Remediation and Redevelopment Sites in Wisconsin. RR-800. January 2018.

is present within 15 feet (vertically) of a building foundation. The LNAPL observed in W40 is approximately 19 feet below ground surface (bgs), and assuming a basement foundation is typically 6 to 8 feet bgs, then the free product observed in W40 is potentially within 15 feet of the foundation of nearby buildings. Therefore, additional assessment is needed to rule out the vapor intrusion pathway near this location.

Petroleum Vapor Intrusion Assessment

Petroleum Vapor Screening Criteria

Vapors from petroleum hydrocarbons can easily and rapidly degrade in an aerobic environment and, once degraded, no longer pose a risk for vapor intrusion. This is clearly illustrated in Figure 3b of the WDNR 2018 vapor intrusion guidance document that includes indicators of aerated soil conditions (i.e., oxygen >5%, methane <1%, and lower explosive limit (LEL) <10%). As such, the petroleum vapor intrusion risk can be ruled out when aerobic soil gas conditions are present in the zone between the source of vapors and a building's foundation.

Preliminary Assessment

On November 16, 2018, as an initial step to update the VI Assessment, TRC completed a preliminary assessment of the soil gas conditions at monitoring well W40. For this assessment, TRC sealed well W40 with a packer set 14 feet bgs. This depth is 0.5 feet above the top to the well screen and approximately 4 to 5 feet above the water table. The headspace is connected to the well filter pack and vadose zone (Attachment A).

TRC purged and collected gas samples from the headspace in this packed off zone using a low flow vacuum pump. The gas samples were field analyzed for oxygen (O₂), methane (CH₄), carbon dioxide (CO₂), and lower explosive limit (LEL) using a LandTec 2000 Soil Gas Analyzer (LandTec). The samples had low levels of CO₂, CH₄, and LEL, and O₂ levels greater than 21%, summarized as follows, as previously provided to the WDNR:

PARAMETER	RESULT AT W40	INDICATOR OF AERATED SOIL
Oxygen (O ₂)	22%	Greater Than 5%
Methane (CH ₄)	0.1%	Less Than 1.0%
Lower Explosive Limit (LEL)	2%	Less Than 10%
Carbon Dioxide (CO ₂)	0%	Low levels

These results indicate that aerobic conditions are present in the soil gas near W40 in that they meet WDNR's standards for aerobic conditions.



Mr. Matt Thompson
Wisconsin Department of Natural Resources
January 15, 2019
Page 3

Soil Gas Sampling

To confirm the results from the preliminary assessment, and as an additional step to update the VI Assessment, TRC will install two soil gas probes in the right-of way near W40 (see Figure 1) at depths of approximately 16 feet bgs and 9 feet bgs using a Geoprobe®. These depths will target the zone approximately 3 feet above the water table (16 feet bgs) and the zone just below the depth of a typical basement (9 feet bgs). The water level in W40 will be measured prior to installing the soil gas probes to confirm the depth to groundwater.

The soil gas probes will be constructed with 6-inch well screens using the Single Depth High Integrity Sampling approach developed by Geoprobe® (Attachment B) and TRC's Standard Operating Procedure (SOP) ECR 015.

Key aspects of the sampling approach include the following:

- A filter pack will be set around the 6-inch soil gas probe and the annular space will be backfilled with bentonite to the surface. The bentonite will be allowed to hydrate to ensure a good seal from the surface and that the soil gas conditions measured in the probe are representative of conditions specific to that depth interval in the soil.
- An air-tight clamp will be kept on the sample tubing in the closed position at all times except for times of purging and sample collection.
- Prior to sample collection, approximately 1 well volume of air will be removed from each soil gas probe using a low flow vacuum pump. The volume of air to be removed will be calculated in the field based on the depth of construction for each probe.
- A LandTec gas meter will be connected to the tubing from the soil gas probe and connections will be leak-checked using a vacuum shut-in test.
- After verifying there are no leaks, the LandTec will be used to collect and analyze soil gas samples for O₂, CH₄, CO₂, and LEL.
- Following collection of the soil gas samples, the soil gas probe will be abandoned.

Schedule

The soil gas sampling for Wauleco is planned to occur this winter, likely in February 2019. Sampling in the winter, while the ground is still frozen, represents conservative (worst case) conditions with respect to assessing the aerobic conditions in soil gas because the subsurface has less connection to draw in oxygenated air from the atmosphere. Therefore, if aerobic conditions are confirmed at both depths in the vadose zone during winter sampling, this one sampling event will be used to rule out the potential for vapor intrusion at the Wauleco site.



Mr. Matt Thompson
Wisconsin Department of Natural Resources
January 15, 2019
Page 4

The results from the soil gas sampling will be provided to the WDNR in a letter documentation report.

If you have any questions or comments regarding this information, please call me at (608) 826-3644.

Sincerely,
TRC Environmental Corporation



Bruce Iverson
Project Manager

Attachments: Figure 1 – Proposed Location of Two Gas Probes
Attachment A – W40 Well Log
Attachment B – Geoprobe® Soil Gas Summary

cc: Evan Schreiner – Wauleco, Inc. (2 copies)
David Crass – Michael Best & Friedrich, LLP (1 copy)
Tom Dushek – TRC Wauleco (1 copy)
Alyssa Sellwood – TRC (1 copy)
Ken Quinn – TRC (1 copy)



Figure

11x17 -- USER: T:\p\trc -- ATTACHED REFS: JULY 2014 PCB BASE MAP, BaseMap -- ATTACHED IMAGES: --
 DRAWING NAME: J:\Wauleco\189597\0008\189597_0008_0003_01.dwg -- PLOT DATE: January 14, 2019 - 9:11AM -- LAYOUT: FIGURE 1
 Version: 2017-10-21

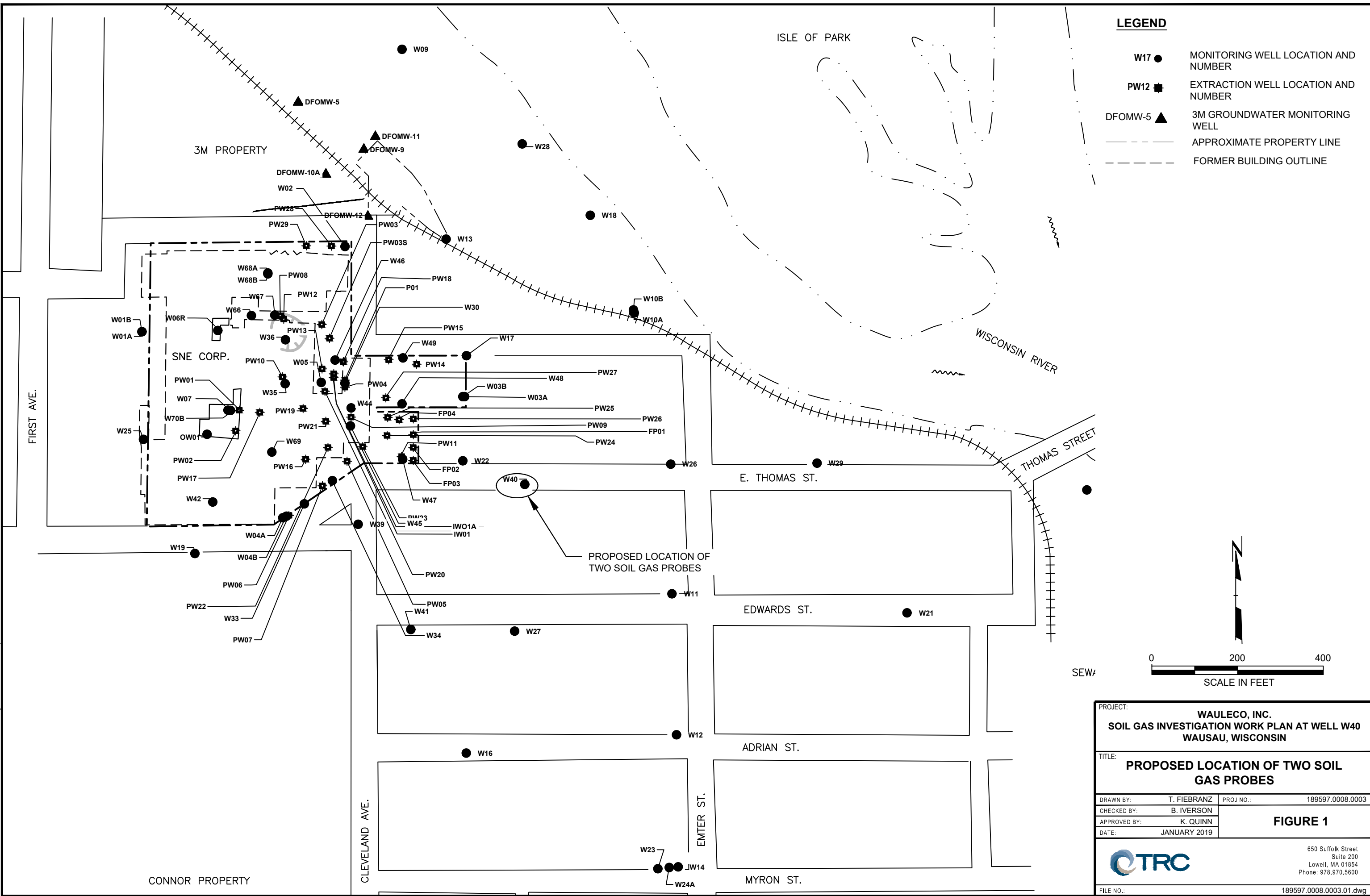

LEGEND

- W17 ● MONITORING WELL LOCATION AND NUMBER
- PW12 ■ EXTRACTION WELL LOCATION AND NUMBER
- DFOMW-5 ▲ 3M GROUNDWATER MONITORING WELL
- - - - - APPROXIMATE PROPERTY LINE
- - - - - FORMER BUILDING OUTLINE

 0 200 400
 SCALE IN FEET

PROJECT:		WAULECO, INC.	
		SOIL GAS INVESTIGATION WORK PLAN AT WELL W40	
		WAUSAU, WISCONSIN	
TITLE:			
PROPOSED LOCATION OF TWO SOIL GAS PROBES			
DRAWN BY:	T. FIEBRANZ	PROJ NO.:	189597.0008.0003
CHECKED BY:	B. IVERSON	FIGURE 1	
APPROVED BY:	K. QUINN		
DATE:	JANUARY 2019		
		650 Suffolk Street Suite 200 Lowell, MA 01854 Phone: 978.970.5600	
FILE NO.:		189597.0008.0003.01.dwg	

Attachment A

W40 Well Log

DRAFT





PROJECT: SNE LOCATION: WAUSAU, WI







DRILLING METHOD: 4.25" ID HOLLOW STEM AUGER GEOLOGIST: D. M. Smith
DRILLER: WTD, INC. DATE: May 11, 1990

Ground Elevation: _____
Top of Well Elev.: _____
Depth of Well: 29.5 ft.

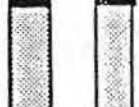
Sample Collection
G-grab T-shelby tube
S-splitspoon C-rock core

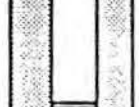
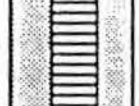
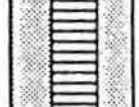
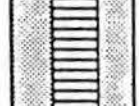
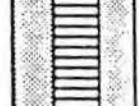
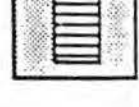
Casing Material: 2" PVC
Screen: 2" PVC (0.010 slot)

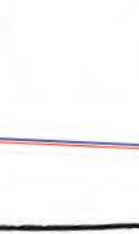
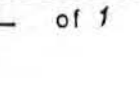
GRAVEL PACK  SCREEN 
BENTONITE  CAVE-IN 
GROUT 

Depth	Sample	SPT Blow Counts	Description	Construction
			NOTE: All information presented on this boring log resulted from field observations and thus reflects the subjective opinion of the field geologist.	
			Orange-brown well sorted fine SAND <i>SP</i>	
5	S	12 13 17	Orange-brown mc SAND, trace fmc gravel. <i>SP</i>	
			Orange-brown well sorted medium SAND, trace fm gravel. <i>SP</i>	
10	S	12 13 13	Multi-colored, well-sorted, medium SAND, trace fine gravel. <i>SP</i>	
			Multi-colored, fmc SAND, little fine gravel.	
15	S	45 62 49	@ 16 ft. 4 inches of black material (same texture) <i>SP</i> @ 16.5 ft. red-orange-brown mc SAND, little fmc gravel.	
20	S	44 37 23 33	Orange-brown fm SAND, little fm gravel, trace silt and clay. <i>SP</i>	
	S	47 37 15 24		
25	S	7 7 36 35	Multi-colored/orange-brown mc SAND, little fmc gravel. <i>SP</i>	
	S	52 23 19 22		
30			Bottom of boring at 30 feet	
35				
40				

Attachment B
Geoprobe® Soil Gas Summary

Direct Push Installation of Devices for Active Soil Gas Sampling & Monitoring

Technical Bulletin No. MK3098

Prepared: May, 2006

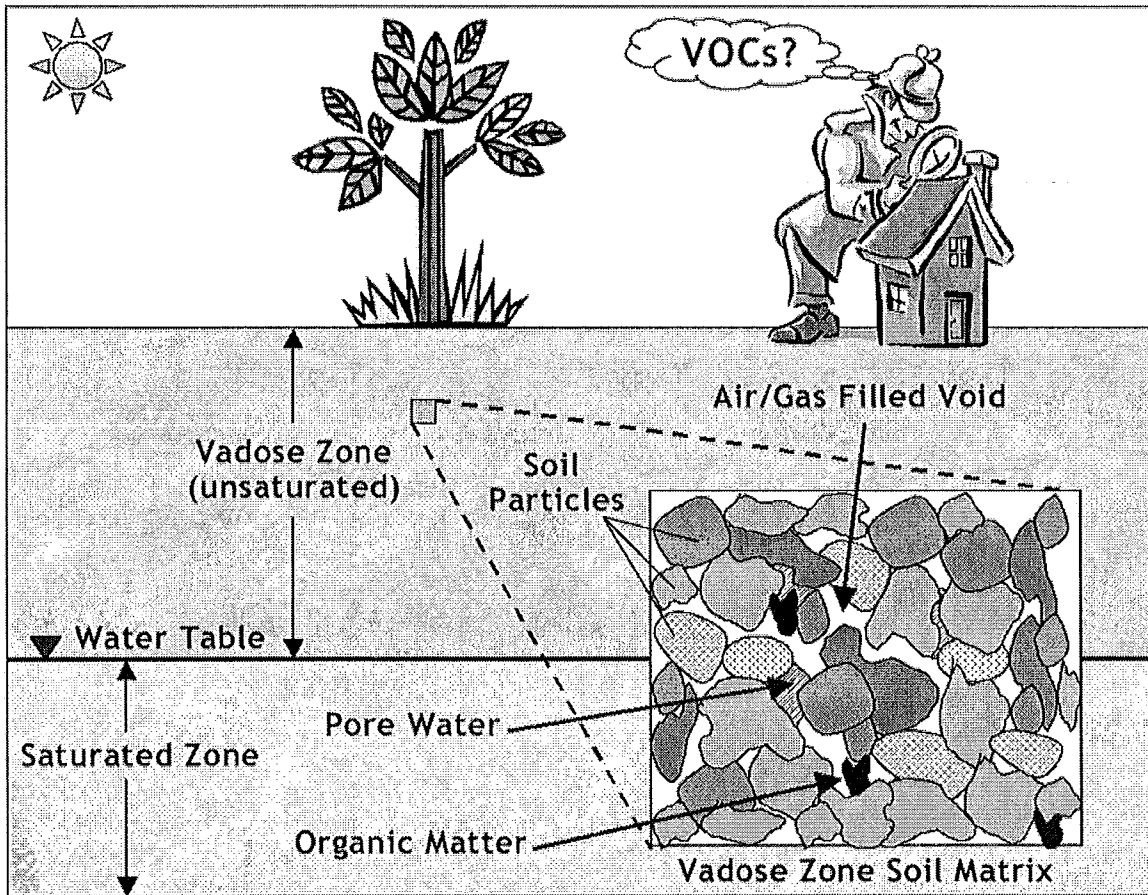

Section 7.0 Downhole Soil Gas Monitoring Methods for Evaluation of the Vapor Intrusion Pathway

Data obtained for evaluation of the vapor intrusion pathway (VIP) will generally be used to conduct a human health risk assessment (HHRA). Because the data will be used for a HHRA, the data quality objectives are very high and most of the soil gas sampling methods described in previous sections may not meet the sample quality requirements. To achieve the higher DQOs and to permit long-term monitoring of soil gas, most regulatory agencies are requiring the use of permanent soil gas monitoring wells or implants with filter media around the screens and high-integrity seals. In some situations, multilevel monitoring is required to define the vertical distribution of soil gas in the subsurface and evaluate the potential for contaminant degradation. The following sections outline some field methods that will enable the investigator to achieve the higher DQOs when either single-level or multilevel monitoring of soil gas is required.

7.1 Single-Depth High-Integrity Soil Gas Implants for Monitoring

If the installation of implants with smaller probe rods as described previously will not meet the higher DQOs for your project, the DT21 dual tube system may be required. This system uses 2.125-inch (54 mm) OD by 1.5-inch (38 mm) ID outer probe rods and 1-inch (25 mm) OD inner rods to provide access to the desired sampling interval either by use of a solid drive point or soil coring system (Figure 10, see also Technical Bulletin # 982100). To minimize compression of the formation and reduction of gas permeability, it is best to stop the DT21 system just above the interval where soil gas is to be sampled. The following steps (Figure 11) should be followed to install an implant for long-term soil gas monitoring:

- Once at the desired depth, the inner rod string and any soil sample is removed.
- A small thin-walled sample tube (P/N 19484) with drive head (P/N DT4055) is lowered through the outer rods and advanced ahead of the cutting shoe to remove a soil core where the implant will be installed (Figure 11). This sample tube (P/N 19484) is designed for low-density sands and finer-grained materials only.
- Once the soil core is removed a stiff brush (P/N BU600) may be lowered by extension rods (P/N AT671, etc.) into the open core hole in fine-grained or otherwise cohesive formations. The brush is rotated and moved up and down gently through the cored interval to relieve any smearing and reestablish natural gas flow into the void where the implant will be installed.
- The appropriate 6-inch (152 mm) or 12-inch (305 mm) long implant (Table 5) is attached to the selected tubing (Table 4) and lowered into the open core hole below the probe rods. Cap or cover the end of the tube at the surface to prevent clogging and/or loss of volatiles.
- Next, either environmental sand (P/N AT95) or fine glass beads (P/N AT93) are poured through the rod bore to fill the open hole around the implant screen. The probe rods should be retracted slowly to keep the filter media below the cutting shoe. Measure with suitable depth indicator to confirm the filter media extends at least 6 to 12 inches (152 to 305 mm) above the top of the implant.
- Grouting of the annulus may be accomplished in one of two ways.
 1. Fine bentonite chips (P/N AT91) are gravity poured through the rod bore as the rods are slowly retracted to keep chips below the cutting shoe. The chips are hydrated with water every 4- to 6-inch (102 to 152 mm) increment. Water should be added through a tube extending below the cutting shoe. This will prevent wetting the ID of the rods and possible bridging.
 2. A grout slurry of either bentonite powder (P/N AT92) or neat cement may be pumped by tremie tube using an appropriate grout machine to fill the bore hole as the drive rods are retracted.
- Once grouting is completed, suitable surface protection (P/N WP1771 or WP1741) should be installed to meet local needs and regulatory requirements. In remote locations such as landfills, a simple PVC pipe with slip-cap may provide suitable protection for short-term monitoring requirements.

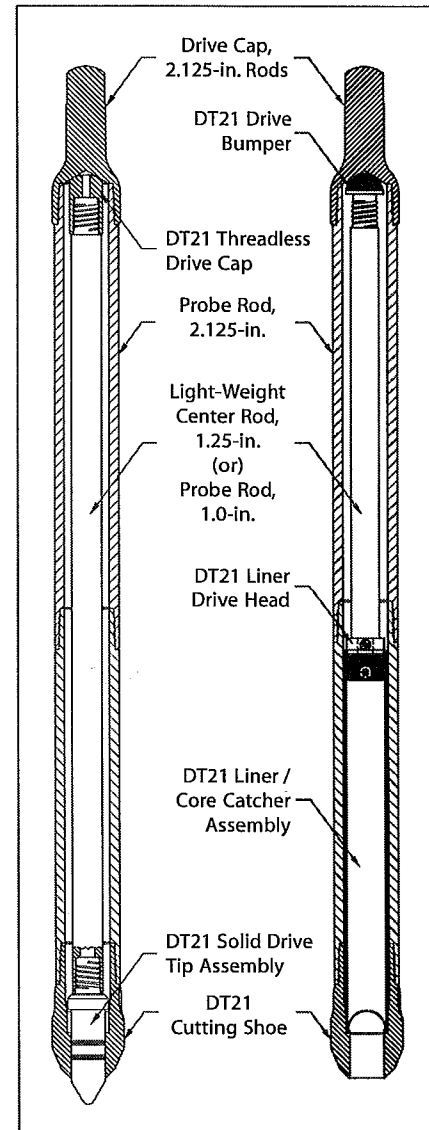

Figure 10: DT21 soil sampling tool string configurations.

The DT325 sampling system may also be used in a similar fashion to install high-integrity single-depth implants for soil gas sampling and long-term monitoring.

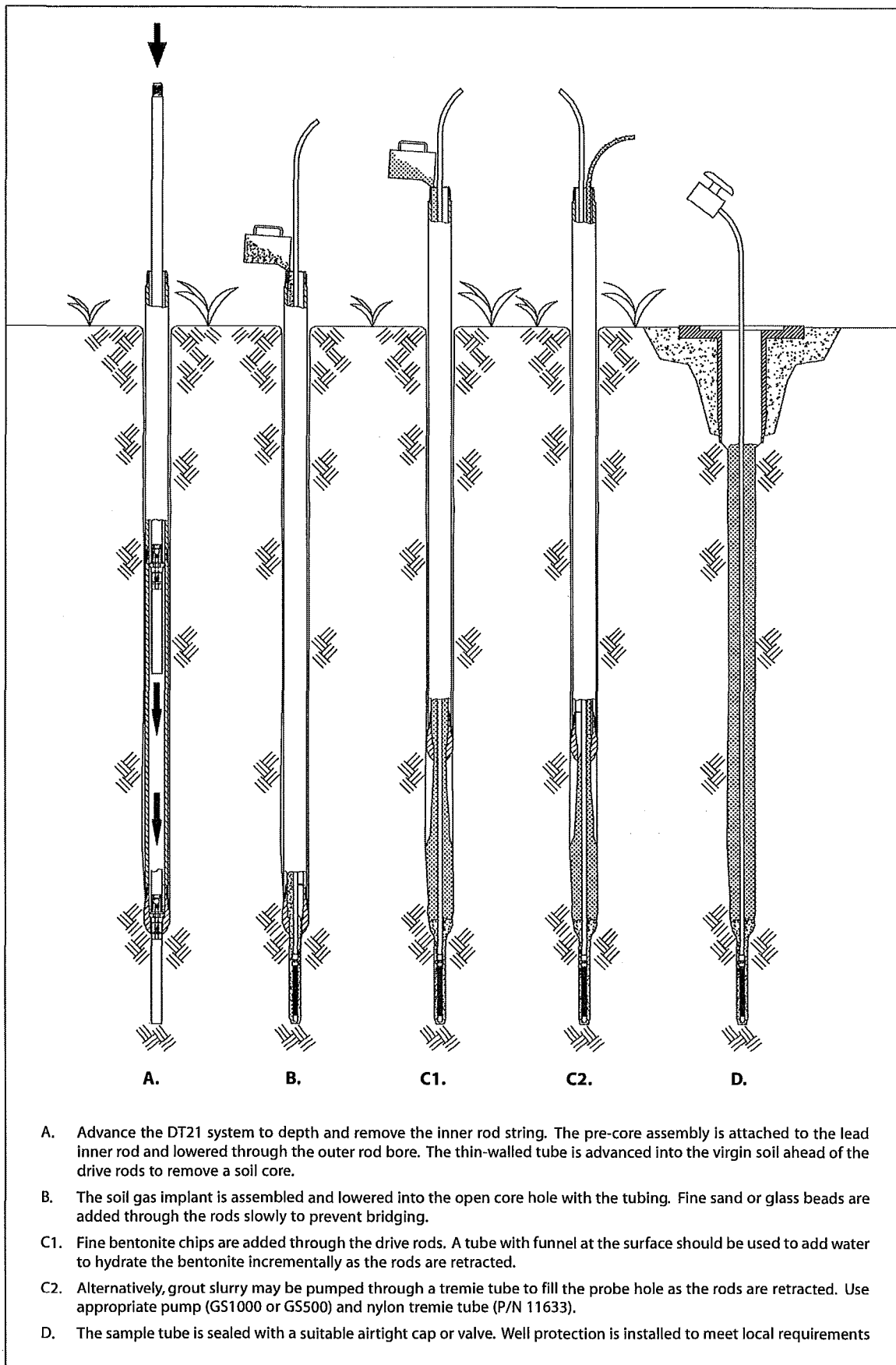

Figure 11: Installation of single-level implants for soil gas monitoring with the DT21 system.



January 15, 2019

Mr. Evan Schreiner
Wauleco, Inc.
1800 North Point Drive
Stevens Point, WI 54481

Subject: Request for Information related to the burning of wood waste
Wauleco SNE Corp., 125 Rosecrans St. Wausau, WI 54401
DNR BRRTS# 02-37-000006

Dear Mr. Schreiner:

The Wisconsin Department of Natural Resources (the "department") received information regarding burning of waste material at the former window manufacturing operation located on the Wauleco site which may have resulted in uninvestigated soil contamination. It is the department's understanding that wood waste was disposed of (burned) at a rate of up to 400 tons per month at the site and that employees of the company operating at the site could take wood scraps home and burn them.

Waste Records

The department requests information pursuant to Ch. 292.31(1)(d) Wis. Stats. regarding:

1. The type and quantity of waste generated, transported, treated or stored which was disposed of at the site or facility and the dates of these activities.
2. The identity of persons who generated, transported, treated or stored waste which was disposed of at the site or facility.
3. The identity of subsidiary or parent corporations, as defined in sub. (8) (a) 3., of persons who generated, transported, treated or stored waste which was disposed of at the site or facility.

Please provide the information related to the department's Ch. 292.31(1)(d) request within **60 days of this notification**, by March 16, 2019.

Scope of Work

To date, the Wauleco site investigation and health assessment activities have focused on soil and groundwater contamination resultant of Penta solution spills; the department is requesting a scope of work be prepared to address aerial deposition of contaminants associated with the combustion of wastes generated at the facility. The work plan must comply with the requirements in Wis. Admin. Code, chs. NR 700 through NR 754. The law requires that you appropriately scope out your site investigation and submit a work plan within **60 days of this notification**, by March 16, 2019.

All correspondence regarding this site should be directed to:

Matt Thompson
Remediation and Redevelopment Program
Wisconsin Department of Natural Resources
1300 West Clairemont Avenue
Eau Claire, WI 54701
MatthewA.Thompson@wisconsin.gov

If you have questions, please call Matt Thompson at 715-839-3750 for more information.

Thank you for your cooperation.

Sincerely,

A handwritten signature in black ink, appearing to read 'Matt Thompson', is written over a light blue horizontal line.

Matt Thompson
Hydrogeologist - Remediation & Redevelopment Program
West Central Region

cc: Bruce Iverson, TRC
Ken Quinn, TRC
David Crass, Michael Best & Friedrich, LLP