



CONSTRUCTION PLAN

PRACTICE(S) STREAMBANK AND SHORELINE STABILIZATION (ATCP 50.88/NRCS 580)

LANDOWNER STEVE SKOGE

ADDRESS [REDACTED]

LANDOWNER PHONE NO. [REDACTED] COUNTY POLK

TOWNSHIP BALSAM LAKE T 35 N, R 16 E W Sec. 20

FIELD OFFICE POLK COUNTY LWRD TELEPHONE NO. (715) 485-8699

DIGGERS HOTLINE

Call 3 Work Days
Before You Dig!

Nationwide
811

Toll Free
1-800-242-8511

TDD
1-800-542-2289

Website
www.diggershotline.com



Not to
Scale

LOCATION MAP

NOTICE TO LANDOWNERS AND EXCAVATORS

Any representation made by the USDA, Natural Resources Conservation Service, or the POLK County LCD, as to the approximate location or nonexistence of above or under ground hazards does not relieve the owner of the property or the excavator that is hired to complete construction, from notifying Diggers Hotline of the pending construction. You will be liable for damages resulting from construction activities. (Call Diggers Hotline) Ticket # _____

Landowner Acceptance: See WI Jobsheet 819

Designed by: _____ Date: _____

Checked by: _____ Date: _____

Approved by: _____ Date: _____

The installed practices comply with applicable NRCS technical standards and specifications. The "redlined" construction plans (as-built drawings) reflect changes made during construction.

Construction Approved by: _____ Date: _____

Job Approval Class (580 - III WAVE HEIGHT)

ESTIMATED QUANTITIES

ITEM	UNIT	QUANTITY	SHEET NUMBER	WI. CONSTRUCTION SPEC. OR JOB SHEET NUMBER
MOBILIZATION	JOB	1		7 – MOBILIZATION & DEMOBILIZATION
MINOR SHAPING AND GRADING – (approx. 15 C.Y.)	JOB	1	4,5	2 – EXCAVATION
CLASS 1 NON-WOVEN GEOTEXTILE FABRIC	S.Y.	240	5	13 – GEOTEXTILES
RIPRAP d50=8”	TONS	110	4,5	9 – ROCK RIPRAP
SEED (approx. 2400 square feet)	JOB	1	4,5	SEE PAGES 7 & 8 FOR SEEDING DETAILS
EROSION CONTROL BLANKET – CLASS 1 TYPE A	S.Y.	280	4-6	5 – CONSTRUCTION SITE POLLUTION CONTROL
SHRUBS – (planted at 4’ spacing)	EACH	75	4,5	SEE PAGES 7 & 8 FOR SEEDING DETAILS

Quantities are estimated to the neat lines and grades of in-place materials shown on the construction plan unless otherwise stated. Truck yardage, loose fill, shrinkage, etc., must be calculated and compensated for by the contractor preparing a bid or constructing the project.



ESTIMATED QUANTITIES

CLIENT: STEVE SKOGE
COUNTY: POLK

Designed	KBP	Date	11/21
	_____	_____	_____
Drawn	KBP	Date	11/21
	_____	_____	_____
Checked	_____	_____	_____
	_____	_____	_____
Approved	_____	_____	_____
	_____	_____	_____

Drawing Name	WI-005
Date	05/15
Sheet	2 of 9

CONSTRUCTION NOTES

1. ALL UNDERGROUND HAZARDS AND UTILITIES MUST BE INVESTIGATED PRIOR TO CONSTRUCTION. NOTIFICATION OF AFFECTED UTILITY COMPANIES IS THE RESPONSIBILITY OF THE CONTRACTOR. CONTACT DIGGERS HOTLINE AT LEAST THREE DAYS PRIOR TO START OF CONSTRUCTION.
2. A PRE-CONSTRUCTION MEETING SHALL BE SCHEDULED WITH POLK COUNTY LWRD PERSONNEL, THE CONTRACTOR, AND THE LANDOWNER PRIOR TO CONSTRUCTION START-UP.
3. THE CONTRACTOR AND/OR LANDOWNER SHALL NOTIFY POLK COUNTY LWRD AT LEAST 3 DAYS PRIOR TO START-UP OF CONSTRUCTION.
4. ALL WORK TO BE PERFORMED IN ACCORDANCE WITH WISCONSIN NRCS CONSTRUCTION SPECIFICATIONS (SEE PROJECT MANUAL).
5. INITIAL SURVEY LAYOUT WILL BE PERFORMED BY POLK COUNTY. IT IS THE CONTRACTOR'S RESPONSIBILITY TO PROVIDE ADDITIONAL GRADE STAKES DURING CONSTRUCTION AS NECESSARY, OR IF DAMAGED BY THEIR OPERATIONS.
6. ANY MATERIALS MUST BE ON-SITE AT THE TIME OF CONSTRUCTION AND MUST BE APPROVED BY THE ENGINEER/TECHNICIAN PRIOR TO INSTALLATION.
7. ALL DISTURBED AREAS SHALL BE SEEDED AS SOON AS POSSIBLE IN THE CONSTRUCTION SEQUENCE. SEED MIX TAGS SHALL BE DOCUMENTED BY THE TECHNICIAN.
8. EXISTING ROCK ON SHORELINE CAN BE USED TO SUPPLEMENT THE PROPOSED RIPRAP.
9. GEOTEXTILE FILTER FABRIC SHALL CONFORM TO WISCONSIN CONSTRUCTION SPECIFICATION 13. RIP RAP OR AGGREGATE SHALL BE PLACED IN THE MANNER DESCRIBED IN THIS SPECIFICATION AND SHALL ENSURE THAT NO DAMAGE TO THE GEOTEXTILE FABRIC OCCURS.
10. ROCK RIP RAP SHALL BE FURNISHED FROM AN APPROVED QUARRY AND SHALL MEET THE SPECIFICATIONS CONTAINED IN WISCONSIN CONSTRUCTION SPEC 9 WITH REGARDS TO SPECIFIC GRAVITY, ABSORPTION, AND SOUNDNESS. ROCK RIP RAP FROM IGNEOUS OR METAMORPHIC ORIGINS SUCH AS GRANITE, BASALT, AND QUARTZITE MAY BE USED WITHOUT TESTING.
11. ROCK GRADATION MUST BE APPROVED PRIOR TO CONSTRUCTION.
12. EROSION CONTROL BLANKET SHALL BE CLASS 1-TYPE A BIODEGRADABLE. IT SHALL BE INSTALLED AFTER SEEDING AND BEFORE PLANTING OF SHRUBS.
13. EROSION CONTROL MEASURES MAY BE REQUIRED TO ENSURE THAT BONE LAKE DOES NOT RECEIVE SEDIMENT OR OTHER MATERIAL FROM THE PROJECT SITE DURING CONSTRUCTION.
14. AVOID DISTURBANCE OF AQUATIC VEGETATION WHEREVER POSSIBLE.



CONSTRUCTION NOTES

CLIENT: STEVE SKOGE
 COUNTY: POLK

	Date	
Designed <u>KBP</u>	<u>11/21</u>	
Drawn <u>KBP</u>	<u>11/21</u>	
Checked _____		
Approved _____		

Drawing Name
Date
Sheet 3 of 8

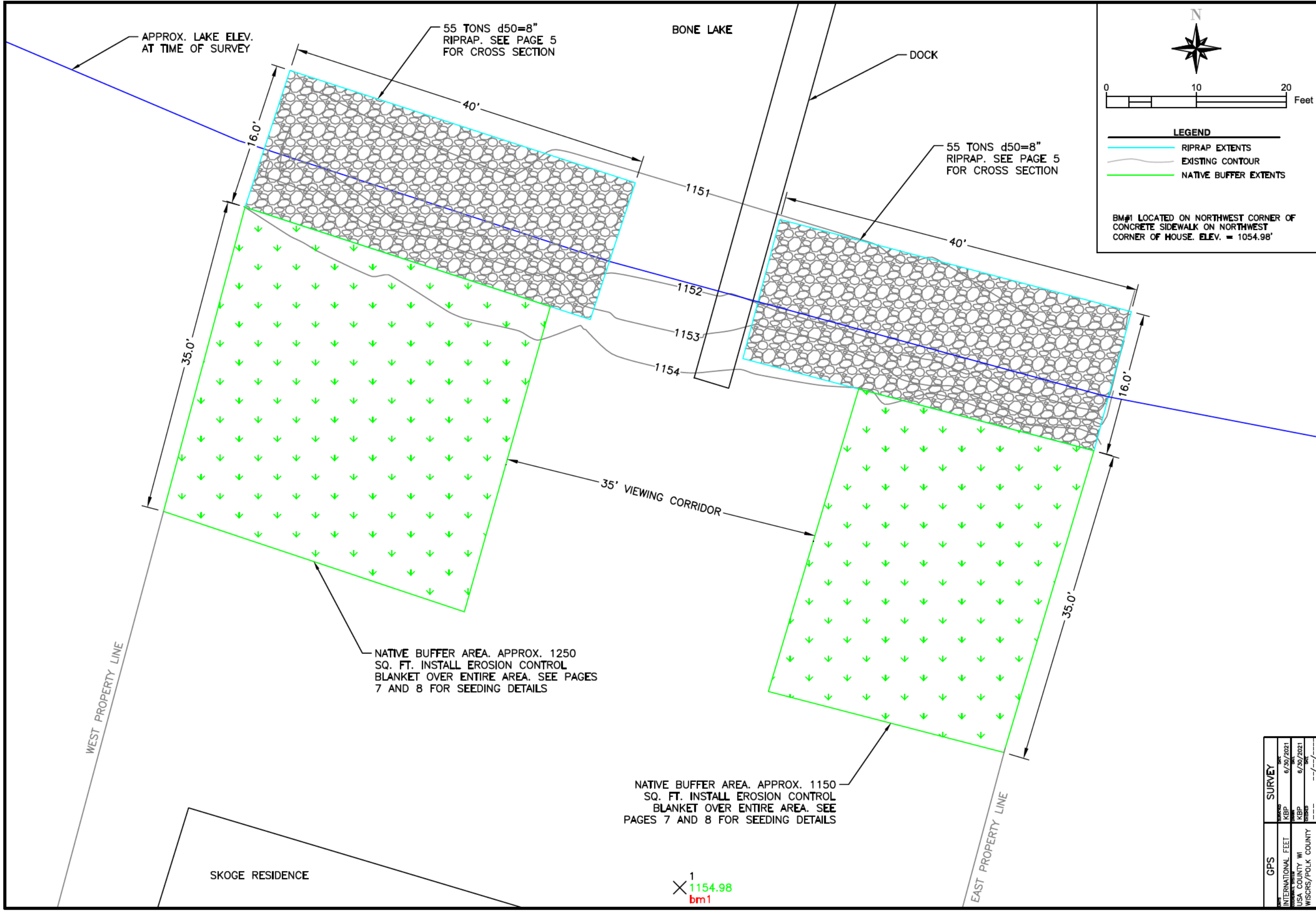

North arrow pointing up.

Scale bar: 0, 10, 20 Feet

LEGEND

- RIPRAP EXTENTS (Blue line)
- EXISTING CONTOUR (Grey line)
- NATIVE BUFFER EXTENTS (Green line)

BM#1 LOCATED ON NORTHWEST CORNER OF CONCRETE SIDEWALK ON NORTHWEST CORNER OF HOUSE. ELEV. = 1054.98'

Date

Designed	KBP	11/21
Drawn	KBP	11/21
Checked		
Approved		

PLAN VIEW

OWNER: STEVE SKOGE

COUNTY: POLK

United States Department of Agriculture

Natural Resources Conservation Service

USDA logo

GPS	SURVEY
INTERNATIONAL FEET	KBP 6/30/2021
USA COUNTY WI	KBP 6/30/2021
WISCONSIN/POLK COUNTY	KBP 6/30/2021

File Name: WI-014A

06/2018

Sheet 4 of 8

CROSS SECTION

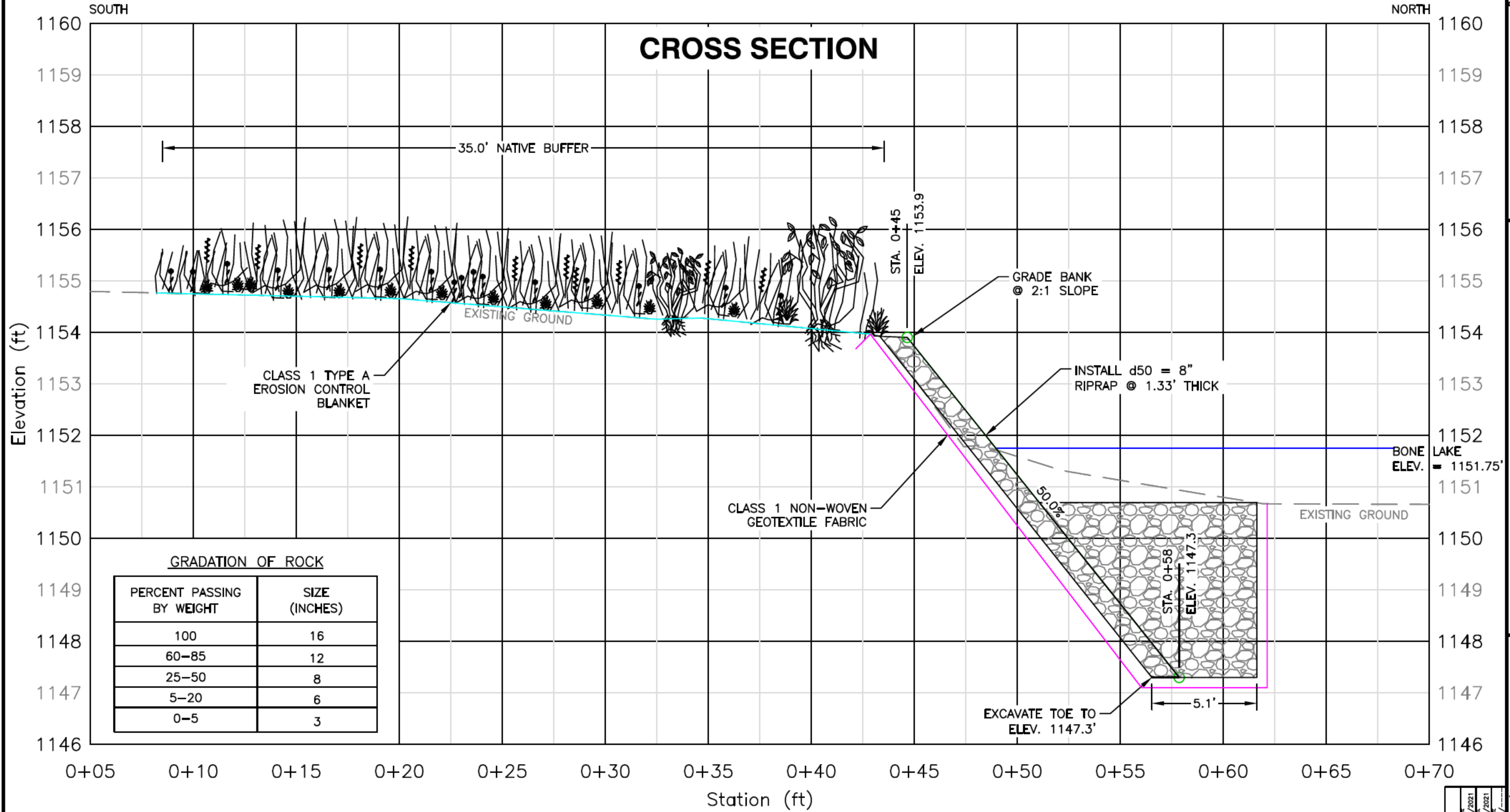

Date: 11/21
 Designed: KBP
 Drawn: KBP
 Checked: _____
 Approved: _____

CROSS SECTION VIEW

OWNER: STEVE SKOGE
 COUNTY: POLK



GPS	SURVEY
INTERNATIONAL FEET	DATE: 6/30/2021
USA COUNTY: WI	DATE: 6/30/2021
WISCONSIN/POLK COUNTY	

File Name: WI-014A
 06/2018
 Sheet 5 of 8

DRAWING NOT TO SCALE

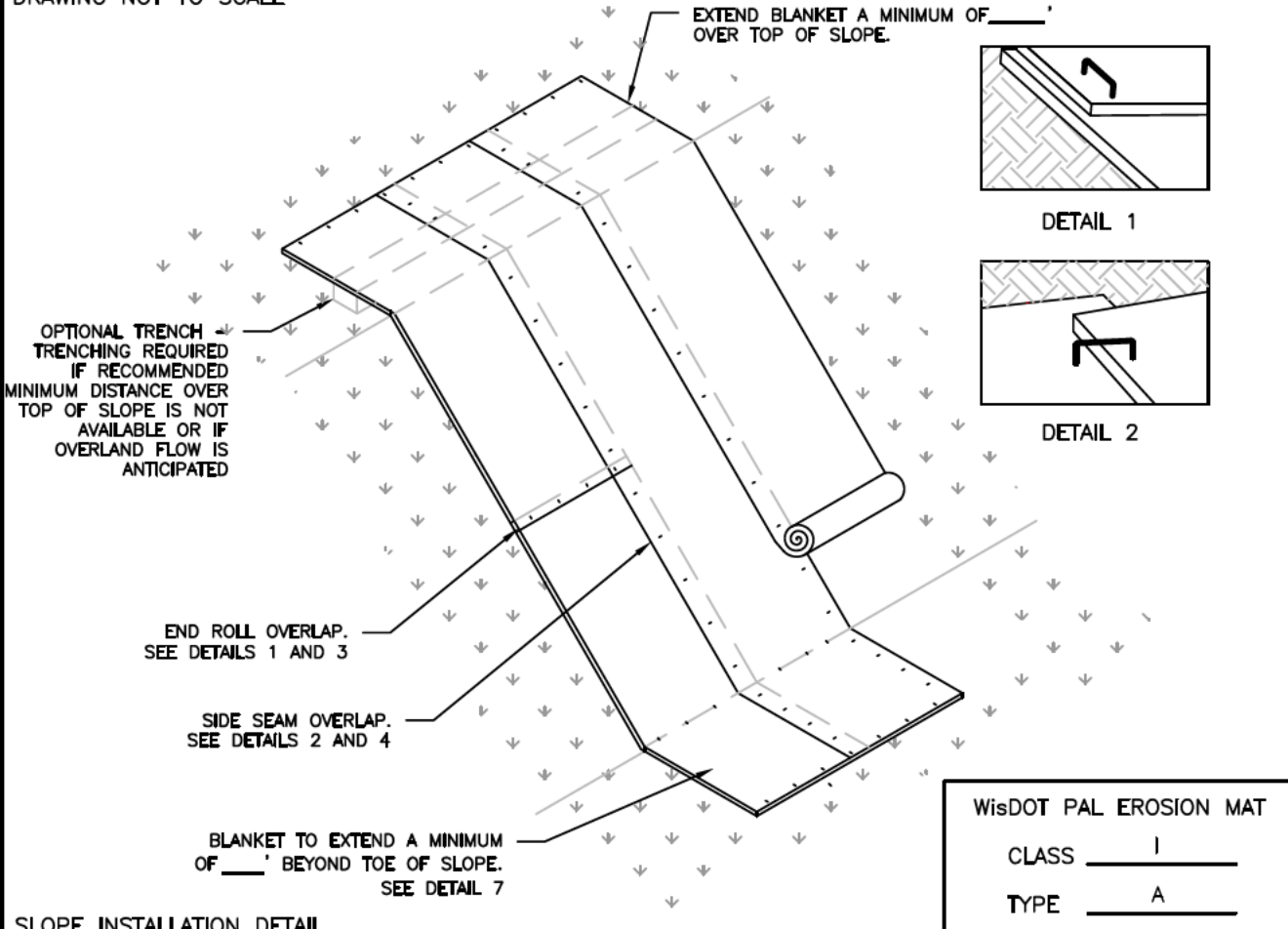

SLOPE INSTALLATION DETAIL

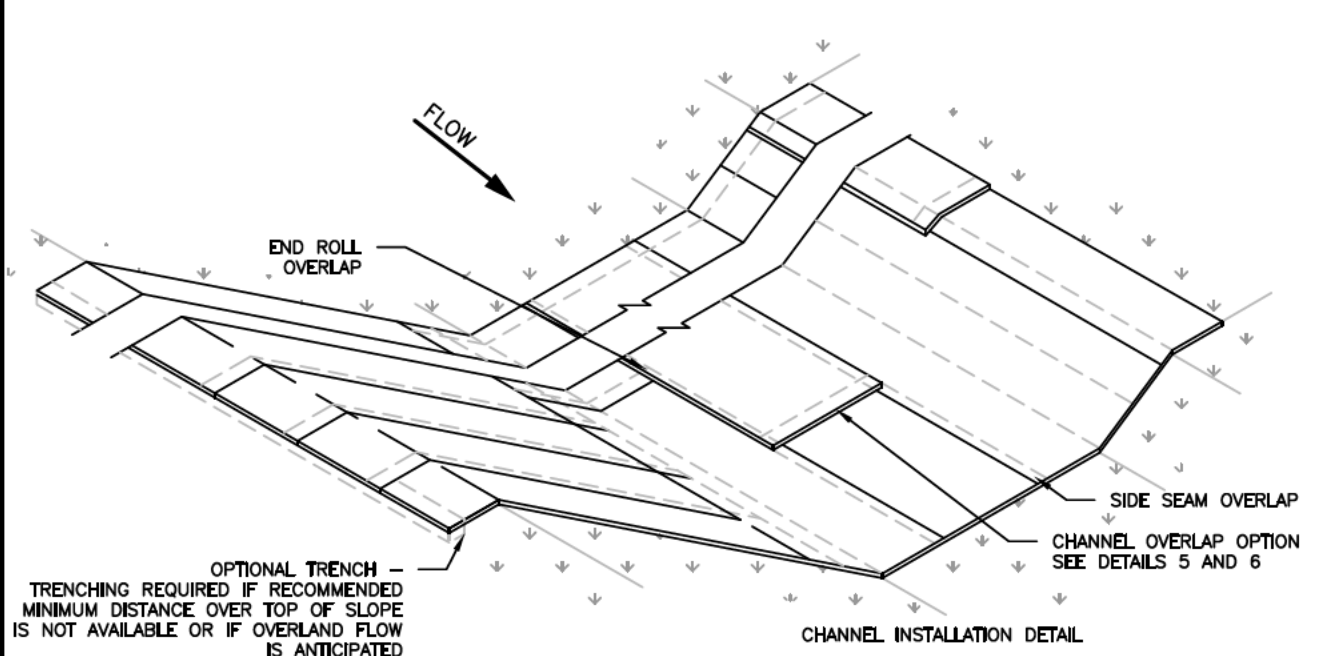

- NOTES:**
1. STAPLE PATTERNS ARE DEPENDENT UPON SLOPE CONDITIONS AND MANUFACTURER'S RECOMMENDATIONS.
 2. STAPLES OF 11 GAUGE OR HEAVIER SHALL BE USED TO HOLD MATS AND NETS IN PLACE.
 3. STAPLES SHALL BE U-SHAPED WITH A 1-INCH CROWN.
 4. STAPLE LENGTHS ARE DETERMINED BASED ON SOIL CONDITION. SEE WI STANDARD 484-MULCHING FOR STAPLE LENGTH REQUIREMENTS. STAPLES SHALL BE 6" LONG.
 5. FOLLOW MANUFACTURER'S RECOMMENDATIONS FOR BOTH END AND EDGE OVERLAP LENGTH.
 6. CONSIDER THE USE OF BIODEGRADABLE STAPLES IN LOCATIONS WHERE WIRE STAPLES ARE DETERMINED TO BE A RISK.

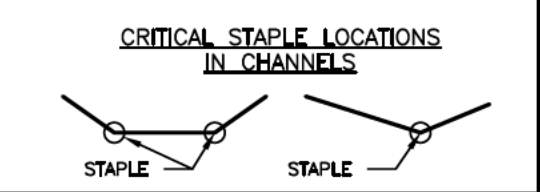
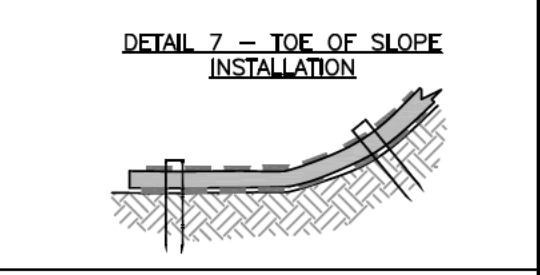
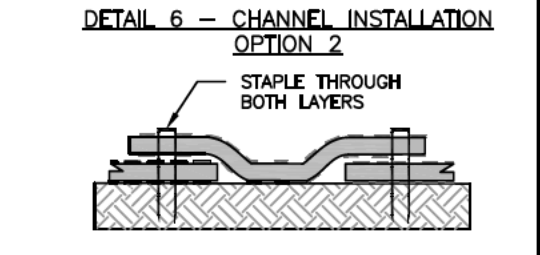
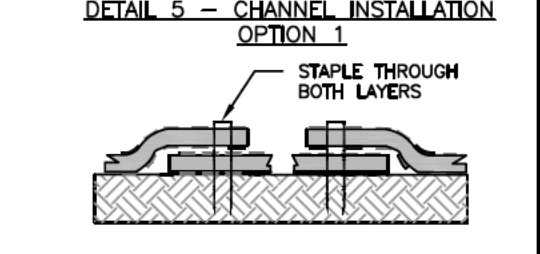
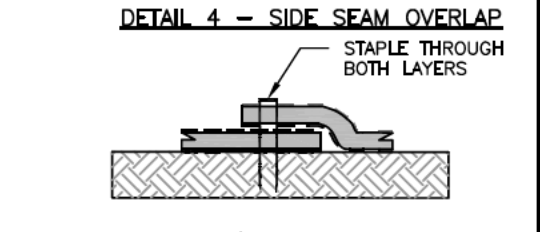
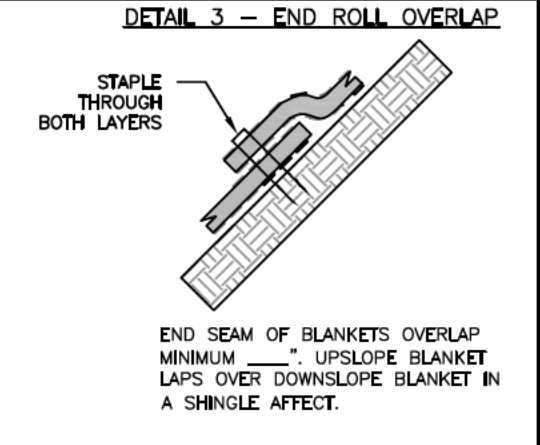
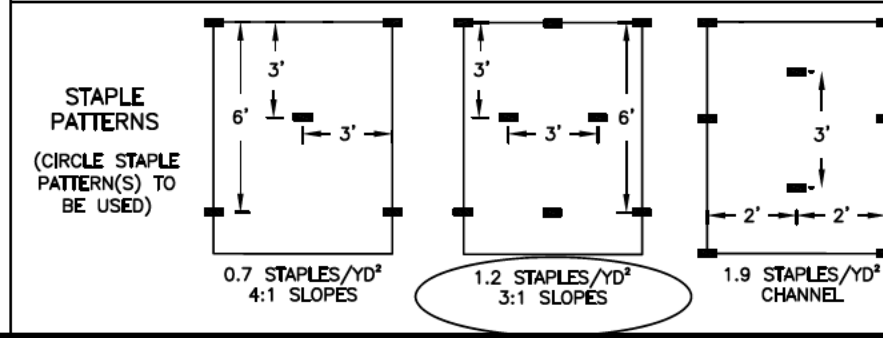
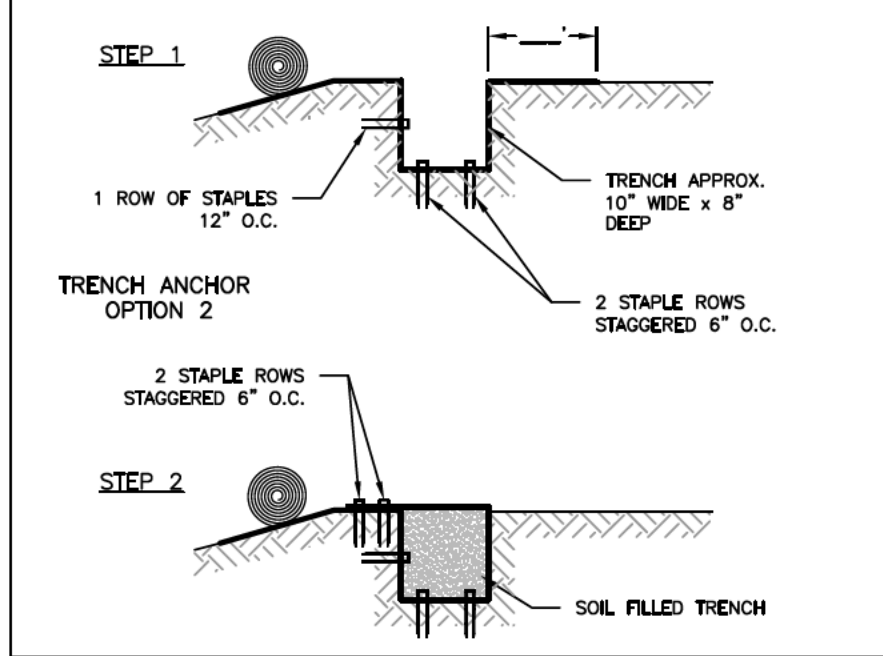
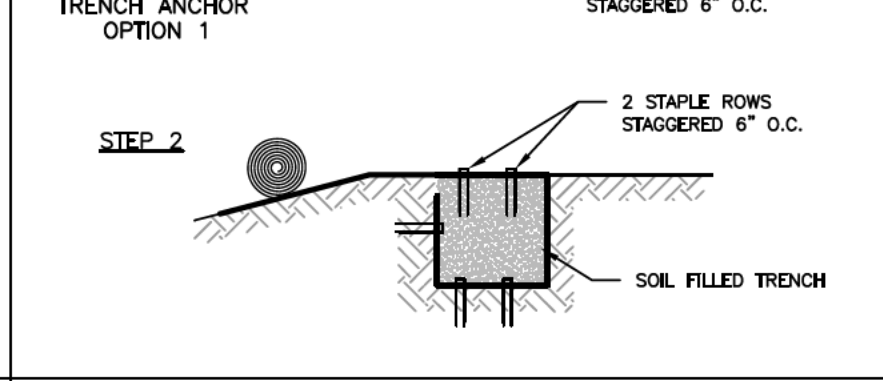
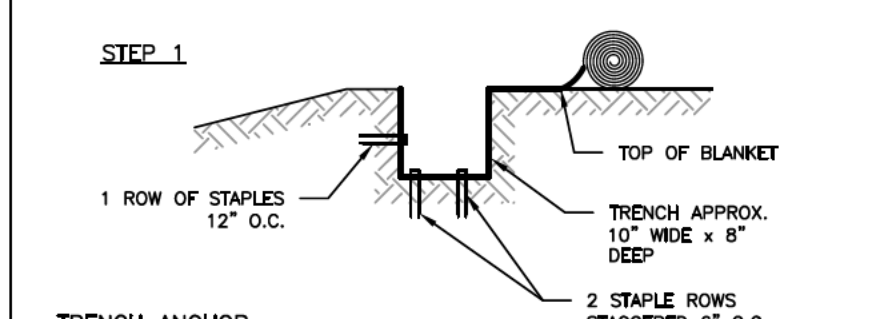
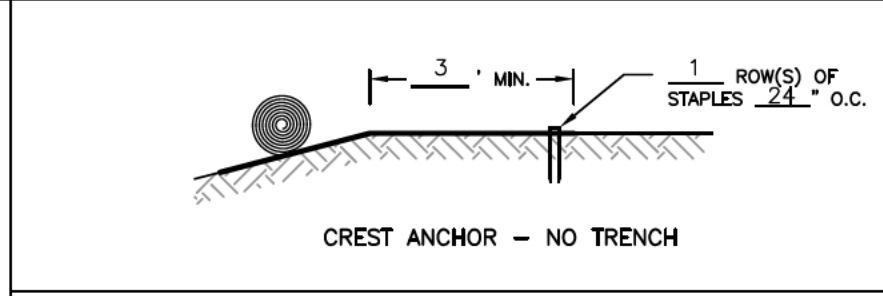

Date 11/21
 Designed KBP
 Drawn KBP
 Checked
 Approved

EROSION CONTROL MAT INSTALLATION
 OWNER: STEVE SKOGE
 COUNTY: POLK

United States Department of Agriculture
 Natural Resources Conservation Service

Drawing Name WI-790
 Date 11/2017

SEEDING DATES

TIME PERIOD	DATES			TYPE OF SEEDING
Spring	April 15	through	June 1	Permanent
Summer	June 2	through	see WI-710 pg. 2	Temporary *
Late Summer	August 1	through	August 22	Permanent
Fall	August 23	through	see WI-710 pg. 2	Temporary *
Late Fall	November 1	through	snow cover	Dormant
Winter	snow cover	through	April 14	Frost Seed Not Allowed

MATERIALS

If no soil test is available, apply a minimum of 150 pounds of 20-10-10 fertilizer per acre. This is equivalent to 30 pounds nitrogen (N), 15 pounds phosphate (P205), and 15 pounds potash (K20) per acre. Apply two tons/ac of 80-89 lime or equivalent. (see page 2 for equivalent)

* Seed a temporary cover crop of Annual Rye at a rate of 20 pounds/acre. (1/3 Bushels/acre)
 A permanent seeding shall be completed during the next acceptable time period following a temporary seeding.

MINIMUM PURE LIVE SEED (PLS)¹ RATE PER ACRE AND TOTAL POUNDS OF SEED NEEDED

SEEDING MIX <u>1</u>			LOCATION ACRES <u>0.1</u>		SEEDING MIX <u>SHRUBS</u>			LOCATION ACRES <u>0.1</u>	
SPECIES	RATE	POUNDS	SPECIES	TOTAL	SPACING				
Fox Sedge	0.3	.03	Northern Bush Honeysuckle	25	4'				
Canada Wildrye	3.0	.30	New Jersey Tea	25	4'				
Prairie Cordgrass	2.5	.25	Witch Hazel	25	6'				
Canada Milkvetch	0.1	.01							
Red Clover	0.1	.01							
Birdsfoot Trefoil	0.2	.02							
Cardinal Flower	0.03	.003							
Smooth Blue Aster	0.25	.025							
Common Ironweed	0.3	.03							
**									

1. PLS = (% Germination X % Purity)

** Companion Crop

Total % Germination may also be termed Total % Viable Seed on a tag. If a tag only shows % Germination, the user must include percentage of the seed that germinated during the lab test (% Germination) plus the percentage of hard and/or dormant seed. Hard seed and dormant seed are seeds that are still capable of germinating and producing a plant but did not germinate under the conditions of the test in the lab.

Additional native seeds may be required by permitting agencies. These additions are allowed.

Seed mixture shall meet all requirements of the WI weed laws.

Species identified as restricted or prohibited by law shall not be planted.

Certified seed shall be used, and the seeding rates will be based on pure live seed.

For dormant seedings, increase the seeds per square foot by 15%.

SEEDBED PREPARATION

Seedbed preparation shall immediately follow construction activities.

Prepare a fine, firm seedbed to a minimum depth of three inches. A seedbed is considered firm when a footprint penetrates less than 1/4 inch deep.

 United States Department of Agriculture Natural Resources Conservation Service	NATIVE SPECIES SEEDING ESTABLISHMENT		Date Designed <u>KBP</u> <u>11/21</u>	File Name WI-710
	CLIENT: <u>STEVE SKOGE</u>		Date Drawn <u>KBP</u> <u>11/21</u>	Date 12/2019
	COUNTY: <u>POLK</u>		Checked _____	Sheet 7 of 8
			Approved _____	

SEEDING

Inoculate legumes with the specific inoculum for the species in accordance with the manufacturer's recommendations. When using a hydroseeder, five times the recommended rate of inoculant shall be added to the hydroseeder. Inoculant shall not be mixed with liquid fertilizer.

Seed may be broadcast or drilled as appropriate to the site.
Seed, fertilize, and lime as soon as possible after construction.
Seeding perpendicular to direction of flow is required to limit erosion.
Seed grasses and legumes no more than 1/4 inch deep.
Consider seeding at a lower rate and making 2 passes to ensure more uniform distribution.

TEMPORARY SEEDING OPTIONS

Select one of the following species for temporary cover if:

- 1) The required seeds or plant stock are not available or the normal permanent seeding period for the species has passed
 - Forage Sorghum - 1/2 bushel per acre (May 15-July 15)
 - Sorghum - Sudangrass Hybrid - 1 bushel per acre (May 15-July 15)
 - Sudangrass - 1 bushel per acre (May 15-July 15)
 - Winter Wheat - 2 bushels per acre (Aug 1-Oct 1)
 - Winter Cereal Rye - 2 bushels per acre (Aug 1-Oct 15)
 - Oats - 2 bushels per acre (Apr 1-Sept 1)
 - Annual Ryegrass - 20 Pounds per acre (Apr 1-Sept 1)

- 2) Triazine herbicide carryover will not allow establishment of permanent cover immediately.
 - Forage Sorghum - 1/2 Bushel per acre (May 15-July 15)
 - Sorghum - Sudangrass Hybrid - 1 Bushel per acre (May 15-July 15)
 - Sudangrass - 1 Bushel per acre (May 15-July 15)

DORMANT SEEDING

Seed is broadcast and incorporated, no-tilled, or drilled into the seedbed. Seedbed preparations and conditions are similar to conventional seeding.

MULCHING (Mulching is required.) (Mulching is not required.)

Mulching shall be done immediately after seedbed preparation and seeding. Mulch shall be applied immediately after final grading for areas seeded at a later date.

Mulch material shall be relatively free of disease, pesticides, chemicals, noxious weed seeds, and other pests and pathogens.

Spread straw and hay mulch uniformly and at the rate of 1.5-2.0 tons per acre (60-70 bales). This application results in a layer of 6 to 7 stems, 1 to 2 inches thick, and provides a minimum 70% ground cover. Some soil surface can be seen after the application. Crimping (disking), wood cellulose fiber, tackifiers, netting, pinning, or other acceptable methods of anchoring will be used if needed to hold the mulch in place.

If other mulch materials are used, the rate of application shall meet the manufacturer's recommendations.

Two (2) tons/ac of 80-89 lime or equivalent from UW-EXT A3671

Lime Quality	Tons/AC.
40-49	3.9
50-59	3.2
60-69	2.7
70-79	2.3
90-99	1.9
100+	1.6



United States Department of Agriculture

Natural Resources Conservation Service

NATIVE SPECIES SEEDING ESTABLISHMENT

CLIENT: STEVE SKOGE
COUNTY: POLK

Designed	KBP	Date	11/21
Drawn	KBP	Date	11/21
Checked			
Approved			

File Name	WI-710
Date	12/2019
Sheet	8 of 8